

REV	ECN NO	APPD
A0	/	/

NOTE :
UT03FD014SX01ZA

1. Selective Plating
 S1:5u" Gold In Contact Area
 100u" Tin In Tail Area
 S2:0.8u" Gold In Contact Area
 100u" Tin In Tail Area
 S3:10u" Gold In Contact Area
 100u" Tin In Tail Area
 S4:15u" Gold In Contact Area
 100u" Tin In Tail Area
 S5:30u" Gold In Contact Area
 100u" Tin In Tail Area

- SPECIFICATION:
 1. CURRENT RATING: 5.0A MAX
 2. Withstanding Voltage: 100V AC
 3. TEMPERATURE RANGE: -30 °C ~ 85 °C
 4. CONTACT RESISTANCE: 40 MILLIONHM MAX
 5. INSULATION RESISTANCE: 100 MEGOHMS
 6. INSERTION FORCE : 5N~20N
 7. UNMATING FORCE: 8N~20N (1~1000次)
 6N~20N (10000次之后)
 8. DURABILITY: 10,000 CYCLES

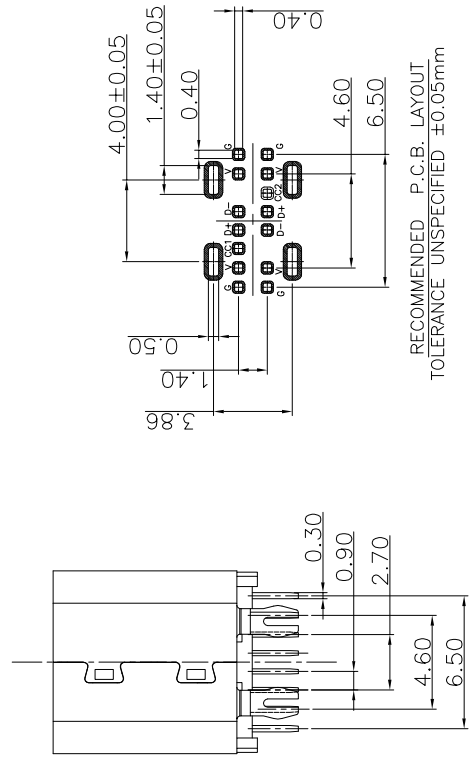
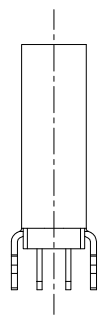
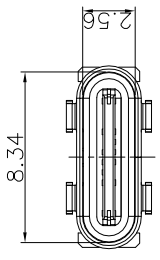
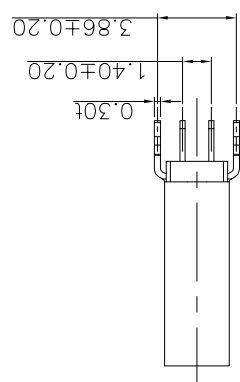
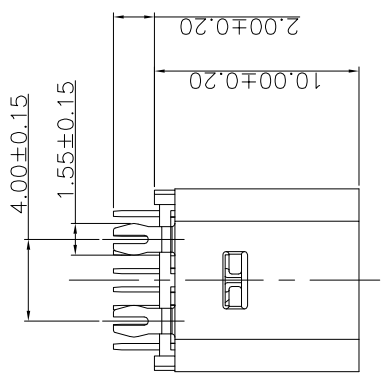
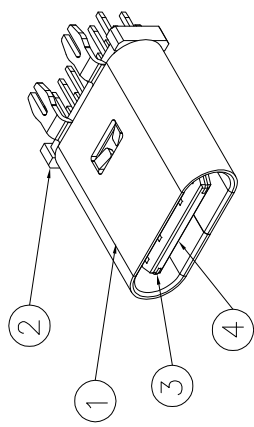

RECOMMENDED P.C.B. LAYOUT
 TOLERANCE UNSPECIFIED ±0.05mm

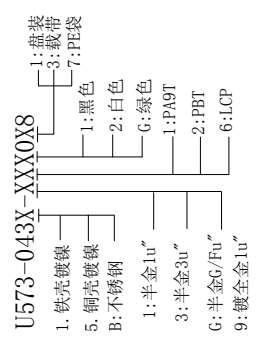

TOLERANCE UNLESS OTHERWISE SPECIFIED .XXX ±0.10 .XX ±0.20 .X ±0.30	X' ±3'	HUA LIAN WEI TECHNOLOGY ELECTRONICS CO.,LTD.
	.XX' ±2'	
APPROVED		PART NAME: TYPE C 14P 母座180度带鱼叉固定脚
CHECKED		PART No: U573-043X-XXX078
DRAWN	weihong	PROJECTION: SHEET REV.
DATE	2021.6.19	UNIT: mm SCALE: 1:1 10F1 A0