

REV.	ECN. NO.	APPD.
A	/	/

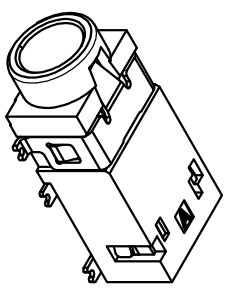

3D VIEW

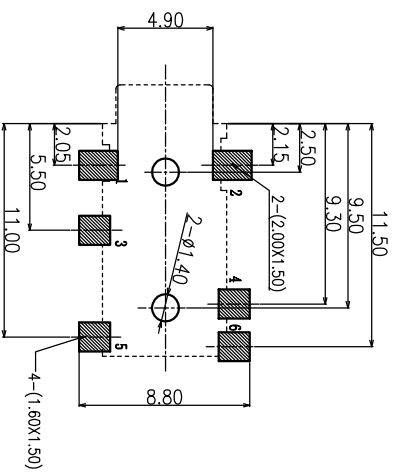
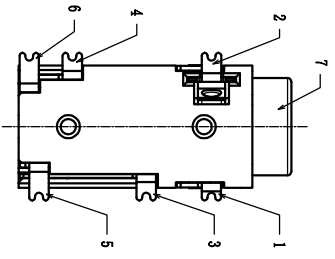

P.C.B LAYOUT
TOP VIEW

1. CONTACT CURRENT RATING: 1A.
2. CONTACT RESISTANCE: 30 mΩ MAX.;
3. INSULATION RESISTANCE: 100MΩ MIN.;
4. DIELECTRIC WITHSTANDING: 500V AC MIN.;
5. DURABILITY: 5,000 CYCLES MIN.;
6. CONNECTOR MATING FORCES: 30N MAX.;
7. CONNECTOR UNMATING FORCES: 3N MIN.;

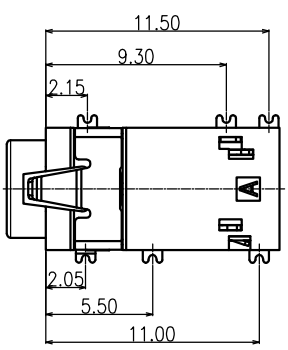
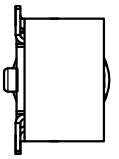
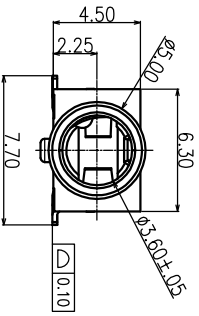
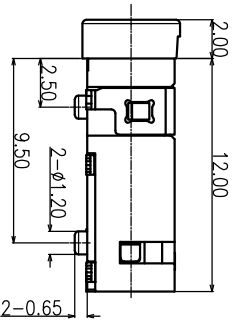

JK1-203-XXXX7

- 1: 半金1u"
 - 3: 半金3u"
 - 5: 半金5u"
 - 8: 半金15u"
 - 9: 镀全金1u"
 - G: 半金G/Fu"
- 1: PA66
 - 2: PBT
 - 3: LCP
- 1: 黑色
 - 2: 白色
 - 3: 米黄色

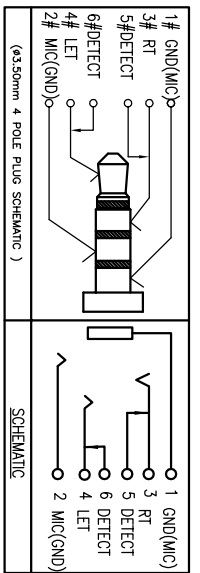

1# GND(MIC)	1 GND(MIC)
3# RT	3 RT
5# DETECT	5 DETECT
6# DETECT	6 DETECT
4# LET	4 LET
2# MIC(GND)	2 MIC(GND)

(ø3.50mm 4 POLE PLUG SCHEMATIC)

TOLERANCE UNLESS OTHERWISE SPECIFIED		HUA LIAN WEI TECHNOLOGY ELECTRONICS CO.,LTD.	
XXX ±0.10	X' ±3'	HLW 深圳市华联威电子科技有限公司 HUA LIAN WEI TECHNOLOGY ELECTRONICS CO.,LTD.	
XX ±0.20	XX' ±2'		
X ±0.30	XX' ±2'		
APPROVED		PART NAME:	耳机 JACK 6脚贴片高度4.5
CHECKED		PART NO.:	JK1-203-0217
DRAWN	weihong	PROJECTION:	
DATE	2021.11.06	UNIT:	mm
		SCALE	1:1
		SHEET	10F1
		REV.	A

9 8 7 6 5 4 3 2 1