

REV.	ECN.NO.	APPD.
A	XXXXXXXXXX	yangguifeng

- Specifications:
1. Rated Voltage : 125V AC/DC
 2. Rated Current : 1A AC,DC
 3. Withstand Voltage : 200V AC/minute
 4. Contact Resistance : 50mΩ(MAX.)
 5. Insulation Resistance : 100MΩ(MIN.)
 6. Storage Temperature Range: -40°C~+85°C;
 7. Operation Temperature Range: -25°C~+70°C;

216104-1088-G63018
 G: 半金G/Fu^z 1: 吸塑盒
 6: LCP 3: 米黄色

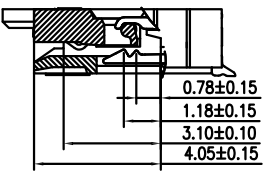
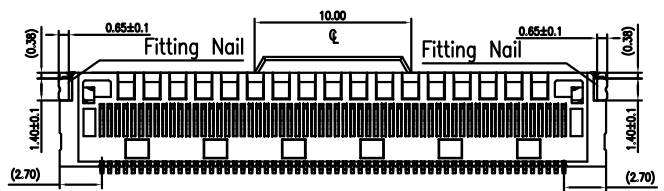
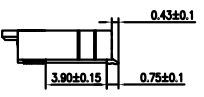
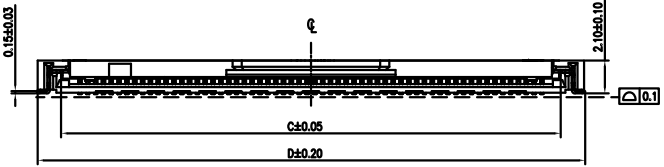
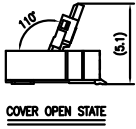
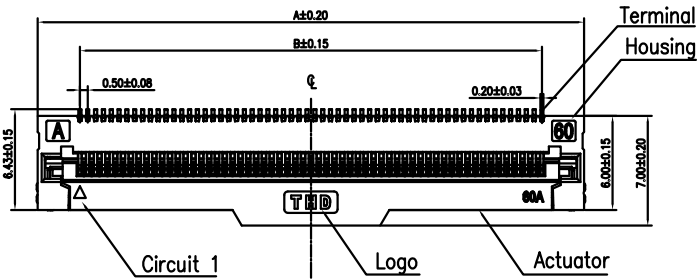

CABLE INSERT DIM.
SCALE 2:1

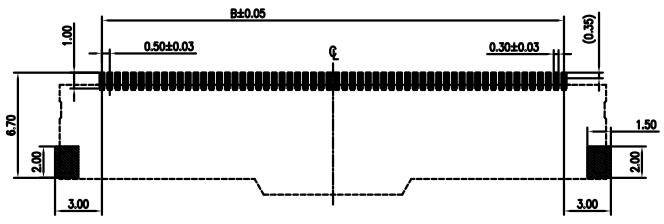

RECOMMENDED PCB PATTERN DIM.
TOLERANCE : ±0.05

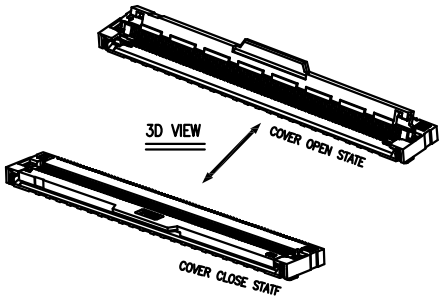

NO. of contacts	Dimensions				NO. of contacts	Dimensions			
	A	B	C	D		A	B	C	D
40	24.90	19.50	21.90	24.93	69	39.40	34.00	36.40	39.43
41	25.40	20.00	22.40	25.43	70	39.90	34.50	36.90	39.93
42	25.90	20.50	22.90	25.93	71	40.40	35.00	37.40	40.43
43	26.40	21.00	23.40	26.43	72	40.90	35.50	37.90	40.93
44	26.90	21.50	23.90	26.93	73	41.40	36.00	38.40	41.43
45	27.40	22.00	24.40	27.43	74	41.90	36.50	38.90	41.93
46	27.90	22.50	24.90	27.93	75	42.40	37.00	39.40	42.43
47	28.40	23.00	25.40	28.43	76	42.90	37.50	39.90	42.93
48	28.90	23.50	25.90	28.93	77	43.40	38.00	40.40	43.43
49	29.40	24.00	26.40	29.43	78	43.90	38.50	40.90	43.93
50	29.90	24.50	26.90	29.93	79	44.40	39.00	41.40	44.43
51	30.40	25.00	27.40	30.43	80	44.90	39.50	41.90	44.93
52	30.90	25.50	27.90	30.93	81	45.40	40.00	42.40	45.43
53	31.40	26.00	28.40	31.43	82	45.90	40.50	42.90	45.93
54	31.90	26.50	28.90	31.93	83	46.40	41.00	43.40	46.43
55	32.40	27.00	29.40	32.43	84	46.90	41.50	43.90	46.93
56	32.90	27.50	29.90	32.93	85	47.40	42.00	44.40	47.43
57	33.40	28.00	30.40	33.43	86	47.90	42.50	44.90	47.93
58	33.90	28.50	30.90	33.93	87	48.40	43.00	45.40	48.43
59	34.40	29.00	31.40	34.43	88	48.90	43.50	45.90	48.93
60	34.90	29.50	31.90	34.93	89	49.40	44.00	46.40	49.43
61	35.40	30.00	32.40	35.43	90	49.90	44.50	46.90	49.93
62	35.90	30.50	32.90	35.93	91	50.40	45.00	47.40	50.43
63	36.40	31.00	33.40	36.43	92	50.90	45.50	47.90	50.93
64	36.90	31.50	33.90	36.93	93	51.40	46.00	48.40	51.43
65	37.40	32.00	34.40	37.43	94	51.90	46.50	48.90	51.93
66	37.90	32.50	34.90	37.93	95	52.40	47.00	49.40	52.43
67	38.40	33.00	35.40	38.43	96	52.90	47.50	49.90	52.93
68	38.90	33.50	35.90	38.93	97	53.40	48.00	50.40	53.43

TOLERANCE UNLESS OTHERWISE SPECIFIED		深圳市华联威电子科技有限公司 HUA LIAN WEI TECHNOLOGY ELECTRONICS CO;LTD.				
.XXX ±0.10	.X' ±3'	PART NAME:	FPC 2.2间距0.5 60P			
.XX ±0.20	.XX' ±2'	CHECKED	PART No:	216104-1088-G63018	C	
.X ±0.30		DRAWN yangguifeng	PROJECTION:	UNIT: mm	SCALE: 1:1	SHEET: 1 OF 1
DATE: 2021.12.01						REV. A