

REV.	ECN.NO.	APPD.
A	/	LXQ

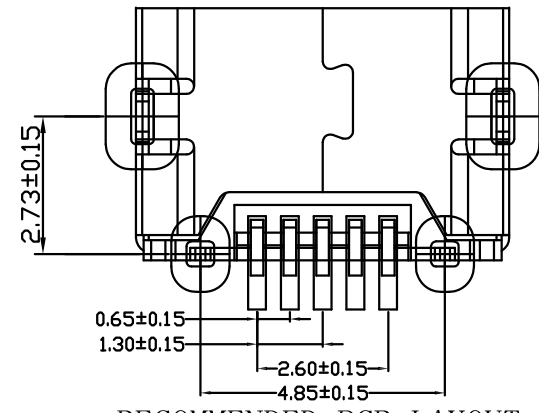

RECOMMENDED PCB LAYOUT

- NOTES:
- MATERIAL:
 - Housing: thermoplastic plastics,
 - terminals: Copper Alloy
Gold plated overall
 - Shell: Steel & Copper Alloy
Nickel/Tin Plated overall
 - ELECTRICAL CHARACTERISTICS:
 - Rating Current :1.5 Ampere
 - Rating Voltage :30 V Max
 - Contact Resistance:50 Milli ohms
 - Insulation Resistance:100 Mega ohms Min.
 - MECHANICAL CHARACTERISTICS:
 - Connector Mating force: 35N MAX
 - Connector Unmating force:7N min
 - ENVIRONMENT CHARACTERISTICS:
 - Operating temperature:-0°C to +50°C
 - Storage temperature:-20°C to +60°C

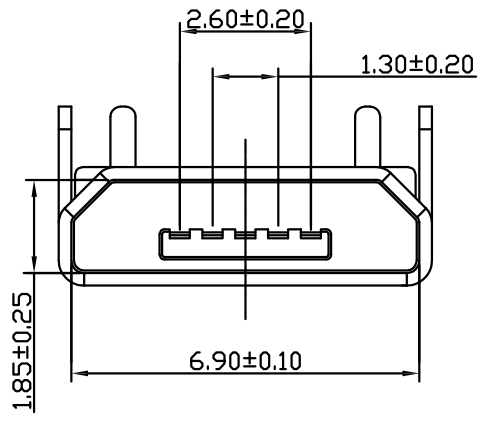
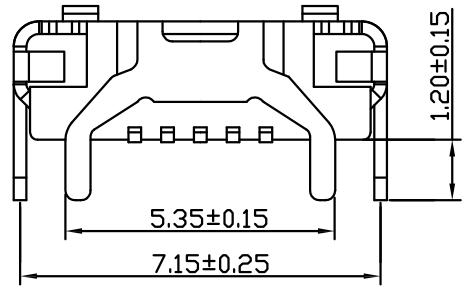
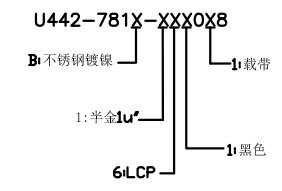
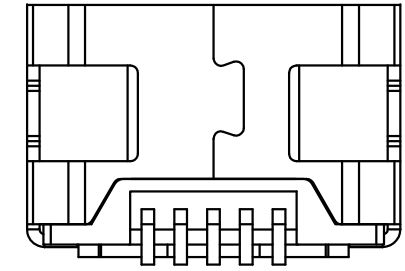
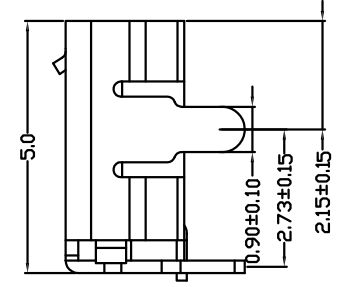
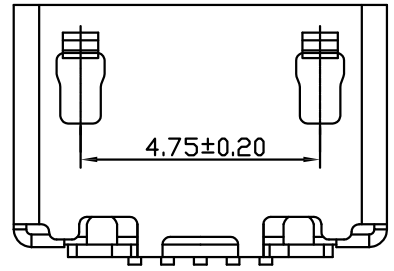

TOLERANCE UNLESS OTHERWISE SPECIFIED		FLW 深圳市华联威电子科技有限公司				
		HUA LIAN WEI TECHNOLOGY ELECTRONICS CO;LTD.				
.XXX ±0.10	.X' ±3'	PART NAME:		MICRO 5P/F 牛角无卷边		
.XX ±0.20	.XX' ±2'	PART No:		U442-781B-161018		C
.X ±0.30		DRAWN	leixianqiang	PROJECTION:	UNIT:	SCALE
		DATE	2021.10.06		mm	1:1
					SHEET	REV.
					1 OF 1	A