

REV.	ECN.NO.	APPD.
A	/	/

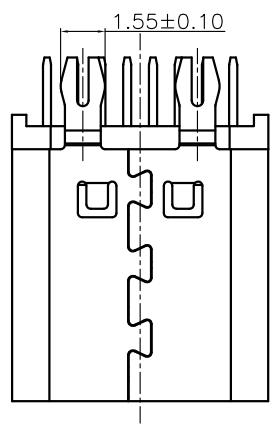

- NOTES:
- MATERIAL:
 - Housing:thermoplastic plastics
 - terminals:Copper Alloy
Gold plated in contact area:
Tin plated in termination
Nickel Plated overall
 - Shell:Steel&Copper Alloy
Nickel/Au Plated overall
 - characteristics:
 - Rating Voltage : 30V AC.
 - Rating Current:
5A for Vbus PIN;1.25A for Vconn PIN
 - Contact Resistance:40 mΩ MAX.
 - Insulation Resistance:100 MΩ MIN.
 - Withstanding Voltage:AC 100V
 - Mating force: 5~20N MAX
 - Extraction force:8~20N Min
 - Life test:10000Cycles MIN.
 - Temperature Range: -30℃~+80℃.
- The product must be compliance ROHS

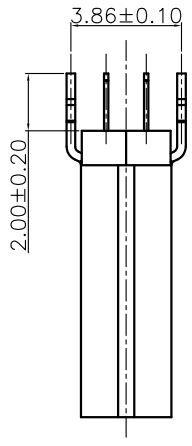
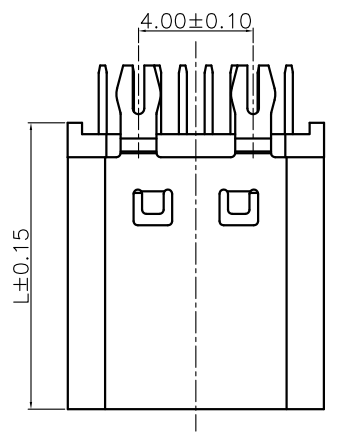
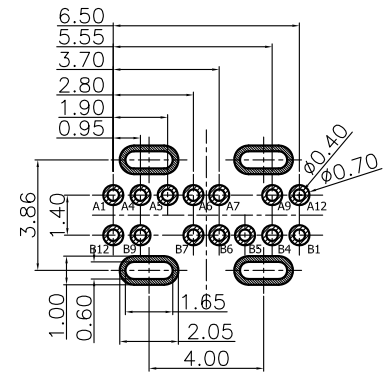
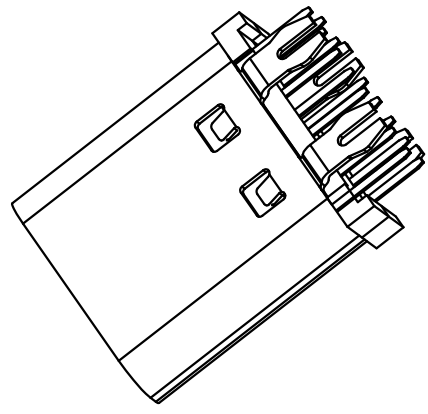
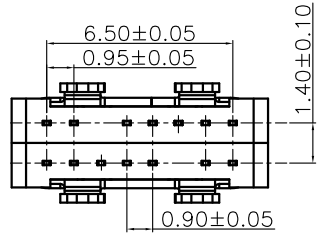
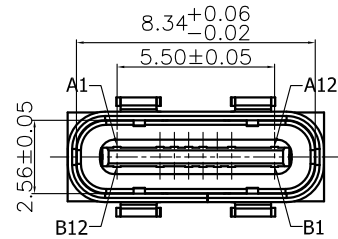

L	10.0	10.5
---	------	------

U573-097X-XXX018
 B: 不锈钢镀镍
 G: 半金G/Fu
 6:LCP
 1: 黑色

A1	A2	A3	A4	A5	A6	A7	A8	A9	A10	A11	A12
GND	/	/	VBUS	CC1	D+	D-	/	VBUS	/	/	GND
GND	/	/	VBUS	/	D-	D+	CC2	VBUS	/	/	GND
B12	B11	B10	B9	B8	B7	B6	B5	B4	B3	B2	B1

TOLERANCE UNLESS OTHERWISE SPECIFIED		HLW 深圳市华联威电子科技有限公司			
.XXX ±0.10 .XX ±0.20 .X ±0.30		HUA LIAN WEI TECHNOLOGY ELECTRONICS CO;LTD.			
APPROVED		PART NAME:	TYPE C 14PIN 立插鱼叉脚高度10.5		
CHECKED		PART No:	U573-097B-G61018	C	
DRAWN	weihong	PROJECTION:	UNIT:	SCALE	SHEET
DATE	2021.11.06		mm	1:1	10F1
				REV.	A