

## 承 认 书

Approval Sheet

客户 (Customer): /

客户料号 (Cus .P/N): /

华联威料号 (HLW P/N): R11120-100G08

品名规格 (PronameSpec): RJ11-6P6C 带屏蔽无弹

送样日期 (Delivery Date): 2021/12/15

承认日期 (Acknowledge Date): 2021/12/15

|   |                  |                           |                    |
|---|------------------|---------------------------|--------------------|
| Approved No:  |                  | 客 户<br>Customer           |                    |
| 采 购 部<br>Purchasing Dept  | 品 质 部<br>QC Dept | 工 程 部<br>Engineering Dept | 确 认<br>Approved By |
|   |                  |                           |                    |
| 深 圳 市 华 联 威 电 子 科 技 有 限 公 司<br>SHEN ZHEN SHI HUA LIAN WEI ELECTRONICS TECHNOLOGY CO; LTD. |                  |                           |                    |
| 业 务 部<br>Sales Dept   | 品 管 部<br>QC Dept | 工 程 部<br>Engineering Dept | 核 准<br>Checked By  |
| 将成英   | 欠必锋              | 魏红                        | 唐竹君                |

地址: 深圳市龙华区观澜街道桂香社区观澜桂花路 307 号

TEL: 0755-28888886 28888866

hua@hlwconn.com

[Http://www.hlwconn.com](http://www.hlwconn.com)

# 目 录

## Contents

|             |           |
|-------------|-----------|
| 图纸.....     | Page03    |
| 产品规格书.....  | Page04-09 |
| 产品检测报告..... | Page10-11 |
| 尺寸测试报告..... | Page12    |
| 电镀报告.....   | Page13-14 |
| 盐雾报告.....   | Page15    |
| 材质证明.....   | Page16-17 |
| SGS.....    | Page18-51 |

RoHS

|      |         |       |
|------|---------|-------|
| REV. | ECN.NO. | APPD. |
| AO   | NEW DWG | LJF   |

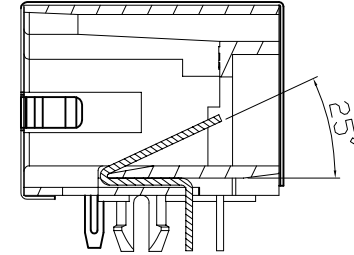
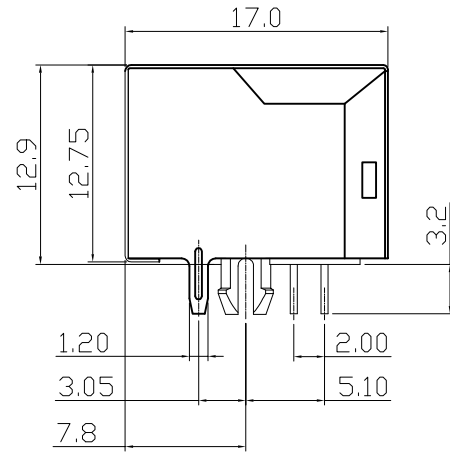
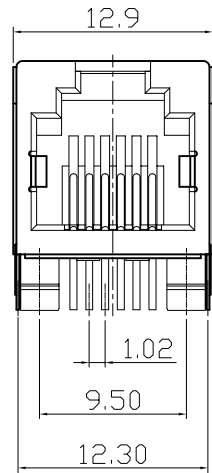

NOTES:

- 1.MATERIAL:
  - 1.1 Housing:thermoplastic plastics
  - 1.2 terminals:Copper Alloy  
Gold plated in contact area:  
OR Gold Plated overall
  - 1.3 Shell:Steel&Copper Alloy  
Nickel/Tin Plated overall
- 2.ELECTRICAL CHARACTERISTICS:
  - 2.1 Rating Current :1.5 Ampere
  - 2.2 Rating Voltage :125 V Max
  - 2.3 Contact Resistance:50 Milli ohms
  - 2.4 Insulation Resistance:500 Mega ohms Min.
- 3.MECHANICAL CHARACTERISTICS:
  - 3.1 Connector Mating force: 2.27kgf MAX
  - 3.2 Durability:750Cycles.
- 4.ENVIRONMENT CHARACTERISTICS:
  - 4.1 Operating temperature:-40℃ to +85℃
  - 4.2 Storage temperature:-10℃ to +40℃

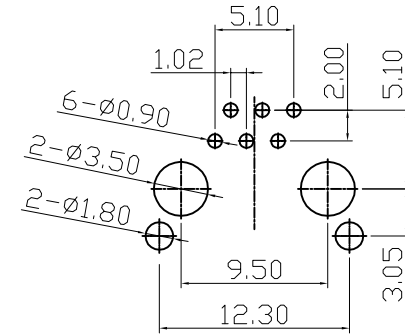
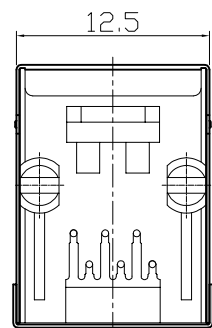

Recommend PCB Layout  
(Jack Top View)  
Tolerance: ±0.05mm  
Recommend PCB Thickness: 1.6mm

R11120-100G08  
1:铜壳镀镍  
8:防火  
G:C5191金线G/Fu”  
0:PBT黑色

|           |      |                       |                 |        |
|-----------|------|-----------------------|-----------------|--------|
| SHELL     | 1    | BRASS T=0.2mm         | Ni PALTING      |        |
| TERMINAL  | 6    | PHOSPHOR BRONZE ø0.46 | Au PALTING      |        |
| HOUSING   | 1    | PBT UL94V-0           | BLACK           |        |
| PART NAME | Q'TY | MATERIAL              | PLATING & COLOR | Remark |

|                                      |            |   |                 |       |         |
|--------------------------------------|------------|---|-----------------|-------|---------|
| TOLERANCE UNLESS OTHERWISE SPECIFIED |            | <b>FLW</b> 深圳市华联威电子科技有限公司                   |                 |       |         |
| .XXX ±0.10                           |            | HUA LIAN WEI TECHNOLOGY ELECTRONICS CO;LTD. |                 |       |         |
| .XX ±0.20                            |            |   |                 |       |         |
| .X ±0.30                             |            |   |                 |       |         |
| APPROVED                             |            | PART NAME:                                  | RJ11 6P6C 带屏蔽无弹 |       |         |
| CHECKED                              |            | PART No:                                    | R11120-100G08   |       | C       |
| DRAWN                                | Deng Shan  | PROJECTION:                                 | UNIT:           | SCALE | SHEET   |
| DATE                                 | 2020.08.17 |   | mm              | 1:1   | 10F1    |
|                                      |            |   |                 |       | REV. AO |

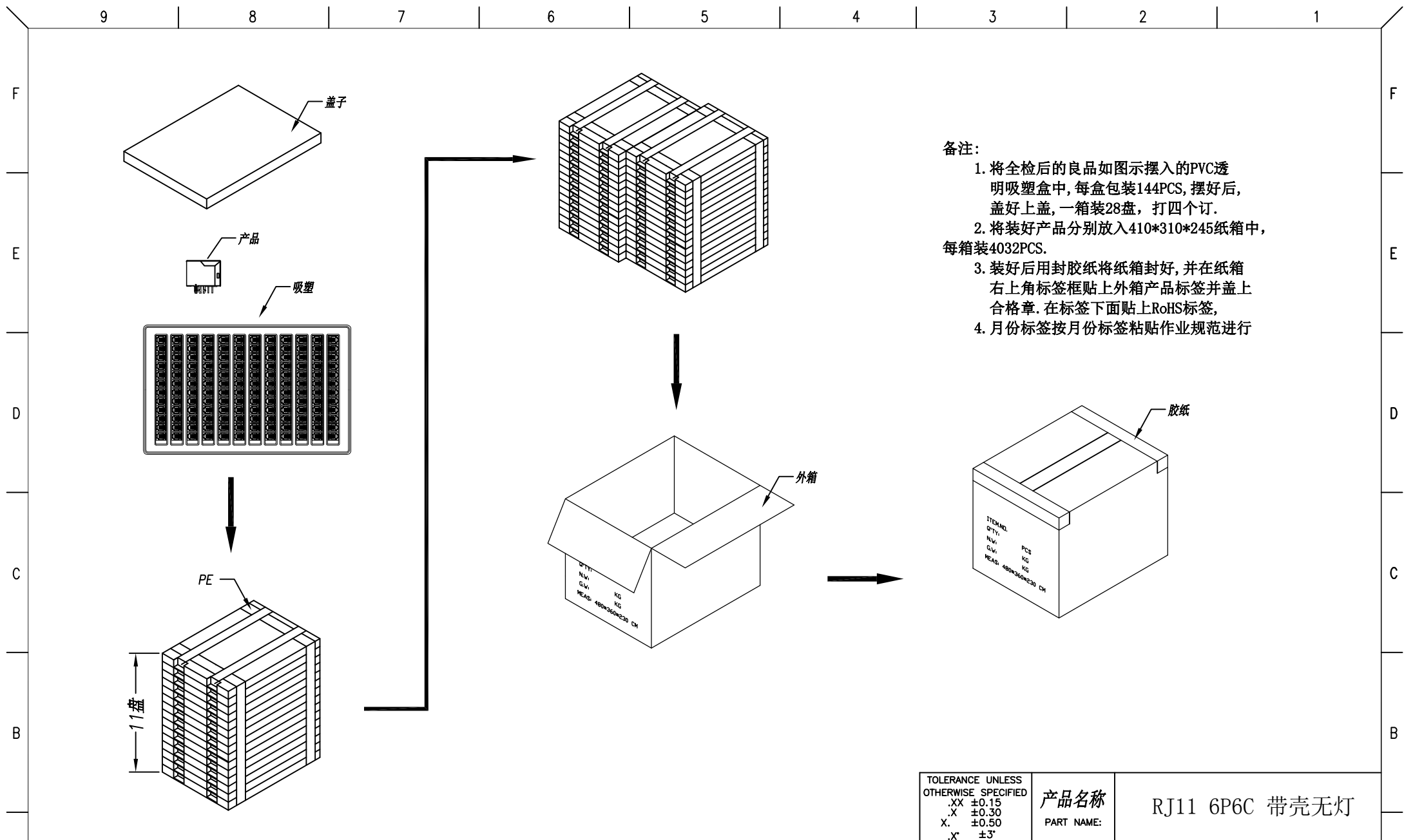

- 备注:
1. 将全检后的良品如图示摆入的PVC透明吸塑盒中, 每盒包装144PCS, 摆好后, 盖好上盖, 一箱装28盘, 打四个订.
  2. 将装好产品分别放入410\*310\*245纸箱中, 每箱装4032PCS.
  3. 装好后用封胶纸将纸箱封好, 并在纸箱右上角标签框贴上外箱产品标签并盖上合格章. 在标签下面贴上RoHS标签,
  4. 月份标签按月份标签粘贴作业规范进行

|   |  |                |   |
|---|--|----------------|---|
| TOLERANCE UNLESS OTHERWISE SPECIFIED<br>.XX ±0.15<br>.X ±0.30<br>X ±0.50<br>.X' ±3' | 产品名称<br>PART NAME:   | RJ11 6P6C 带壳无灯 |   |
|   | 料号   | R11120-100G08  | P |
|   | 图号   | B-1054         |   |
|   | <b>HLW</b> 深圳市华联威电子科技有限公司<br>HUA LIAN WEI TECHNOLOGY ELECTRONICS CO;LTD. |                |   |

|      |             |        |          |            |             |                        |          |
|------|-------------|--------|----------|------------|-------------|------------------------|----------|
| REV: | DESCRIPTION | REV BY | APPROVED | DATE       | MATL:       | SEE SPECIFICATION      | APPROVED |
| A    |             |        |          |            | PROJECTION: | THIRD ANGLE PROJECTION | CHECKED  |
| B    | 更改包装数量      | B      | weihong  | 2021.09.22 | UNIT:       | SCALE                  | REV(NO)  |
| A    | NEW DOWN    | A      | weihong  | 2021.08.11 | mm          | 1:1                    | B        |
|      |             |        |          |            |             | SHEET                  | DRAWN    |
|      |             |        |          |            |             | 1 OF 1                 | DATE     |

## RJ45/RJ11系列产品SPEC

版本版次: C

制定日期 20200707

适用范围 通用

## 1. Scope (范围)

## 1.1 Contents(内容)

This specification covers the performance, tests and quality requirements for the Electronics RJ45 Connector.  
(此份产品规格适用于RJ45连接器的产品功能, 测试方法及质量要求)

## 2. Requirements (要求):

## 2.1 Rating(额定条件)

A. Voltage rating(额定电压):125V AC

B. Current rating(额定电流):0.5A

C. Operation Temperature Range(操作温度范围):-30°C to +80°C

## 3. Test Condition(测试条件):

3.1 Temperature range(温度范围):-15°C to +35°C

3.2 Humidity range (湿度范围):25% to 85%

## 4. Test Methods and Requirements:(测试方法及要求)

## 4.1 Examination of product (产品外观)

|       |                                |                               |  |
|-------|--------------------------------|-------------------------------|--|
| 4.1.1 | Examination of Product<br>产品外观 | (EIA-364-18B)<br>Visual<br>目视 | No peeling off the plating deformation of the base or damage.<br>不得有电镀层剥落, 塑料变形或破损 |
|-------|--------------------------------|-------------------------------|--|

## 4.2. Electrical Performance(电气性能)

|       |  |  |   |
|-------|--|--|---|
| 4.2.1 | Contact Resistance<br>接触阻抗               | EIA-364-23C<br>Subject mated contacts assembled housing to 20mV maximum 100Ma. Measured from plug side to PCB side.<br><br>组装好的端子施以最大电压20mV最大电流100mA从端口处到PCB端测试。 | 40mΩ Max (Initial)<br>50 mΩ Max(Final)<br><br>初始值最大40mΩ.<br>最终值最大50 mΩ. |
| 4.2.2 | Dielectric Withstanding Voltage<br>(耐电压) | (EIA-364-20C)<br>Mated connectors with 1000±5% VAC for 1 minute 0.5 mA between adjacent contacts or ground.<br>对组装好的独立端子或接地物之间施加交流1000VAC 0.5mA 电流1 分钟。          | One minute hold with no breakdown or flashover.<br>不能有如跳电、击穿、破裂损坏。      |
| 4.2.3 | Insulation Resistance<br>绝缘阻抗            | (EIA-364-21C)<br>Mated connectors with 500±10%VDC between adjacent contacts or ground.<br><br>对组装好的独立端子或接地物之间施以500±10%VDC的电压测试                                   | 500MΩ min (unmated)<br><br>没有配对需大于500 MΩ                                |

## 4.3 Mechanical Performance(机械性能)

|                               |                                       |   |   |
|-------------------------------|---------------------------------------|---|---|
| 4.3.1                         | Insertion/Withdrawal Force<br>插入力/拔出力 | (EIA-364-13)<br>Insertion and withdrawal speed: 25mm/minute.<br>插入和拔出的速度为25mm/分   | Maximum insertion force 22N<br>插入力不超过30N(3.0/kg)<br>Withdrawal force 22N max<br>拔出力不超过30N(3.0/kg)   |
| 4.3.2                         | Durability<br>寿命测试                    | (EIA-364-09)<br>Operation Speed:10 To 20cycle/min.<br>Durability cycles:750cycles<br>测试速度：每分钟10到20个循环，测试次数：750次循环最少   | Meet visual requirements,show no physical damage,and meet requirements of additional tests as specified in the product qualification<br><br>测试后满足外观要求，无变形损伤.  |
| 4.3.3                         | Vibration<br>振动                       | (EIA-364-28条件3)<br>Amplitude:1.52mm P-P or 147m/s <sup>2</sup> {15G}<br>Sweep time: 50-2000-50Hz in 20 minutes.<br>Duration: 12 times in each (total of 36 times) X, Y, Z, axes.<br>Electrical load DC 100mA current shall be flowed during the test.(ANSI/EIA-364-28 Condition III)<br>在直流100毫安通电状态下测试，在X,Y,Z垂直3方向上，频率50-2000-50赫兹（加速度往复20分钟），全振幅1.52mm P-P或147 m/s <sup>2</sup> {15G}，每轴12回计36回 | Appearance: No damage<br>外观：无损坏<br><br>Discontinuity: 1μ sec Max.<br>间断性：不超过1微秒   |
| 4.3.4                         | Physical shock<br>冲击性                 | (EIA-364-27条件A)<br>Pulse width: 11msec<br>Waveform: Half-sine<br>490m/s <sup>2</sup> (50G) 3 strokes in each X, Y, Z axes.<br>(ANSI/EIA-364-27 condition A)<br>周期：11msec<br>冲击波形：正弦半波490m/s <sup>2</sup> (50G) 3 循环在X, Y, Z 轴   | Appearance: No damage<br>外观：无损坏<br><br>Discontinuity: 1μ sec Max.<br>间断性：不超过1微秒   |
| 4.4 Environmental Performance |                                       |   |   |
| 4.4.1                         | Thermal shock test<br>冷热冲击            | EIA-364-32C条件1)<br>10 cycles of:<br>a)-55±3℃ for 30 minutes<br>b) +85±3℃ for 30 minutes<br>10个循环，<br>a)-55±3℃ 30 分钟<br>b) +85±3℃ 30 分钟  | Appearance: No Damage.<br>外观：没有损坏<br>Contact Resistance 接触阻抗<br>Contact: Change from initial Value 30mΩ Max<br>Shell Part: Change from initial Value 50mΩ Max<br>端子：从初始值开始变化量小于30mΩ<br>外壳：从初始值开始变化量小于50mΩ |

|        |                       |   |   |
|--------|-----------------------|---|---|
| 4.4..2 | Solder ability<br>焊锡性 | (EIA-364-52)<br>To be sipped in the solder bath 245±5°C<br>Coverage for 3 seconds.<br>将焊锡脚浸在245±5°C的锡炉中<3秒  | The inspected area of each lead must have 95% solder coverage minimum   |
| 4.4..3 | Humidity<br>恒温恒湿      | (EIA-364-31B)<br>(A) Mate connectors together and perform the test as follows<br>配对连接器测试条件<br>Temperature: +25°C to +85°C(温度: +25°C到+85°C)<br>Relative Humidity: 80% to 90%(相对湿度: 80%到90%)<br>Duration:4 cycles(96 hours) (持续时间: 4个循环共96小时)<br>Upon completion of the test, specimens shall be conditioned ambient room conditions for 24 hours, after which the specified measurements shall be performed.<br>试验完成后, 样品放置于室温条件中24小时后再进行测试  | Appearance: No Damage<br>外观, 没有损坏   |
| 4.4..4 | Salt Spray<br>盐水喷雾    | EIA-364-26B)<br>Tested as below:<br>Temperature:(35±2) °C<br>Humidity:(95-98)%(R.H.)<br>PH:6.5-7.2<br>It shall be subjected to stand ard atmospheric condition 1hours after removing the salt deposits.<br>It should meet the contact resistance.object non-contact area:<br>Temperature: (35±2) °C<br>Salt-solution(5±1)%<br>Duration time:12hours<br>测试条件如下:<br>温度:(35±2) °C<br>湿度:(95-98)%(R.H.)<br>PH值:6.5-7.2<br>物体在移出盐水槽后应置于标准大气条件中一个小时后再进行测量动作:<br>盐水密度: (5±1) %<br>持续时间: 24小时 | No detrimental corrosion( Terminal solder tail unrequested)<br>产品无氧化, 锈蚀 (端子焊脚镀锡处不作要求)<br><br>Does not include bending position; 不包含折弯处位置 |

|        |                                     |   |   |
|--------|-------------------------------------|---|---|
| 4.4..5 | Cold resistance<br>(Unmated)<br>冷阻抗 | (EIA-364-17B)<br>Unmated connectors and expose to $-40\pm 3^{\circ}\text{C}$ for 96 hours. Upon completion of the exposure period, the test specimens shall be conditioned at ambient room conditions for 1 to 2 hours, after which the specified measurements shall be performed.<br>没配对的连接器放置于 $-40\pm 3^{\circ}\text{C}$ 温度中96小时，当完成实验后，样品放置一般环境中1到2小时后，在进行测试                          | Appearance: No Damage.<br>外观：没有损坏   |
| 4.4..6 | Heat resistance<br>(Unmated)<br>热阻抗 | (EIA-364-17B)<br>Mated connectors and expose to $85\pm 2^{\circ}\text{C}$ for 96hours. Upon completion of the exposure period, the test specimens shall be conditioned at ambient room conditions for 1 to 2 hours, after which the specified measurements shall be performed.<br>配对的连接器放置于 $85\pm 2^{\circ}\text{C}$ 温度中96小时，当完成实验后，样品放置一般环境中1到2小时后，在进行测试                                | Appearance: No Damage.<br>外观：没有损坏   |
| 4.4..7 | Thermal Aging<br>高温老化               | (EIA-364-31B, Condition 4, Method A)<br>Unmated connectors and expose to $+105\pm 2^{\circ}\text{C}$ for 96 hours. Upon completion of the exposure period, the test specimens shall be conditioned at ambient room conditions for 1 to 2 hours, after which the specified measurements shall be performed.<br>没配对的连接器放置于 $+105\pm 2^{\circ}\text{C}$ 温度中96小时，当完成实验后，样品放置一般环境中1到2小时后，在进行测试 | Appearance: No Damage.<br>外观：没有损坏   |
| 4.4.8  | Resistance to Soldering Heat        | for wave soldering : mil-std-202f,method 210 A,test condition B<br>波峰焊: mil-std-202f, method 210 A, 试验条件B<br>Pre-heat : $80^{\circ}\text{C}$ , 60 Seconds 预热: $80^{\circ}\text{C}$ , 60秒<br>Temperature : $260 \pm 5^{\circ}\text{C}$ 温度: $260\pm 5^{\circ}\text{C}$<br>Immersion duration : $10 \pm 1$ sec. 浸泡时间: $10\pm 1$ 秒。   | No physical damage shall occur.<br>不可有损坏<br>Reflow welding is not applicable to PBT<br>回流焊不适用于PBT |



for manual soldering :手动焊接:  
 mil-std-202f,method 210 A,test condition A  
 Pre-heat : No预热:没有  
 Temperature : 350 ± 10 °C温度:350±10°C  
 Immersion duration :3.5±0.5 sec.浸泡时间:3.5±0.5秒

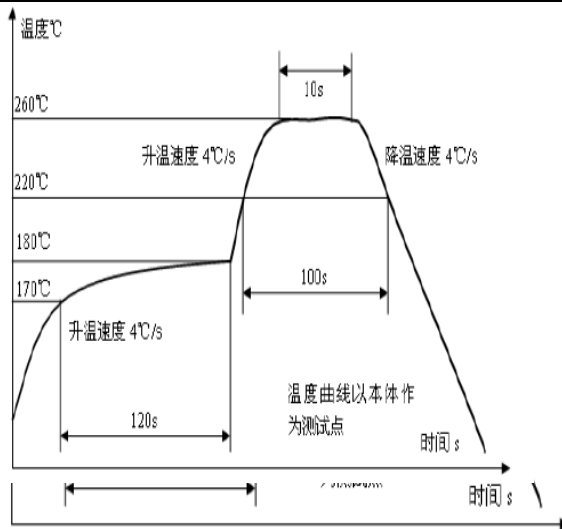

Note 1: Shall meet visual requirements, show no physical damage, and meet requirement of additional tests as specified in the test sequence in Figures 2

说明1: 测试要求不能有物理损坏, 测试依据表格二的顺序进行

3.Product Qualification And Requalification Test:产品测试顺序表 Figure 2

| Test or Examination                   | Test Group |     |     |   |     |     |     |     |     |     |     |     |     |   |
|---------------------------------------|------------|-----|-----|---|-----|-----|-----|-----|-----|-----|-----|-----|-----|---|
|                                       | A          | B   | C   | D | E   | F   | G   | H   | I   | J   | K   | L   | M   | N |
| Test Sequence                         |            |     |     |   |     |     |     |     |     |     |     |     |     |   |
| 4.1.1.Examination of Product 产品外观     | 1,9        | 1,3 | 1,5 | 1 | 1,5 | 1,5 | 1,5 | 1,3 | 1,5 | 1,5 | 1,5 | 1,5 | 1,5 | 1 |
| 4.2.1.Contact Resistance 接触阻抗         | 2,8        |     | 2,4 |   | 2,4 | 2,4 | 2,4 |     | 2,4 | 2,4 | 2,4 | 2,4 | 2,4 |   |
| 4.2.2.Dielectric Withstanding Voltage | 3,7        |     |     |   |     |     |     |     |     |     |     |     |     |   |
| 4.2.3.Insulation Resistance 绝缘阻抗      | 4,6        |     |     |   |     |     |     |     |     |     |     |     |     |   |
| 4.3.1.Insertion/Withdrawal force 插拔力  |            | 2   |     |   |     |     |     |     |     |     |     |     |     |   |

|                               |   |   |   |   |   |   |   |   |   |   |   |   |   |   |
|-------------------------------|---|---|---|---|---|---|---|---|---|---|---|---|---|---|
| 4.3.2.Durability 寿命测试         |   |   | 3 |   |   |   |   |   |   |   |   |   |   |   |
| 4.3.3.Vibration 振动性           |   |   |   | 3 |   |   |   |   |   |   |   |   |   |   |
| 4.3.4.Physical shock 冲击性      |   |   |   |   | 3 |   |   |   |   |   |   |   |   |   |
| 4.4.1.Thermal shock test 冷热冲击 |   |   |   |   |   | 3 |   |   |   |   |   |   |   |   |
| 4.4.2.Solderability 焊锡性       |   |   |   |   |   |   | 2 |   |   |   |   |   |   |   |
| 4.4.3.Humidity 恒温恒湿           | 5 |   |   |   |   |   |   | 3 |   |   |   |   |   |   |
| 4.4.4.Salt Spray 盐水喷雾         |   |   |   |   |   |   |   |   | 3 |   |   |   |   |   |
| 4.4.5.Cold resistance 冷阻抗     |   |   |   |   |   |   |   |   |   | 3 |   |   |   |   |
| 4.4.6.Heat resistance 热阻抗     |   |   |   |   |   |   |   |   |   |   | 3 |   |   |   |
| 4.4.7.Thermal Aging 高温老化      |   |   |   |   |   |   |   |   |   |   |   | 3 |   |   |
| 4.4.8.IR-reflow 回流焊测试         |   |   |   |   |   |   |   |   |   |   |   |   | 2 |   |
| NO. of Test samples(Min.) 测试样 | 5 | 5 | 5 | 5 | 5 | 5 | 5 | 5 | 5 | 5 | 5 | 5 | 5 | 5 |

NOTE 2: (a) Numbers indicate sequence in which tests are performed.

(b) Discontinuities shall not take place in this test group, during tests.

说明 2: (a)测试依照矩阵要求数量进行。

(b)在测试中，群组测试不能间断

核准：唐竹君

制作人：魏红

測試報告

TEST REPORT

|                   |                     |                         |                          |                               |                                   |
|-------------------|---------------------|-------------------------|--------------------------|-------------------------------|-----------------------------------|
| 產品名稱<br>Part Name | RJ11 6p6c 帶屏蔽无<br>彈 | 測試日期<br>Date of Testing | 2021.12.14<br>2021.12.15 | 報告編號<br>Report NO.            | MD20211215-01                     |
| 產品型號<br>Part Name | R11120-100G08       | 樣品數量<br>Quantity        | 5PCS                     | 測試環境<br>Measuring Environment | 濕度 Temp:18~21°C<br>相對濕度RH:49□~57□ |

一.電性測試 ELECTRICAL TEST

| 序號<br>NO. | 測試項目<br>Testing Item         | 測試條件<br>Testing Conditions  | 測試設備<br>Testing Equipment         | 規格<br>SPEC                         | 測試記錄Testing Result |             |             |             |             | 判定Judge |      |
|-----------|------------------------------|---|-----------------------------------|------------------------------------|--------------------|-------------|-------------|-------------|-------------|---------|------|
|           |                              |   |                                   |                                    | 1                  | 2           | 3           | 4           | 5           | Pass    | Fail |
| 1         | Contact resistance           | Test current:100mA<br>max   | DIGITAL MICRO-<br>OHMMETER        | 50mΩ<br>Max                        | 21.36<br>mΩ        | 20.05<br>mΩ | 18.62<br>mΩ | 20.55<br>mΩ | 21.53<br>mΩ | P       |      |
| 2         | Insulation resistance        | Test voltage:500VDC<br>Operation stated:1min                            | ULTRA HIGH<br>RESISTANCE<br>METER | 500MΩ<br>Min                       | Pass               | Pass        | Pass        | Pass        | Pass        | P       |      |
| 3         | Dielectric withstand voltage | Test voltage:1000VAC<br>Cut-off current:0.5mA<br>Operation stated:1 min | BREAKDOWN<br>TESTER               | No discharge or<br>flashover occur | Pass               | Pass        | Pass        | Pass        | Pass        | P       |      |

二.機械特性測試 MECHANICAL TEST

| 序號<br>NO. | 測試項目<br>Testing Item | 測試條件<br>Testing Conditions   | 測試設備<br>Testing Equipment          | 規格<br>SPEC            | 測試記錄Testing Result |      |      |      |      | 判定Judge |      |
|-----------|----------------------|--|------------------------------------|-----------------------|--------------------|------|------|------|------|---------|------|
|           |                      |  |                                    |                       | 1                  | 2    | 3    | 4    | 5    | Pass    | Fail |
| 1         | Durability test      | Rate:200cycles/hour<br>Total: 750 cycles                               | LIFE TESTER FOR<br>CONNECTOR       | No physical<br>damage | Pass               | Pass | Pass | Pass | Pass | P       |      |
| 2         | Mating Force         | 29.4Newtons maximum<br>at a maximum rare of<br>7.5mm(0.39") per minute | Insertion force<br>testing machine | 3.0kgf Max            | Pass               | Pass | Pass | Pass | Pass | P       |      |

三.環境特性測試 ENVIRONMENTAL TEST

| 序號<br>NO. | 測試項目<br>Testing Item       | 測試條件<br>Testing Conditions                               | 測試設備<br>Testing Equipment                  | 規格<br>SPEC         | 測試記錄 Testing Result |      |      |      |      | 判定 Judge |      |
|-----------|----------------------------|--|--|--------------------|---------------------|------|------|------|------|----------|------|
|           |                            |  |  |                    | 1                   | 2    | 3    | 4    | 5    | Pass     | Fail |
| 1         | Humidity-Temperature cycle | Temperature: 40±2°C<br>Humidity: 90~95%<br>Duration:168H | PROGRAM CONTROLLED TEMP. & HUMIDTY CHAMBER | No physical damage | Pass                | Pass | Pass | Pass | Pass | P        |      |
| 2         | Heat test                  | Temperature: 70±2°C<br>Duration:168H                     | OVEN                                       | No physical damage | Pass                | Pass | Pass | Pass | Pass | P        |      |
| 3         | Cold test                  | Temperature: -25±3°C<br>Duration:168H                    | PROGRAM CONTROLLED TEMP. & HUMIDTY CHAMBER | No physical damage | Pass                | Pass | Pass | Pass | Pass | P        |      |
| 4         | Temperature cycling test   | Temperature: -55~85°C<br>Duration:10 cycle               | PROGRAM CONTROLLED TEMP. & HUMIDTY CHAMBER | No physical damage | Pass                | Pass | Pass | Pass | Pass | P        |      |

#### 四.物理測試 PHYSICAL TEST

| 序號<br>NO. | 測試項目<br>Testing Item              | 測試條件<br>Testing Conditions  | 測試設備<br>Testing Equipment           | 規格<br>SPEC          | 測試記錄 Testing Result |      |      |      |      | 判定 Judge |      |
|-----------|-----------------------------------|---|-------------------------------------|---------------------|---------------------|------|------|------|------|----------|------|
|           |                                   |   |                                     |                     | 1                   | 2    | 3    | 4    | 5    | Pass     | Fail |
| 1         | Salt spray test                   | Temperature: 35±2°C<br>Concentration:5±1 %<br>Duration:12H                            | SALT SPRAY TESTER                   | No Oxidation        | Pass                | Pass | Pass | Pass | Pass | P        |      |
| 2         | Resistance to soldering heat test | Temperature: 245°C<br>Duration:3 sec  | OVEN                                | No physical damage  | Pass                | Pass | Pass | Pass | Pass | P        |      |
| 3         | Solder ability test               | Temperature: 245±5°C<br>Duration:5±0.5 sec  | CONTROLLED CONSTANT-TEMP SOLDER POT | Soldering area ≥95□ | Pass                | Pass | Pass | Pass | Pass | P        |      |
| 判定 Result |                                   | <input checked="" type="checkbox"/> 合格 (ACCEPT) <input type="checkbox"/> 不合格 (REJECT) |                                     |                     |                     |      |      |      |      |          |      |

核准(Approver): 欠必鋒

測試(Tester): 但芬



# 深圳市华联威电子科技有限公司

## 檢驗報告

首件檢驗
 入庫檢驗
 出貨檢驗
 客退檢驗
 退料檢驗
 其他
 2021年12月15日 版次:A1

| 料號  | R11120-100G08   | 制令單號  | /       |           | 送檢單位     | 工程部       | 首件製作者 | 裝配      |          |     |     |     |    |
|---|-----------------|---|---------|-----------|----------|-----------|-------|---------|----------|-----|-----|-----|----|
| 品名  | RJ11 6P6C 帶屏蔽无彈 | 客戶代號  | /       |           | 批 量      | /         | 送檢時間  | /       |          |     |     |     |    |
|   |                 |   |         |           | 數 量      | 5PCS      | 確認時間  | /       |          |     |     |     |    |
| 抽樣標準  |                 | <input checked="" type="checkbox"/> 單次 <input type="checkbox"/> 雙次  |         |           | 抽樣數      | AQL       | CRI:0 | MAJ:0.4 | MIN:0.65 |     |     |     |    |
| MIL-STD-105E(II)  |                 | <input checked="" type="checkbox"/> 正常 <input type="checkbox"/> 加嚴 <input type="checkbox"/> 減量  |         |           | ( 5PCS ) | ACC/REJ   | 0     | /       | /        |     |     |     |    |
| 不良數:  |                 | CRI ( / )   |         | MAJ ( / ) |          | MIN ( / ) |       | 不良率(%)  | /        |     |     |     |    |
| NO.   | 檢驗項目<br>單位:MM/G | 檢測<br>儀器  | 檢 驗 記 錄 |           |          |           |       | 品管判定    |          | CRI | MAJ | MIN | 備注 |
|   |                 |   | 1       | 2         | 3        | 4         | 5     | AC      | RE       |     |     |     |    |
| 尺<br>寸<br>測<br>量  | 12.9±0.30       | D   | 12.96   | 12.94     | 12.95    | 12.93     | 12.91 | √       |          |     |     |     |    |
|   | 9.50±0.20       | D   | 9.56    | 9.54      | 9.53     | 9.55      | 9.56  | √       |          |     |     |     |    |
|   | 12.30±0.20      | D   | 12.36   | 12.34     | 12.35    | 12.33     | 12.34 | √       |          |     |     |     |    |
|   | 12.5±0.30       | D   | 12.56   | 12.53     | 12.55    | 12.54     | 12.56 | √       |          |     |     |     |    |
|   | 17.0±0.30       | D   | 17.06   | 17.05     | 17.09    | 17.10     | 17.08 | √       |          |     |     |     |    |
|   | 12.9±0.30       | D   | 12.96   | 13.00     | 12.99    | 13.02     | 13.05 | √       |          |     |     |     |    |
|   | 12.75±0.20      | D   | 12.78   | 12.75     | 12.76    | 12.78     | 12.75 | √       |          |     |     |     |    |
|   | 1.20±0.20       | D   | 1.26    | 1.25      | 1.24     | 1.23      | 1.24  | √       |          |     |     |     |    |
|   | 7.8±0.30        | D   | 7.86    | 7.84      | 7.85     | 7.82      | 7.81  | √       |          |     |     |     |    |
|   | 5.10±0.20       | D   | 5.13    | 5.15      | 5.12     | 5.10      | 5.12  | √       |          |     |     |     |    |
|   | 3.2±0.30        | D   | 3.26    | 3.25      | 3.23     | 3.24      | 3.25  | √       |          |     |     |     |    |
|   |                 |   |         |           |          |           |       |         |          |     |     |     |    |
| 檢驗依據: <input checked="" type="checkbox"/> 《工程圖紙》 <input type="checkbox"/> 《檢驗規範》 <input type="checkbox"/> 《承認書》 <input type="checkbox"/> 樣品 <input type="checkbox"/> 其它 |                 |   |         |           |          |           |       |         |          |     |     |     |    |
| 檢測儀器:A游標卡尺 B千分尺 C厚薄儀 D投影鏡 E放大鏡 F顯微鏡 G錫爐 H插拔力器 I間位尺 J其它  |                 |   |         |           |          |           |       |         |          |     |     |     |    |
| 品保判定:   |                 | <input checked="" type="checkbox"/> 合格Accept <input type="checkbox"/> 退貨Reject <input type="checkbox"/> 特采Waive <input type="checkbox"/> 挑選Sort |         |           |          |           |       |         |          |     |     |     |    |

核准: 欠必鋒

審核: 刘联英

檢驗員: 但芬

## 电镀报告表

|                             |         |               |        |           |          |
|-----------------------------|---------|---------------|--------|-----------|----------|
| 品名:RJ11 6p6c (端子)           |         | 版次:A.0        |        |           |          |
| 电镀规格:Ni40u", Sn40u", Au 1u" |         | 日期:2021-09-10 | 页次:1/1 |           |          |
| 厂商:同华                       |         |               |        |           |          |
| 测试设备:CMI X-射线膜厚测试仪          |         |               |        |           |          |
| 1、底层电镀测试 (Ni)               |         |               |        |           |          |
| 数据                          | 测试标准    | 实测值           | 判定     | 测试日期      | 测试时间     |
| 1                           | 40u"MIN | 60.5u"        | OK     | 2021/9/10 | 14:15:03 |
| 2                           | 40u"MIN | 58.3u"        | OK     | 2021/9/10 | 14:15:05 |
| 3                           | 40u"MIN | 67.5u"        | OK     | 2021/9/10 | 14:15:07 |
| 4                           | 40u"MIN | 62.4u"        | OK     | 2021/9/10 | 14:15:09 |
| 2、表层电镀测试 (Sn)               |         |               |        |           |          |
| 数据                          | 测试标准    | 实测值           | 判定     | 测试日期      | 测试时间     |
| 1                           | 40u"MIN | 45.3u"        | OK     | 2021/9/10 | 14:20:12 |
| 2                           | 40u"MIN | 52.7u"        | OK     | 2021/9/10 | 14:20:14 |
| 3                           | 40u"MIN | 58.9u"        | OK     | 2021/9/10 | 14:20:16 |
| 4                           | 40u"MIN | 54.3u"        | OK     | 2021/9/10 | 14:20:18 |
| 3、表层电镀测试 (Au)               |         |               |        |           |          |
| 数据                          | 测试标准    | 实测值           | 判定     | 测试日期      | 测试时间     |
| 1                           | 1u"MIN  | 1.02u"        | OK     | 2021/9/10 | 14:25:06 |
| 2                           | 1u"MIN  | 1.08u"        | OK     | 2021/9/10 | 14:25:08 |
| 3                           | 1u"MIN  | 1.06u"        | OK     | 2021/9/10 | 14:25:10 |
| 4                           | 1u"MIN  | 1.05u"        | OK     | 2021/9/10 | 14:25:12 |

核准: 欠必锋

审核: 刘联英

检验员: 但芬

## 电镀报告表

| 品名:RJ11 6P6C (外壳)  |         | 版次:A.0       |    |           |          |    |      |     |    |      |      |   |         |        |    |           |          |   |         |        |    |           |          |   |         |        |    |           |          |   |         |        |    |           |          |
|--|---------|--------------|----|-----------|----------|----|------|-----|----|------|------|---|---------|--------|----|-----------|----------|---|---------|--------|----|-----------|----------|---|---------|--------|----|-----------|----------|---|---------|--------|----|-----------|----------|
| 电镀规格:Ni:50u" min   |         | 日期:2021-9-14 |    | 页次:1/1    |          |    |      |     |    |      |      |   |         |        |    |           |          |   |         |        |    |           |          |   |         |        |    |           |          |   |         |        |    |           |          |
| 厂商:金和源   |         |              |    |           |          |    |      |     |    |      |      |   |         |        |    |           |          |   |         |        |    |           |          |   |         |        |    |           |          |   |         |        |    |           |          |
| 测试设备:CMI X-射线膜厚测试仪   |         |              |    |           |          |    |      |     |    |      |      |   |         |        |    |           |          |   |         |        |    |           |          |   |         |        |    |           |          |   |         |        |    |           |          |
| 1、表层电镀测试 (Ni)  |         |              |    |           |          |    |      |     |    |      |      |   |         |        |    |           |          |   |         |        |    |           |          |   |         |        |    |           |          |   |         |        |    |           |          |
| <table border="1"><thead><tr><th>数据</th><th>测试标准</th><th>实测值</th><th>判定</th><th>测试日期</th><th>测试时间</th></tr></thead><tbody><tr><td>1</td><td>50u"min</td><td>55.3u"</td><td>OK</td><td>2021/9/14</td><td>10:42:14</td></tr><tr><td>2</td><td>50u"min</td><td>57.6u"</td><td>OK</td><td>2021/9/14</td><td>10:42:16</td></tr><tr><td>3</td><td>50u"min</td><td>56.4u"</td><td>OK</td><td>2021/9/14</td><td>10:42:18</td></tr><tr><td>4</td><td>50u"min</td><td>52.5u"</td><td>OK</td><td>2021/9/14</td><td>10:42:20</td></tr></tbody></table> |         |              |    |           |          | 数据 | 测试标准 | 实测值 | 判定 | 测试日期 | 测试时间 | 1 | 50u"min | 55.3u" | OK | 2021/9/14 | 10:42:14 | 2 | 50u"min | 57.6u" | OK | 2021/9/14 | 10:42:16 | 3 | 50u"min | 56.4u" | OK | 2021/9/14 | 10:42:18 | 4 | 50u"min | 52.5u" | OK | 2021/9/14 | 10:42:20 |
| 数据   | 测试标准    | 实测值          | 判定 | 测试日期      | 测试时间     |    |      |     |    |      |      |   |         |        |    |           |          |   |         |        |    |           |          |   |         |        |    |           |          |   |         |        |    |           |          |
| 1  | 50u"min | 55.3u"       | OK | 2021/9/14 | 10:42:14 |    |      |     |    |      |      |   |         |        |    |           |          |   |         |        |    |           |          |   |         |        |    |           |          |   |         |        |    |           |          |
| 2  | 50u"min | 57.6u"       | OK | 2021/9/14 | 10:42:16 |    |      |     |    |      |      |   |         |        |    |           |          |   |         |        |    |           |          |   |         |        |    |           |          |   |         |        |    |           |          |
| 3  | 50u"min | 56.4u"       | OK | 2021/9/14 | 10:42:18 |    |      |     |    |      |      |   |         |        |    |           |          |   |         |        |    |           |          |   |         |        |    |           |          |   |         |        |    |           |          |
| 4  | 50u"min | 52.5u"       | OK | 2021/9/14 | 10:42:20 |    |      |     |    |      |      |   |         |        |    |           |          |   |         |        |    |           |          |   |         |        |    |           |          |   |         |        |    |           |          |

核准: 欠必锋

审核: 刘联英

检验员: 但芬

## 盐水喷雾实验报告

|        |                                  |        |                      |
|--------|----------------------------------|--------|----------------------|
| 试验方法   | 盐水喷雾腐蚀试验法                        | 参考资料   | MIL-STD-1216         |
| METHOD | NEUTRL SALT SPRAY CORROSION TEST | REF    |                      |
| 客户     | /                                | 试验起始日期 | 2021年12月14日 20:00 时起 |
|        |                                  | DATE   | 2021年12月15日 08:00 时止 |
| 样品名称   | RJ11 6P6C 带屏蔽无弹                  | 试验数量   | 5PCS                 |
| P/N    | R11120-100G08                    |        |                      |

### 试验条件 (TEST CONDITION)

- 1、盐水溶解 (SALT SOLUTION: 浓度 $50 \pm 10\text{g/L}$ , PH值6.5-7.2).
- 2、试验室温度 (TEMP. IT THE SPRAY DHAMBR):  $35 \pm 1^\circ\text{C}$ .
- 3、盐水桶温度 (TEMP. OF SALE SOL' N TANK):  $35 \pm 1^\circ\text{C}$ .
- 4、压力桶温度 (TEMP. OF SAR SUPPLIERY):  $47 \pm 1^\circ\text{C}$ .
- 5、试验室相对湿度 (R. H IN THE CHAMBER ) 85%.
- 6、压缩空气压力 (COMPRESSED AIR PRESSURE):  $1.00 \pm 0.01\text{Kg/cm}^2$ .
- 7、样品放置位置 (SPECIMEN SUPPORTED ANGLE ): 尼龙绳吊挂 $70^\circ - 90^\circ$ .
- 8、喷雾收集量 (COLLECT RATE OF SALT SOL' N)  $1-2\text{mL}/(8 \text{ cm}^2\text{hr})$ .
- 9、盐雾测试时间: 12小时 (H)

### 判定方法 (ADFUSGD METHOD)

试验后以20倍放大镜观察、无蓝、绿色腐蚀物之现象 (不包含折弯处), 即判定合格. (Inspext the ecimen at 20 xmagnification no blue or green corrosion products are acceptable)

| 样品序号 | 试验后现象                 | 判定      |
|------|-----------------------|---------|
|      | PHENOMENON AFTER TEST | COMMENT |
| 1    | 无蓝、绿色腐蚀物之现象           | OK      |
| 2    | 无蓝、绿色腐蚀物之现象           | OK      |
| 3    | 无蓝、绿色腐蚀物之现象           | OK      |
| 4    | 无蓝、绿色腐蚀物之现象           | OK      |
| 5    | 无蓝、绿色腐蚀物之现象           | OK      |
|      |                       |         |
|      |                       |         |
|      |                       |         |

核准: 欠必锋

审核: 刘联英

试验员: 但芬



# 材 质 证 明

兹有我司邦奇塑料科技有限公司为贵司所提供的产品不防火增加级原料 PBT 不防火加纤 20%黑色，由以下物质组成：

物品名称：PBT 不防火加纤黑色 20%

|               |        |
|---------------|--------|
| 组成物质：PBT 环保树脂 | 60-70% |
| 玻纤            | 20-25% |
| 增韧剂           | 7-9%   |
| 润滑剂           | 0.1%   |
| 抗氧化剂          | 0.1%   |
| 偶联剂           | 0.5%   |
| 其它            | 0.3%   |
| 黑色母           | 1-2%   |

建议成型：

1. 烘干温度 120-140℃
2. 烘干时间 2-4 小时
3. 成型温度 240-260℃

特此证明！

东莞市邦奇塑料科技有限公司



# 鉅鼎銅材廠檢驗報告單

|                              |                          |                      |                                |                        |                                   |                             |                                      |                       |      |    |
|------------------------------|--------------------------|----------------------|--------------------------------|------------------------|-----------------------------------|-----------------------------|--------------------------------------|-----------------------|------|----|
| 公司名稱<br>Customer             | 鉅鼎銅材廠檢驗報告單               |                      |                                |                        | 重量<br>Weight(kg)                  | 1078                        | 出貨日期<br>Date                         | 2021/11/23            |      |    |
| 品名<br>Article                | 標準<br>Standard No        |                      |                                |                        | 尺寸<br>Dimension                   |                             | 狀態<br>Tenper                         | 銅卷編號<br>Coil No       |      |    |
| C2680                        | JISH3100:2017            |                      |                                |                        | 0.18*400                          |                             | EH                                   | 1021-C-08             |      |    |
| 化學成分Chemical Compositions(%) |                          |                      |                                |                        |                                   |                             |                                      |                       |      |    |
| 元素<br>Element                | Cu %                     | Zn%                  | Pb%                            | Fe%                    | \                                 | \                           | \                                    | \                     | 化學成分 | 雜質 |
| 規範<br>Spec                   | 64.0-68.0                | 餘量                   | <0.05                          | <0.05                  | \                                 | \                           | \                                    | \                     | 合格   | 合格 |
| 實測<br>Actual                 | 64.32                    | 餘量                   | 0.0036                         | 0.0136                 | \                                 | \                           | \                                    | \                     | 合格   | 合格 |
| 機械性質Mechanical Properties    |                          |                      |                                |                        |                                   |                             |                                      |                       |      |    |
| 項目<br>Item                   | 結晶粒度<br>Grain Size<br>Mm | 硬度<br>Hardness<br>Hv | 抗拉強度<br>TensionStrength<br>Mpa | 伸長度<br>Elongation<br>% | 導電率<br>Electrical Conduc<br>%IACS | 彎曲試驗<br>Bending Test<br>180 | 表面粗度<br>Surface Roughness<br>Ra(u m) | 彎曲度<br>Camber<br>mm/n |      |    |
| 規範MAX<br>Spec                | \                        | 170-190              | 490-610                        | \                      | \                                 | \                           | \                                    | \                     |      |    |
| 實測<br>Actual                 | \                        | 178                  | 574                            | 5                      | \                                 | \                           | \                                    | \                     |      |    |

品質部



东莞市金思拓金属有限公司  
产品质量证明书

产品批号

QR/ZHT-8.2.4-14

| 产品名称 |       | 牌号            | 规格     | 状态    | 厚度公差  |       | 宽度公差          |      |
|------|-------|---------------|--------|-------|-------|-------|---------------|------|
| 磷铜   |       | C5191         | 0.46   | H     | 0.01  |       | + 0/ - 0.01mm |      |
| 化学成份 | 锡sn   | 磷p            | 铝AL    | 锌Zn   | 镍Ni   | 铁Fe   | 铅Pb           | 铜Cu  |
|      | 5.704 | 0.149         | ≤0.002 | /     | 0.263 | ≤0.02 | ≤0.01         | 余量   |
| 物理性能 | 抗拉强度  | 伸长率           |        | 维氏硬度H |       | 数 量   |               |      |
|      | 715   | 8             |        | 222   |       | 1卷    |               | 15kg |
| 技术条件 | 符合    | GB/T2059-2000 |        | 标准    |       |       |               |      |
| 化学成份 | 符合    | GB/T5231-2001 |        |       |       |       |               |      |