

REV.	ECN.NO.	APPD.
A	/	/

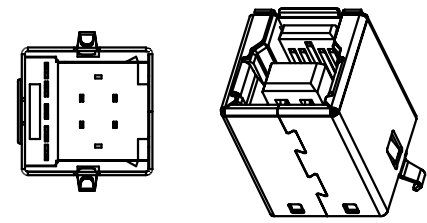
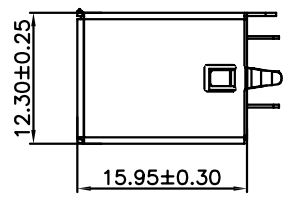
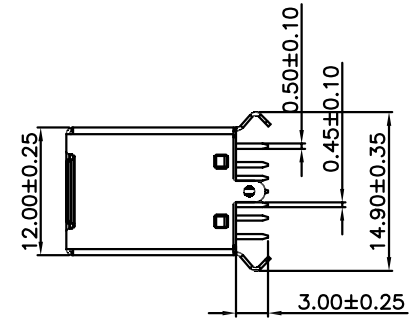
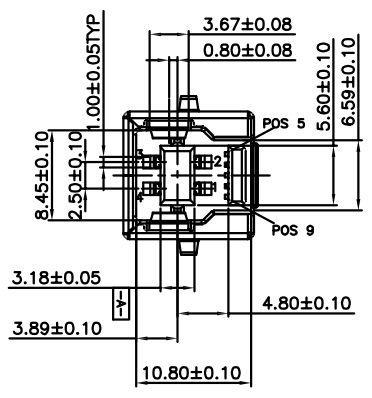
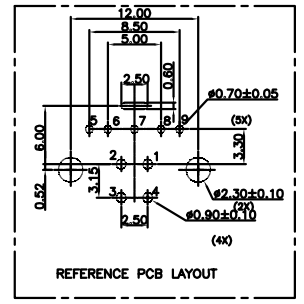
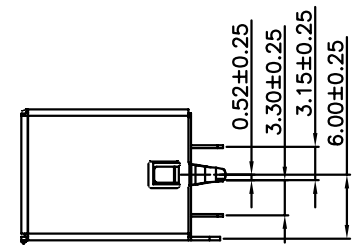
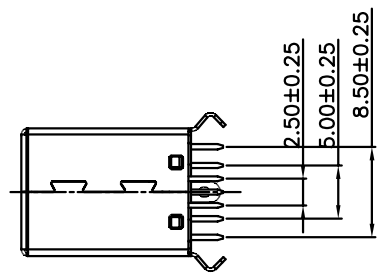

**SPECIFICATIONS:**  
**Contact current Rating:**  
 1.8 Amperes for pin1&pin4.  
 0.25 Amperes other contacts  
**Dielectric Withstanding Voltage:AC 100V(RMS)**  
**Insulation resistance:100Megohms Minimum.**  
**Contact Resistance:**  
 30mΩ Max for pin1&pin4  
 50mΩ Max for other contacts  
**Mechanical Characteristics:**  
**Mating Force:35 Newtons,Maximum**  
**Unmating Force:10 Newtons,Minimum.**  
**MATERIAL: SN Min After Durability**  
**Housing: PBT+30%GF 94V-0 COLOR:SEE TABLE**  
**Contact: copper alloy(T=0.25mm)**  
**Shell: SEE TABLE**  
**PLATING:**  
**Contact: Au Plated(SEE TABLE) on contact area**  
**Tin Plated on solder area**  
**Nickel underplating over all**  
**Shell: Nickel Plated**  
**operating Temperature:-55° to+85°**

U343-012X-XXX0X7

- 1:铁壳镀镍
- 5:铜壳镀镍
- 1:半金1u"
- 3:半金3u"
- 5:半金5u"
- 8:半金15u"
- 9:镀全金1u"
- G:半金G/Fu"
- 1:吸塑盒
- 2:吸塑管
- 3:载带
- 6:载带+贴麦拉
- 1:PA66
- 2:PBT
- 6:LCP
- 1:黑色
- 2:白色
- 3:米黄色
- 7:蓝色

TOLERANCE UNLESS OTHERWISE SPECIFIED		<b>FLW</b> 深圳市华联威电子科技有限公司				
.XXX ±0.10		HUA LIAN WEI TECHNOLOGY ELECTRONICS CO;LTD.				
.XX ±0.20		.X' ±3'				
.X ±0.30		.XX' ±2'				
APPROVED		PART NAME:	USB 3.0 BF 180度			
CHECKED		PART No:	U343-0125-G27017			C
DRAWN	weihong	PROJECTION:	UNIT:	SCALE	SHEET	REV.
DATE	2021.11.06		mm	1:1	10F1	A