

承 认 书

Approval Sheet

客户 (Customer): /

客户料号 (Cus .P/N): /

华联威料号 (HLW P/N):U212-0611-G63018

品名规格 (PronameSpec): USB AM SMT 180 度

送样日期 (Delivery Date):2022/04/29

承认日期 (Acknowledge Date): 2022/04/30

Approved No:		客 户 Customer	
采 购 部 Purchasing Dept	品 质 部 QC Dept	工 程 部 Engineering Dept	确 认 Approved By
深 圳 市 华 联 威 电 子 科 技 有 限 公 司 SHEN ZHEN SHI HUA LIAN WEI ELECTRONICS TECHNOLOGY CO; LTD.			
业 务 部 Sales Dept	品 管 部 QC Dept	工 程 部 Engineering Dept	核 准 Checked By
陈虹熹	欠必锋	魏红	唐竹君

地址:深圳市龙华区观澜街道桂香社区观澜桂花路 307 号

TEL: 0755-28888886 28888866

邮箱: hua@hlwconn.com

[Http://www.hlwconn.com](http://www.hlwconn.com)

目 录

Contents

图纸.....	Page03-04
产品规格书.....	Page05-11
产品检测报告.....	Page12-13
尺寸测试报告.....	Page14
电镀报告.....	Page15-16
盐雾报告.....	Page17
材质证明.....	Page18-20
SGS.....	Page21-58

REV.	ECN.NO.	APPD.
A	/	Qinyuhua

规格型号: Specifications:

电气特性: Electrical:

1. 额定电流: Current Rating
1.5A/contact terminal
2. 额定电压: Voltage Rating
30V DC
3. 接触阻抗: Contact Resistance
30 milliohms MAX
4. 耐电压: Dielectric Withstanding Voltage:
500 V AC AT Sea Level
5. 阻抗: Insulation Resistance:
1000MEGA ohms MIN

物理性能: Mechanical:

1. 插拔力: Connector Mate and Unmate Force
Mate force: 3.57kgf(MAX)
Unmate force: 1.02kgf(MIN)
2. 端子保持力: Terminal Retention
1.0kgf(MIN)

原材料: Material:

1. 塑膠: Housing:
Hing Temperature Ternmaplastics,
PBT\LCP White/Black
2. 端子: Contact: Copper Alloy C2680
3. 外壳: Shell: Copper Alloy C2680/SPCC

1. 端子: Contact: Plated Gold in Mating Area;
Tin On Solder Talls

端子四角鍍50U"(MIN)鍍

2. 外壳: Shell:

鍍鍍四角鍍80U"(MIN)鍍

Nickel Plating

U212-061X-X63018

- 1: Iron alloy
- Ni plating
- 5: Copper alloy
- Ni plating
- 1: Au 1u"
- 3: Au 3u"
- 5: Au 5u"
- 7: Au 10u"
- 8: Au 15u"
- A: Au 30u"
- G: Au G/Fu"
- 1: tray
- 2: Tube
- 8: Tape&Reel
- 9: Tape&Reel+Mylar
- 1: Black
- 2: White
- 3: Beige
- N: Pure White
- 1: PA66
- 2: PBT
- 6: LCP

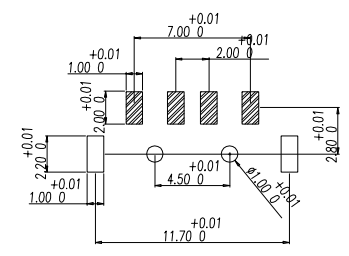
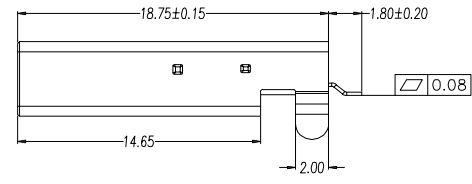
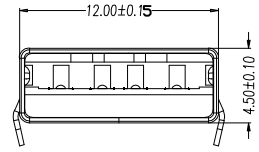
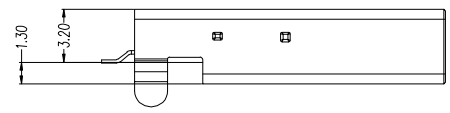
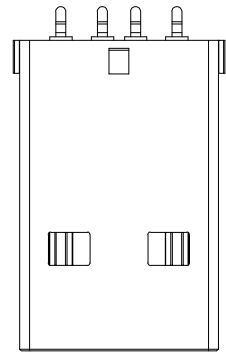
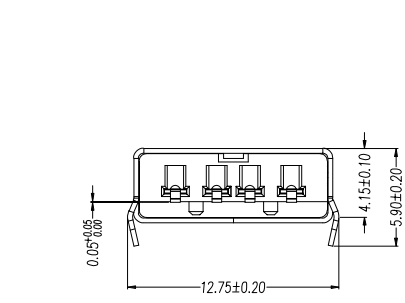

RECOMMENDED P.C.B LAYOUT

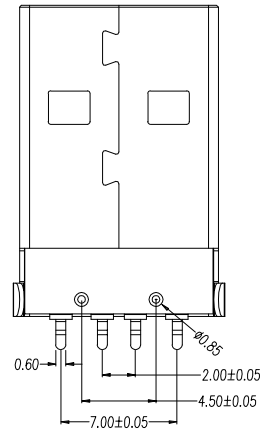

TOLERANCE UNLESS OTHERWISE SPECIFIED	
.XXX ±0.10	.X ±3°
.XX ±0.20	.XX ±2°
.X ±0.30	

FLW 深圳市华联威电子科技有限公司
HUA LIAN WEI TECHNOLOGY ELECTRONICS CO;LTD.

APPROVED		PART NAME:	USB AM SMT 180度			
CHECKED		PART No:	U212-0611-G63018			C
DRAWN	Qinyuhua	PROJECTION:	UNIT:	SCALE:	SHEET:	REV.
DATE	2021.12.08		mm	1:1	10F1	A

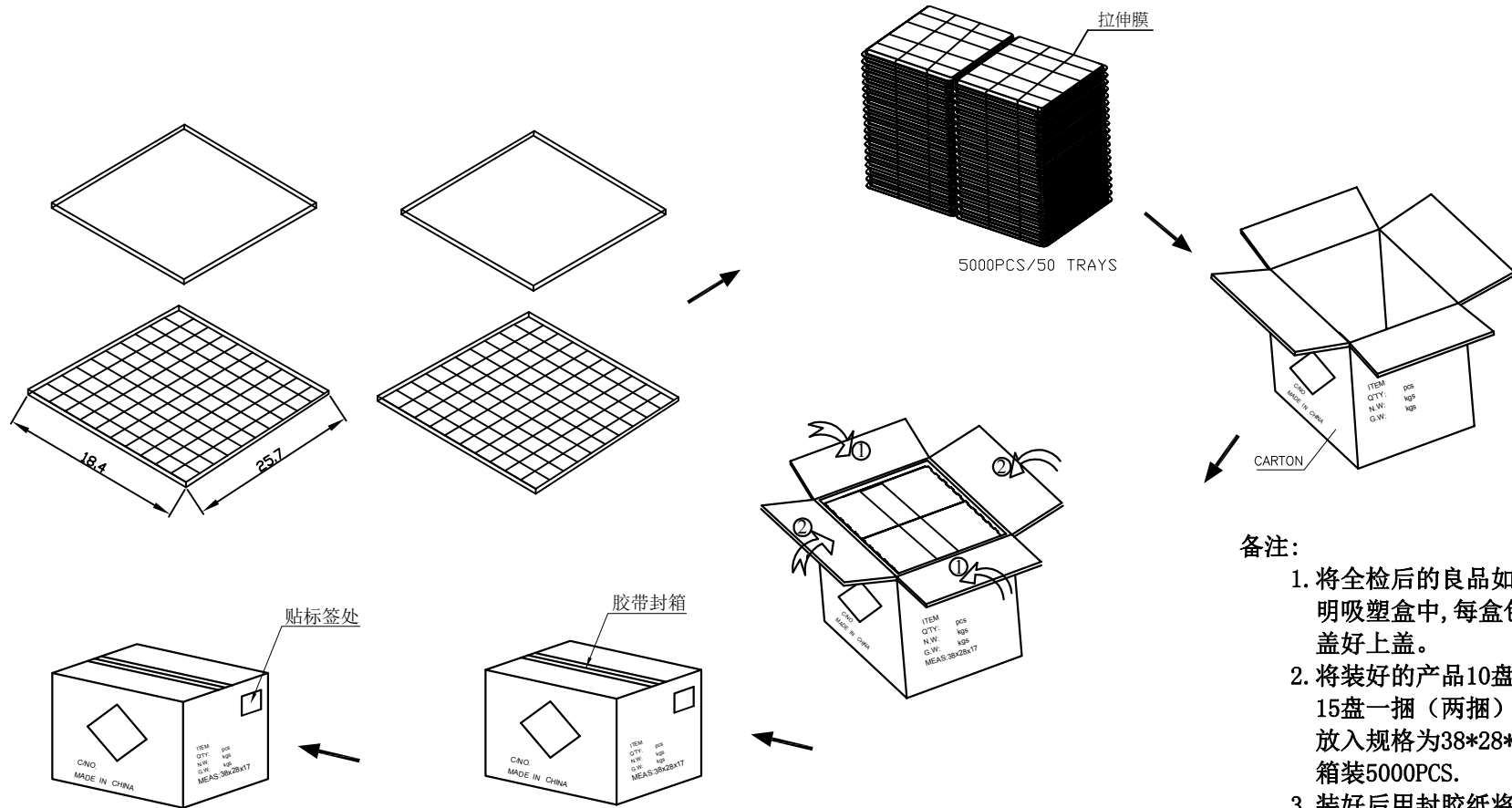

备注:

1. 将全检后的良品如图示摆入的PVC透明吸塑盒中, 每盒包装100PCS, 摆好后, 盖好上盖。
2. 将装好的产品10盘一捆(两捆) 15盘一捆(两捆), 打四个订, 放入规格为38*28*17cm的纸箱, 每箱装5000PCS.
3. 装好后用封胶纸将纸箱封好, 并在纸箱右上角标签框贴上外箱产品标签并盖上合格章. 在标签下面贴上RoHS标签,
4. 月份标签按月份标签粘贴作业规范进行

TOLERANCE UNLESS OTHERWISE SPECIFIED
.XX ±0.15
.X ±0.30
X. ±0.50
.X' ±3'

产品名称 PART NAME:	USB 2.0 AM 180度	
	料号	U212-0611-G63018
图号	B-1066	
	HLW 深圳市华联威电子科技有限公司 HUA LIAN WEI TECHNOLOGY ELECTRONICS CO;LTD.	

REV:	DESCRIPTION	REV BY	APPROVED	DATE	MATL:	SEE SPECIFICATION	APPROVED
A					PROJECTION:	THIRD ANGLE PROJECTION	CHECKED
					UNIT:	SCALE	REV(NO)
A	NEW DOWN	A	qinyuhua	2021.12.08	mm	1:1	A
						SHEET	DRAWN
						1 OF 1	DATE
							2021. 12. 08

USB2.0系列产品SPEC

版本版次: C

制定日期 20200707

适用范围 通用

1. Scope (范围)

1.1 Contents(内容)

This specification covers the performance, tests and quality requirements for the Electronics USB2.0 Connector.

(此份产品规格适用于USB2.0连接器的产品功能, 测试方法及质量要求)

2. Requirements (要求):

2.1 Rating(额定条件)

A. Voltage rating(额定电压):30V AC

B. Current rating(额定电流):1.5A

C. Operation Temperature Range(操作温度范围):0°C to +50°C

3. Test Condition(测试条件):

3.1 Temperature range(温度范围):-+15°C to +35°C

3.2 Humidity range (湿度范围):25% to 85%

4. Test Methods and Requirements:(测试方法及要求)

4.1 Examination of product (产品外观)

4.1.1	Examination of Product 产品外观	Visual 目视	No peeling off the plating deformation of the base or damage. 不得有电镀层剥落, 塑料变形或破损
-------	--------------------------------	--------------	--

4.2. Electrical Performance(电气性能)

4.2.1	Contact Resistance 接触阻抗	(EIA-364-06B) Mated connectors, Contact: measure by dry circuit, 30 m Volts maximum,20 mA 配对的连接器, 端子: 测试端子在回路中施加直流最大30mV 20mA的电流再测端子的电阻值	Initial Contact resistance Excluding conductor Resistance:30 mΩ max (Target design value) 接触电阻初始值最大不能超过30 mΩ (目标设计值)
-------	----------------------------	--	---

4.2.2	Dielectric Withstanding Voltage (耐电压)	<p>(EIA-364-20C)</p> <p>Unmated connectors, apply 500V AC (RMS.) for 1 minute between adjacent terminals of ground.</p> <p>没有配对的连接器在相邻的端子或接地之间通上500V的交流电压1分钟</p>	<p>1. No Breakdown or flashover 2. Leakage current:0.5mA Max</p> <p>1. 不能有损坏或跳火花 2. 漏电流<0.5mA</p>
4.2.3	Insulation Resistance 绝缘阻抗	<p>(EIA-364-21C)</p> <p>Unmated connectors, apply 500V DC for 1 minute between adjacent terminals of ground.</p> <p>没有配对的连接器在相邻的端子或接地之间通上500V的直流电压1分钟</p>	<p>1000MΩ min (unmated)</p> <p>没有配对需大于1000 MΩ</p>
4.3 Mechanical Performance(机械性能)			
4.3.1	Insertion/Withdrawal Force 插入力/拔出力	<p>(EIA-364-13)</p> <p>Insertion and withdrawal speed: 25mm/minute.</p> <p>插入和拔出的速度为25mm/分</p>	<p>Maximum insertion force 35N 插入力不超过35N(3.57kg) Withdrawal force 9.8N min 10N max 拔出力最小10N (1.02kg)</p>
4.3.2	Durability 寿命测试	<p>(EIA-364-09)</p> <p>Measure contact and shell resistance after the Following.</p> <p>Automatic cycling:1500 cycles at 100±5 Cycles per hour.</p> <p>以每小时100±5插拔次数测试1500循环后测量端子的接触阻抗</p>	<p>Contact Resistance 接触阻抗 Contact: Change from initial Value: 30 milliohms maximum. 端子: 从初始值开始变化量小于30mΩ Maximum insertion force 35N 插入力不超过35N(3.57kg) Withdrawal force 9.8N min 8N max 拔出力最小8N (1.02kg)</p>
4.3.3	Vibration 振动	<p>(EIA-364-28条件3)</p> <p>Amplitude:1.52mm P-P or 147m/s² {15G} Sweep time: 50-2000-50Hz in 20 minutes. Duration: 12 times in each (total of 36 times) X, Y, Z, axes. Electrical load DC 100mA current shall be flowed during the test.(ANSI/EIA-364-28 Condition III) 在直流100毫安通电状态下测试, 在X,Y,Z垂直3方向上, 频率50-2000-50赫兹(加速度往复20分钟), 全振幅1.52mm P-P或147 m/s² {15G}, 每轴12回计36回</p>	<p>Appearance: No damage 外观: 无损坏 Contact Resistance 接触阻抗 Contact: Change from initial Value:30mΩ Max. 端子: 从初始值开始变化量小于30mΩ Shell Part: Change from initial Value:50mΩ Max. 间断性: 不超过1微秒</p>

4.3.4	Physical shock 冲击性	<p>(EIA-364-27条件A)</p> <p>Pulse width: 11msec</p> <p>Waveform: Half-sine</p> <p>490m/s² (50G) 3 strokes in each X, Y, Z axes.</p> <p>(ANSI/EIA-364-27 condition A)</p> <p>周期: 11msec</p> <p>冲击波形: 正弦半波490m/s² (50G) 3 循环在X, Y, Z 轴</p>	<p>Appearance: No damage</p> <p>外观: 无损坏</p> <p>Contact Resistance 接触阻抗</p> <p>Contact: Change from initial Value 30mΩ Max</p> <p>端子: 从初始值开始变化量小于30mΩ</p> <p>Discontinuity: 1μ sec Max.</p> <p>间断性: 不超过1微秒</p>
4.4 Environmental Performance			
4.4.1	Thermal shock test 冷热冲击	<p>EIA-364-32C条件1)</p> <p>10 cycles of:</p> <p>a)-55±3°C for 30 minutes</p> <p>b) +85±3°C for 30 minutes</p> <p>10个循环,</p> <p>a)-55±3°C 30 分钟</p> <p>b) +85±3°C 30 分钟</p>	<p>Appearance: No Damage.</p> <p>外观: 没有损坏</p> <p>Contact Resistance 接触阻抗</p> <p>Contact: Change from initial Value 30mΩ Max</p> <p>端子: 从初始值开始变化量小于30mΩ</p>
4.4.2	Solder ability 焊锡性	<p>(EIA-364-52)</p> <p>To be sipped in the solder bath 245±5°C</p> <p>Coverage for 3 seconds.</p> <p>将焊锡脚浸在260±5°C的锡炉中<3秒</p>	<p>The inspected area of each lead must have 90% solder coverage minimum</p>
4.4.3	Humidity 恒温恒湿	<p>(EIA-364-31B)</p> <p>(A) Mate connectors together and perform the test as follows</p> <p>配对的连接器测试条件</p> <p>Temperature: +25°C to +85°C(温度: +25°C到+85°C)</p> <p>Relative Humidity: 90% to 95%(相对湿度: 90%到95%)</p> <p>Duration:4 cycles(96 hours) (持续时间: 4个循环共96小时)</p> <p>Upon completion of the test, specimens shall be conditioned ambient room conditions for 24 hours, after which the specified measurements shall be performed.</p> <p>试验完成后, 样品放置于室温条件中24小时后再进行测试</p>	<p>Appearance: No Damage</p> <p>外观, 没有损坏</p> <p>Contact Resistance 接触阻抗</p> <p>Contact: Change from initial Value 30mΩ Max</p> <p>端子: 从初始值开始变化量小于30mΩ</p>

		<p>(EIA-364-31B)</p> <p>(B) Unmated each connector and perform the test as follows. 没有配对的连接器测试条件 Temperature: +25°C to +85°C(温度: +25°C到+85°C) Relative Humidity: 90% to 95%(相对湿度: 90%到95%) Duration:4 cycles(96 hours) (持续时间: 4个循环共96小时)</p> <p>Upon completion of the test, specimens shall be conditioned ambient room conditions for 24 hours, after which the specified measurements shall be performed. 试验完成后, 样品放置于室温条件中24小时后再进行测试</p>	<p>Appearance: No Damage 外观, 没有损坏</p> <p>Conform to item of dielectric withstanding Voltage and Insulation Resistance. 符合耐电压及绝缘阻抗要求</p>
4.4..4	Salt Spray 盐水喷雾	<p>EIA-364-26B)</p> <p>Temperature: 35±2°C 温度: 35±2°C Concentration for salt: 50g±10g/1L 盐水浓度: 50±10g/L (1)Duration: 12H 持续时间: 12小时 Condition(条件): Contact plated gold more than 15u" (include 15 u"),and the material of shell for copper alloy, or stainless. 端子镀金厚度大于等于15 u" 且壳体材质是铜合金或是不锈钢 (2) Duration: 12H 持续时间: 12小时 Condition(条件): Contact plated gold less than 15 u" ,and/or the material of shell for steel 端子镀金厚度小于15u" 且/或壳体材质是铁材</p>	<p>No detrimental corrosion(Terminal solder tail unrequested) 产品无氧化, 锈蚀 (端子焊脚镀锡处不作要求)</p> <p>Contact Resistance 接触阻抗 Contact: Change from initial Value 30mΩ Max Shell Part: Change from initial Value 50mΩ Max 端子: 从初始值开始变化量小于30mΩ 外壳: 从初始值开始变化量小于50mΩ</p>
4.4..5	Cold resistance (Unmated) 冷阻抗	<p>(EIA-364-17B)</p> <p>Unmated connectors and expose to -25±3°C for 250 hours. Upon completion of the exposure period, the test specimens shall be conditioned at ambient room conditions for 1 to 2 hours, after which the specified measurements shall be performed. 没配对的连接器放置于-25±3°C温度中250小时, 当完成实验后, 样品放置一般环境中1到2小时后, 在进行测试</p>	<p>Appearance: No Damage. 外观: 没有损坏</p> <p>Contact Resistance 接触阻抗 Contact: Change from initial Value 30mΩ Max Shell Part: Change from initial Value 50mΩ Max 端子: 从初始值开始变化量小于30mΩ 外壳: 从初始值开始变化量小于50mΩ</p>

4.4..6	Heat resistance (Unmated) 热阻抗	<p>(EIA-364-17B)</p> <p>Mated connectors and expose to 85±2°C for 250 hours. Upon completion of the exposure period, the test specimens shall be conditioned at ambient room conditions for 1 to 2 hours, after which the specified measurements shall be performed.</p> <p>配对的连接器放置于85±2°C温度中250小时，当完成实验后，样品放置一般环境中1到2小时后，在进行测试</p>	<p>Appearance: No Damage. 外观：没有损坏</p> <p>Contact Resistance 接触阻抗 Contact: Change from initial Value 30mΩ Max Shell Part: Change from initial Value 50mΩ Max 端子：从初始值开始变化量小于30mΩ 外壳：从初始值开始变化量小于50mΩ</p>
4.4..7	Thermal Aging 高温老化	<p>(EIA-364-31B, Condition 4, Method A)</p> <p>Unmated connectors and expose to +85±2°C for 250 hours. Upon completion of the exposure period, the test specimens shall be conditioned at ambient room conditions for 1 to 2 hours, after which the specified measurements shall be performed.</p> <p>没配对的连接器放置于+85±2°C温度中250小时，当完成实验后，样品放置一般环境中1到2小时后，在进行测试</p>	<p>Appearance: No Damage. 外观：没有损坏</p> <p>Contact Resistance 接触阻抗 Contact: Change from initial Value 30mΩ Max Shell Part: Change from initial Value 50mΩ Max 端子：从初始值开始变化量小于30mΩ 外壳：从初始值开始变化量小于50mΩ</p>
4.4.8	Resistance to Soldering Heat	<p>for wave soldering : mil-std-202f,method 210 A,test condition B 波峰焊：mil-std-202f, method 210 A, 试验条件B</p> <p>Pre-heat : 80°C, 60 Seconds 预热:80°C, 60秒 Temperature : 260 ± 5 °C 温度:260±5°C Immersion duration : 10 ± 1 sec. 浸泡时间:10±1秒。</p>	<p>No physical damage shall occur. 不可有损坏</p>

for manual soldering :手动焊接:
 mil-std-202f,method 210 A,test condition A
 Pre-heat : No预热:没有
 Temperature : 350 ± 10 °C温度:350±10°C
 Immersion duration :3.5±0.5 sec.浸泡时间:3.5±0.5秒

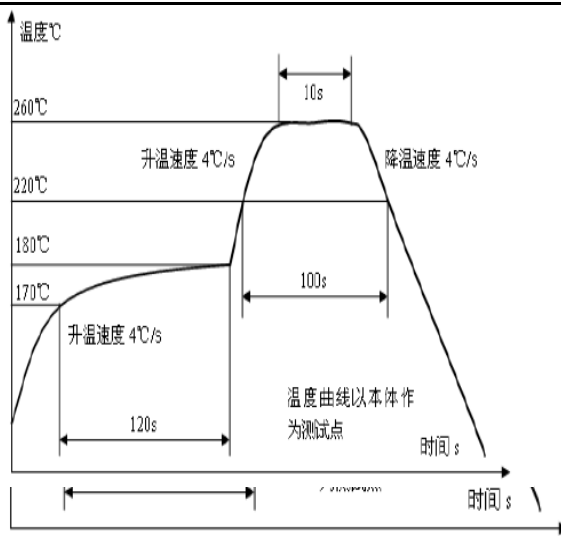

Note 1: Shall meet visual requirements, show no physical damage, and meet requirement of additional tests as specified in the test sequence in Figures 2

说明1: 测试要求不能有物理损坏, 测试依据表格二的顺序进行

3.Product Qualification And Requalification Test:产品测试顺序表 Figure 2

Test or Examination	Test Group													
	A	B	C	D	E	F	G	H	I	J	K	L	M	N
Test Sequence														
4.1.1.Examination of Product 产品外观	1,9	1,3	1,5	1	1,5	1,5	1,5	1,3	1,5	1,5	1,5	1,5	1,5	1
4.2.1.Contact Resistance 接触阻抗	2,8		2,4		2,4	2,4	2,4		2,4	2,4	2,4	2,4	2,4	

4.2.2.Dielectric Withstanding Voltage	3,7													
4.2.3.Insulation Resistance 绝缘阻抗	4,6													
4.3.1.Insertion/Withdrawal force 插拔力	2													
4.3.2.Durability 寿命测试		3												
4.3.3.Vibration 振动性			3											
4.3.4.Physical shock 冲击性				3										
4.4.1.Thermal shock test 冷热冲击					3									
4.4.2.Solderability 焊锡性						2								
4.4.3.Humidity 恒温恒湿	5						3							
4.4.4.Salt Spray 盐水喷雾								3						
4.4.5.Cold resistance 冷阻抗									3					
4.4.6.Heat resistance 热阻抗										3				
4.4.7.Thermal Aging 高温老化												3		
4.4.8.IR-reflow 回流焊测试														2
NO. of Test samples(Min.) 测试样	5	5	5	5	5	5	5	5	5	5	5	5	5	5

NOTE 2: (a) Numbers indicate sequence in which tests are performed.

(b) Discontinuities shall not take place in this test group, during tests.

说明 2: (a)测试依照矩阵要求数量进行。

(b)在测试中，群组测试不能间断

核准：唐竹君

制作人：魏红

深圳市华联威电子科技有限公司
 SHENZHENHUALIANWEIELECTRONICS CO., LTD.
 測試報告

TEST REPORT

品名稱 Part Name	USB AM SMT 180 度	測試日期 Date of Testing	2022-04.28 2022-04.29	報告編號 Report NO.	MD20220429-01
產品型號 Part Name	U212-0611-G63018	樣品數量 Quan tity	5PCS	測試環境 Measuring Environment	濕度 Temp:18~21°C 相對 濕度 R.H.:49%~57%

一. 電性測試 ELECTRICAL TEST

序號 NO.	測試項目 Testing Item	測試條件 Testing Conditions	測試設備 Testing Equipment	規格 SPEC	測試記 UTesting Result					判定 Judge	
					1	2	3	4	5	Pass	Fail
1	Contact resis tance	Test current:100mA max	DIGITAL MICROOHMMETER	30m Ω Max	18.36 m Ω	17.55 m Ω	18.29 m Ω	16.72 m Ω	16.18 m Ω	P	
2	Insula tion resis tance	Test voltage:500VDC Operation stated:1min	ULTRA HIGH RESISTANCE METER	1000 m Ω Min	Pass	Pass	Pass	Pass	Pass	P	
3	Dielec tric withstand voltage	Test voltage:500VAC Cut-off current:0.5mA Operation stated:1 min	BREAKDOWN TESTER	No discharge or flashover occur	Pass	Pass	Pass	Pass	Pass	P	

二. 機械特性測試 MECHANICAL TEST

序號 NO.	測試項目 Testing Item	測試條件 Testing Conditions	測試設備 Testing Equipment	規格 SPEC	測試記 UTesting Result					判定 Judge	
					1	2	3	4	5	Pass	Fail
1	Durability test	Rat e:200cycles/hour Total: 1500cycles	LIFE TESTER FOR CONNECTOR	No physical damage	Pass	Pass	Pass	Pass	Pass	P	
2	Mating Force	35 Newtons maximum at a maximum rare of 12.5mm(0.492") per minute	Insertion force testing machine	No physical damage	Pass	Pass	Pass	Pass	Pass	P	
3	Un-Mating Force	10 Newtons minimum at a maximum rare of 12.5mm(0.492") per minute	Insertion force testing machine	No physical damage	Pass	Pass	Pass	Pass	Pass	P	

三. 環境特性測試 ENVIRONMENTAL TEST

序號 NO.	測試項目 Testing Item	測試條件 Testing Conditions	測試設備 Testing Equipment	規格 SPEC	測試記 UTesting Result					判定 Judge	
					1	2	3	4	5	Pass	Fail

1	Humidity-Temperature cycle	Temperature: -30°C to 75°C Humidity: 90-95% Duration: 168H	PROGRAM CONTROLLED TEMP. & HUMIDITY CHAMBER	No physical damage	Pass	Pass	Pass	Pass	Pass	P
2	Heat test	Temperature: -40°C to 85°C Duration: 168H	OVEN	No physical damage	Pass	Pass	Pass	Pass	Pass	P
3	Cold test	Temperature: -25±3°C Duration: 168H	PROGRAM CONTROLLED TEMP. & HUMIDITY CHAMBER	No physical damage	Pass	Pass	Pass	Pass	Pass	P
4	Temperature cycling test	Temperature: 70—25°C Duration: 5 cycle	PROGRAM CONTROLLED TEMP. & HUMIDITY CHAMBER	No physical damage	Pass	Pass	Pass	Pass	Pass	P

四. 物理測試 PHYSICAL TEST

序號 NO.	測試項目 Testing Item	測試條件 Testing Conditions	測試設備 Testing Equipment	規格 SPEC	測試記錄 Testing Result					判定 Judge	
					1	2	3	4	5	Pass	Fail
1	Salt spray test	Temperature: 35±2°C Concentration: 5 ±1 % Duration: 12H	SALT SPRAY TESTER	No Oxidation	Pass	Pass	Pass	Pass	Pass	P	
2	Resistance to soldering heat test	Temperature: 260±5°C Duration: 10 ±1 sec	OVEN	No physical damage	Pass	Pass	Pass	Pass	Pass	P	
3	Solder ability test	Temperature: 260±5°C Duration: 10 ±1 sec	CONTROLLED CONSTANT-TEMP SOLDER POT	Soldering area 295%	Pass	Pass	Pass	Pass	Pass	P	
判定 Result		<input checked="" type="checkbox"/> 合格 (ACCEPT) <input type="checkbox"/> 不合格 (REJECT)									

核准 (Approver): 欠必鋒

測試 (Tester): 但芬

深圳市华联威电子科技有限公司

检验報告

首件檢驗
 入庫檢驗
 出貨檢驗
 客退檢驗
 退料檢驗
 其他
 2022年04月29日 版次:A1

料號	U212-0611-G63018	制令單號	/	送檢單位	工程部	首件製作者	裝配
品名	USB AM SMT 180度	客戶代號	/	批 量	/	送檢時間	/
				數 量	5PCS	確認時間	/

抽樣標準	<input checked="" type="checkbox"/> 單次 <input type="checkbox"/> 雙次	抽樣數	AQL	CRI:0	MAJ:0.4	MIN:0.6
MIL-STD-105E(II)	<input checked="" type="checkbox"/> 正常 <input type="checkbox"/> 加嚴 <input type="checkbox"/> 減量	(5PCS)	ACC/RE	0	/	/

不良數: CRI (/) MAJ (/) MIN (/) 不良率(%) /

NO.	檢驗項目 單位:MM/G	檢測 儀器	檢 驗 記 錄					品管判定		CRI	MAJ	MIN	備注
			1	2	3	4	5	AC	RE				
	5.90±0.20	D	5.95	5.93	5.92	5.95	5.92	√					
尺 寸 測 量	12.75±0.20	D	12.76	12.76	12.74	12.75	12.73	√					
	3.20±0.20	D	3.25	3.22	3.23	3.24	3.26	√					
	12.00±0.15	D	12.05	12.04	12.02	12.03	12.05	√					
	4.50±0.10	D	4.56	4.54	4.55	4.56	4.54	√					
	7.00±0.05	D	7.05	7.06	7.04	7.06	7.05	√					
	18.75±0.15	D	18.74	18.76	18.76	18.75	18.74	√					
	1.80±0.20	D	1.86	1.84	1.83	1.85	1.84	√					
	14.65±0.20	D	14.67	14.64	14.65	14.63	14.67	√					

檢驗依據: 《工程圖紙》 《檢驗規範》 《承認書》 樣品 其它

檢測儀器: A游標卡尺 B千分尺 C厚薄儀 D投影鏡 E放大鏡 F顯微鏡 G錫爐 H插拔力器 I間位尺 J其它

品保判定: 合格Accept 退貨Reject 特采Waive 挑選Sort

核准: 欠必鋒

審核: 李娟

檢驗員: 但芬

品名: USB AM SMT 180度(端子)		版次:A.0			
电镀规格:Ni40u", Sn40u", Au G/Fu"		日期:2022-03-20			
页次:1/1					
厂商:同华					
测试设备:CMI X-射线膜厚测试仪					
1、底层电镀测试(Ni)					
数据	测试标准	实测值	判定	测试日期	测试时间
1	40u"MIN	50.5u"	OK	2022/3/20	10:20:15
2	40u"MIN	56.3u"	OK	2022/3/20	10:20:17
3	40u"MIN	67.5u"	OK	2022/3/20	10:20:19
4	40u"MIN	62.4u"	OK	2022/3/20	10:20:21
2、表层电镀测试(Sn)					
数据	测试标准	实测值	判定	测试日期	测试时间
1	40u"MIN	65.3u"	OK	2022/3/20	10:25:10
2	40u"MIN	74.7u"	OK	2022/3/20	10:25:12
3	40u"MIN	75.9u"	OK	2022/3/20	10:25:14
4	40u"MIN	70.4u"	OK	2022/3/20	10:25:16
3、表层电镀测试(Au)					
数据	测试标准	实测值	判定	测试日期	测试时间
1	0.5u"MIN	0.56u"	OK	2022/3/20	10:30:32
2	0.5u"MIN	0.54u"	OK	2022/3/20	10:30:34
3	0.5u"MIN	0.57u"	OK	2022/3/20	10:30:36
4	0.5u"MIN	0.55u"	OK	2022/3/20	10:30:38

核准: 欠必锋

审核: 李娟

检验员: 但芬

电镀报告表

品名:USB AM SMT 180度 外壳		版次:A.0			
电镀规格:Cu:40u"Ni50u"MIN	日期:2022/03/12	页次:1/1			
厂商:金和源					
测试设备:CMI X-射线膜厚测试仪					
1、底层电镀测试(Cu)					
数据	测试标准	实测值	判定	测试日期	测试时间
1	40u"min	45.3u"	OK	2022/3/12	19:55:05
2	40u"min	48.5u"	OK	2022/3/12	19:55:57
3	40u"min	44.2u"	OK	2022/3/12	19:56:48
4	40u"min	45.6u"	OK	2022/3/12	19:57:31
2、表层电镀测试(Ni)					
数据	测试标准	实测值	判定	测试日期	测试时间
1	50u"min	50.26u"	OK	2022/3/12	19:58:12
2	50u"min	50.28u"	OK	2022/3/12	19:59:04
3	50u"min	50.18u"	OK	2022/3/12	20:01:44
4	50u"min	50.13u"	OK	2022/3/12	20:02:36

核准: 欠必锋

审核: 李娟

检验员: 但芬

盐水喷雾实验报告

试验方法	盐水喷雾腐蚀试验法	参考资料	MIL-STD-1216
METHOD	NEUTRL SALT SPRAY CORROSION TEST	REF	
客户	/	试验起始日期	2022年04月28日 20:00 时起
		DATE	2022年04月29日 08:00 时止
样品名称	USB AM SMT 180度		5PCS
P/N	U212-0611-G63018		

试验条件 (TEST CONDITION)

- 1、盐水溶解 (SALT SOLUTION: 浓度 $50 \pm 10\text{g/L}$, PH值6.5-7.2).
- 2、试验室温度 (TEMP. IT THE SPRAY DHAMBR): $35 \pm 1^\circ\text{C}$.
- 3、盐水桶温度 (TEMP. OF SALE SOL' N TANK): $35 \pm 1^\circ\text{C}$.
- 4、压力桶温度 (TEMP. OF SAR SUPPLIERY): $47 \pm 1^\circ\text{C}$.
- 5、试验室相对湿度 (R. H IN THE CHAMBER) 85%.
- 6、压缩空气压力 (COMPRESSED AIR PRESSURE): $1.00 \pm 0.01\text{Kg/cm}^2$.
- 7、样品放置位置 (SPECIMEN SUPPORTED ANGLE): 尼龙绳吊挂 $70^\circ - 90^\circ$.
- 8、喷雾收集量 (COLLECT RATE OF SALT SOL' N) $1-2\text{mL}/(8 \text{ cm}^2\text{hr})$.
- 9、盐雾测试时间: 12小时 (H)

判定方法 (ADFUSGD METHOD)

试验后以20倍放大镜观察、无蓝、绿色腐蚀物之现象 (不包含折弯处), 即判定合格. (Inspext the ecimen at 20 xmagnification no blue or green corrosion products are acceptable)

样品序号	试验后现象	判定
	PHENOMENON AFTER TEST	COMMENT
1	无蓝、绿色腐蚀物之现象	OK
2	无蓝、绿色腐蚀物之现象	OK
3	无蓝、绿色腐蚀物之现象	OK
4	无蓝、绿色腐蚀物之现象	OK
5	无蓝、绿色腐蚀物之现象	OK

核准: 欠必锋

审核: 李娟

试验员: 但芬

鉅鼎銅材廠檢驗報告單

公司名稱 Customer	鉅鼎銅材廠檢驗報告單				重量 Weight(kg)	1078	出貨日期 Date	2021/11/23		
品名 Article	標準 Standard No				尺寸 Dimension		狀態 Tenper	銅卷編號 Coil No		
C2680	JISH3100:2017				0.18*400		EH	1021-C-08		
化學成分Chemical Compositions(%)										
元素 Element	Cu %	Zn%	Pb%	Fe%	\	\	\	\	化學成分	雜質
規範 Spec	64.0-68.0	餘量	<0.05	<0.05	\	\	\	\	合格	合格
實測 Actual	64.32	餘量	0.0036	0.0136	\	\	\	\	合格	合格
機械性質Mechanical Properties										
項目 Item	結晶粒度 Grain Size Mm	硬度 Hardness Hv	抗拉強度 TensionStrength Mpa	伸長度 Elongation %	導電率 Electrical Conduc %IACS	彎曲試驗 Bending Test 180	表面粗度 Surface Roughness Ra(u m)	彎曲度 Camber mm/n		
規範MAX Spec	\	170-190	490-610	\	\	\	\	\		
實測 Actual	\	178	574	5	\	\	\	\		

品質部



佛山市顺德区天硕贸易有限公司

Foshan Shunde Tianshuo Trade Company Limited

日期: 2021-10-19

编号: FB2110136

收货单位PURCHASER: _____				产品名称: _____ SPCC-SD											
检验标准SPECIFICATION: JIS G 3141				检验情况: _____ 合格											
产品规格 SPECIFICATION MM	钢卷号 COIL. NO	材质牌号 SYMBOL OF QUALITY	净重 WEIGHT KG	化学成份CHEMICAL COMPOSITION							力学性能MECHANICAL PROPERTIES				
				Fe %	C %	Mn %	Si %	P %	S %	AI %	抗拉强度T.S Mpa	延伸率EL (%)	屈服强度Y.S Mpa	杯突 (mm)	硬度 (HV)
0.30x1250	DL45657	SPCC-SD	7835	99	0.031	0.17	0.07	0.22	0.24		361	29	259		143
0.30x1250	DL45658	SPCC-SD	7690	99	0.032	0.16	0.07	0.21	0.22		362	30	256		141

质量控制中心:

审核: 谢和钢

制表人: 胡万银



东莞市海嵘兴塑胶有限公司

LCP材质分析报告

品 名	比 例	用 途
杜邦LCP树脂	0.68	构成材料主要成份
抗氧剂	0.003	抗氧化
日本住友TAP	0.002	润滑及增加流动性
大洋安定剂	0.005	稳定机械性能, 方便重复使用
玻纤	0.30	增强
色母	0.01	着色

注：以上数据真实可靠，但并非绝对值，并不做任何商业依据。



Test Report

No. CANEC2119174206

Date: 22 Oct 2021

Page 1 of 4

SHENZHEN HUALIANWEI ELECTRONICS TECHNOLOGY CO.,LTD

101, 201, PLANT 1, NO.307, GUANLAN GUIHUA ROAD, GUIXIANG COMMUNITY, GUANLAN SUB-DISTRICT, LONGHUA DISTRICT, SHENZHEN CITY, GUANGDONG PROVINCE, CHINA

The following sample(s) was/were submitted and identified on behalf of the clients as : Nickel plating of iron shell

SGS Job No. : CP21-055214 - GZ
Model No. : Iron shell after plating
Client Ref. Info. : Used for USB series, HDMI series, RJ series, 1394 series, MICRO series, MINI series, DISPLAYPORT series, VGA series, DVI series, TYPE-C series, JACK series
Date of Sample Received : 18 Oct 2021
Testing Period : 18 Oct 2021 - 22 Oct 2021
Test Requested : Selected test(s) as requested by client.
Test Method : Please refer to next page(s).
Test Results : Please refer to next page(s).
Conclusion : Based on the performed tests on submitted sample(s), the results of Lead, Mercury, Cadmium, Hexavalent chromium comply with the limits as set by RoHS Directive (EU) 2015/863 amending Annex II to Directive 2011/65/EU.

Signed for and on behalf of
SGS-CSTC Standards Technical Services Co., Ltd. Guangzhou Branch

Allie Chen

Allie Chen
Approved Signatory

scan to see the report



165D1802



Unless otherwise agreed in writing, this document is issued by the Company subject to its General Conditions of Service printed overleaf, available on request or accessible at <http://www.sgs.com/en/Terms-and-Conditions.aspx> and, for electronic format documents, subject to Terms and Conditions for Electronic Documents at <http://www.sgs.com/en/Terms-and-Conditions/Terms-e-Document.aspx>. Attention is drawn to the limitation of liability, indemnification and jurisdiction issues defined therein. Any holder of this document is advised that information contained hereon reflects the Company's findings at the time of its intervention only and within the limits of Client's instructions, if any. The Company's sole responsibility is to its Client and this document does not exonerate parties to a transaction from exercising all their rights and obligations under the transaction documents. This document cannot be reproduced except in full, without prior written approval of the Company. Any unauthorized alteration, forgery or falsification of the content or appearance of this document is unlawful and offenders may be prosecuted to the fullest extent of the law. Unless otherwise stated the results shown in this test report refer only to the sample(s) tested.

Attention: To check the authenticity of testing / inspection report & certificate, please contact us at telephone: (86-755) 8307 1443, or email: CN.Doccheck@sgs.com

Test Report

No. CANEC2119174206

Date: 22 Oct 2021

Page 2 of 4

Test Results :

Test Part Description :

Specimen No.	SGS Sample ID	Description
SN1	CAN21-191742.006	Silver-grey plated metal

Remarks :

- (1) 1 mg/kg = 0.0001%
- (2) MDL = Method Detection Limit
- (3) ND = Not Detected (< MDL)
- (4) "-" = Not Regulated

RoHS Directive (EU) 2015/863 amending Annex II to Directive 2011/65/EU

Test Method : With reference to IEC 62321-4:2013+A1:2017, IEC 62321-5:2013, IEC 62321-7-1:2015, analyzed by ICP-OES and UV-Vis .

Test Item(s)	Limit	Unit	MDL	006
Cadmium (Cd)	100	mg/kg	2	ND
Lead (Pb)	1,000	mg/kg	2	ND
Mercury (Hg)	1,000	mg/kg	2	ND
Hexavalent Chromium (Cr(VI))▼	-	µg/cm ²	0.10	ND

Notes :

- (1) The maximum permissible limit is quoted from RoHS Directive (EU) 2015/863.
- (2) IEC 62321 series is equivalent to EN 62321 series
https://www.cenelec.eu/dyn/www/f?p=104:30:1742232870351101:::FSP_ORG_ID,FSP_LANG_ID:1258637,25
- (3) ▼= a. The sample is positive for CrVI if the CrVI concentration is greater than 0.13 µg/cm². The sample coating is considered to contain CrVI
 b. The sample is negative for CrVI if CrVI is ND (concentration less than 0.10 µg/cm²). The coating is considered a non-CrVI based coating
 c. The result between 0.10 µg/cm² and 0.13 µg/cm² is considered to be inconclusive - unavoidable coating variations may influence the determination
 Information on storage conditions and production date of the tested sample is unavailable and thus Cr(VI) results represent status of the sample at the time of testing.



Unless otherwise agreed in writing, this document is issued by the Company subject to its General Conditions of Service printed overleaf, available on request or accessible at <http://www.sgs.com/en/Terms-and-Conditions.aspx> and, for electronic format documents, subject to Terms and Conditions for Electronic Documents at <http://www.sgs.com/en/Terms-and-Conditions/Terms-e-Documents.aspx>. Attention is drawn to the limitation of liability, indemnification and jurisdiction issues defined therein. Any holder of this document is advised that information contained hereon reflects the Company's findings at the time of its intervention only and within the limits of Client's instructions, if any. The Company's sole responsibility is to its Client and this document does not exonerate parties to a transaction from exercising all their rights and obligations under the transaction documents. This document cannot be reproduced except in full, without prior written approval of the Company. Any unauthorized alteration, forgery or falsification of the content or appearance of this document is unlawful and offenders may be prosecuted to the fullest extent of the law. Unless otherwise stated the results shown in this test report refer only to the sample(s) tested.

Attention: To check the authenticity of testing / inspection report & certificate, please contact us at telephone: (86-755) 8307 1443, or email: CN.Doccheck@sgs.com

ATTACHMENTS

Pb/Cd/Hg/Cr⁶⁺ Testing Flow Chart

1) These samples were dissolved totally by pre-conditioning method according to below flow chart. (Cr⁶⁺ test method excluded).

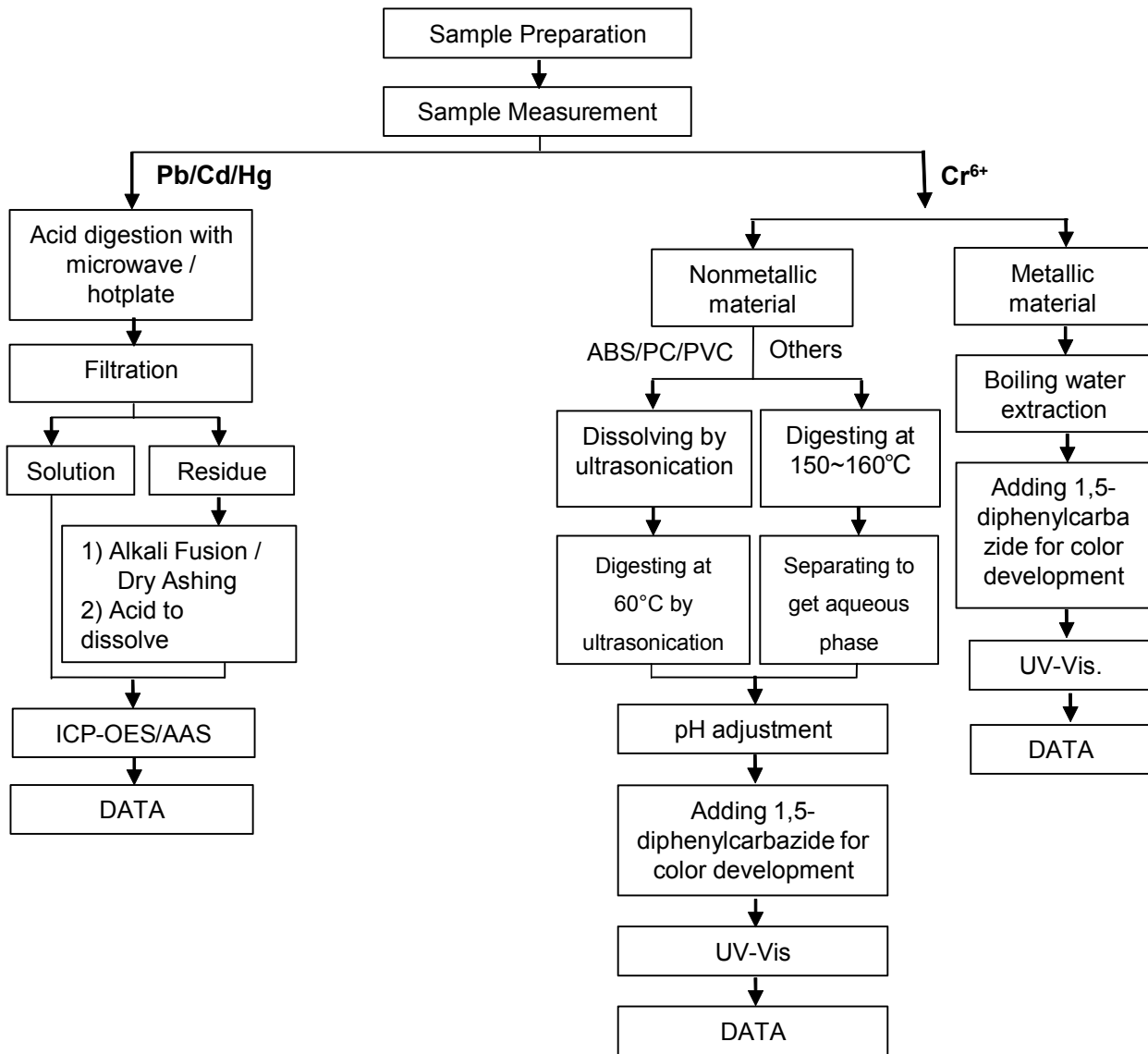

Sample photo:



SGS authenticate the photo on original report only

*** End of Report ***



Test Report

No. CANEC2119174201

Date: 22 Oct 2021

Page 1 of 4

SHENZHEN HUALIANWEI ELECTRONICS TECHNOLOGY CO.,LTD

101, 201, PLANT 1, NO.307, GUANLAN GUIHUA ROAD, GUIXIANG COMMUNITY, GUANLAN SUB-DISTRICT, LONGHUA DISTRICT, SHENZHEN CITY, GUANGDONG PROVINCE, CHINA

The following sample(s) was/were submitted and identified on behalf of the clients as : C2680 Terminal

SGS Job No. : CP21-055214 - GZ
Model No. : C2680 terminal after plating
Client Ref. Info. : Used for USB series, HDMI series, RJ series, 1394 series, MICRO series, MINI series, DISPLAYPORT series, VGA series, DVI series, TYPE-C series, JACK series
Date of Sample Received : 18 Oct 2021
Testing Period : 18 Oct 2021 - 22 Oct 2021
Test Requested : Selected test(s) as requested by client.
Test Method : Please refer to next page(s).
Test Results : Please refer to next page(s).
Conclusion : Based on the performed tests on submitted sample(s), the results of Lead, Mercury, Cadmium, Hexavalent chromium comply with the limits as set by RoHS Directive (EU) 2015/863 amending Annex II to Directive 2011/65/EU.

Signed for and on behalf of
SGS-CSTC Standards Technical Services Co., Ltd. Guangzhou Branch

Allie Chen

Allie Chen
Approved Signatory

scan to see the report



94BEAB15



SGS-CSTC Standards Technical Services Co., Ltd.
Guangzhou Branch Testing Center Chemical Laboratory.

Unless otherwise agreed in writing, this document is issued by the Company subject to its General Conditions of Service printed overleaf, available on request or accessible at <http://www.sgs.com/en/Terms-and-Conditions.aspx> and, for electronic format documents, subject to Terms and Conditions for Electronic Documents at <http://www.sgs.com/en/Terms-and-Conditions/Terms-e-Document.aspx>. Attention is drawn to the limitation of liability, indemnification and jurisdiction issues defined therein. Any holder of this document is advised that information contained hereon reflects the Company's findings at the time of its intervention only and within the limits of Client's instructions, if any. The Company's sole responsibility is to its Client and this document does not exonerate parties to a transaction from exercising all their rights and obligations under the transaction documents. This document cannot be reproduced except in full, without prior written approval of the Company. Any unauthorized alteration, forgery or falsification of the content or appearance of this document is unlawful and offenders may be prosecuted to the fullest extent of the law. Unless otherwise stated the results shown in this test report refer only to the sample(s) tested.

Attention: To check the authenticity of testing / inspection report & certificate, please contact us at telephone: (86-755) 8307 1443, or email: CN.Doccheck@sgs.com

198 Kazhu Road, Sciotech Park Guangzhou Economic & Technology Development District, Guangzhou, China 510663

中国·广州·经济技术开发区科学城科珠路198号 邮编: 510663

t (86-20) 82155555 www.sgs.com

t (86-20) 82155555 sgs.china@sgs.com

Test Report

No. CANEC2119174201

Date: 22 Oct 2021

Page 2 of 4

Test Results :

Test Part Description :

Specimen No.	SGS Sample ID	Description
SN1	CAN21-191742.001	Silver-grey/brassy metal

Remarks :

- (1) 1 mg/kg = 0.0001%
- (2) MDL = Method Detection Limit
- (3) ND = Not Detected (< MDL)
- (4) "-" = Not Regulated

RoHS Directive (EU) 2015/863 amending Annex II to Directive 2011/65/EU

Test Method : With reference to IEC 62321-4:2013+A1:2017, IEC 62321-5:2013, IEC 62321-7-1:2015, analyzed by ICP-OES and UV-Vis .

Test Item(s)	Limit	Unit	MDL	001
Cadmium (Cd)	100	mg/kg	2	ND
Lead (Pb)	1,000	mg/kg	2	44
Mercury (Hg)	1,000	mg/kg	2	ND
Hexavalent Chromium (Cr(VI))▼	-	µg/cm ²	0.10	ND

Notes :

- (1) The maximum permissible limit is quoted from RoHS Directive (EU) 2015/863.
- (2) IEC 62321 series is equivalent to EN 62321 series
https://www.cenelec.eu/dyn/www/f?p=104:30:1742232870351101:::FSP_ORG_ID,FSP_LANG_ID:1258637,25
- (3) ▼= a. The sample is positive for CrVI if the CrVI concentration is greater than 0.13 µg/cm². The sample coating is considered to contain CrVI
 b. The sample is negative for CrVI if CrVI is ND (concentration less than 0.10 µg/cm²). The coating is considered a non-CrVI based coating
 c. The result between 0.10 µg/cm² and 0.13 µg/cm² is considered to be inconclusive - unavoidable coating variations may influence the determination
 Information on storage conditions and production date of the tested sample is unavailable and thus Cr(VI) results represent status of the sample at the time of testing.



ATTACHMENTS

Pb/Cd/Hg/Cr⁶⁺ Testing Flow Chart

1) These samples were dissolved totally by pre-conditioning method according to below flow chart. (Cr⁶⁺ test method excluded).

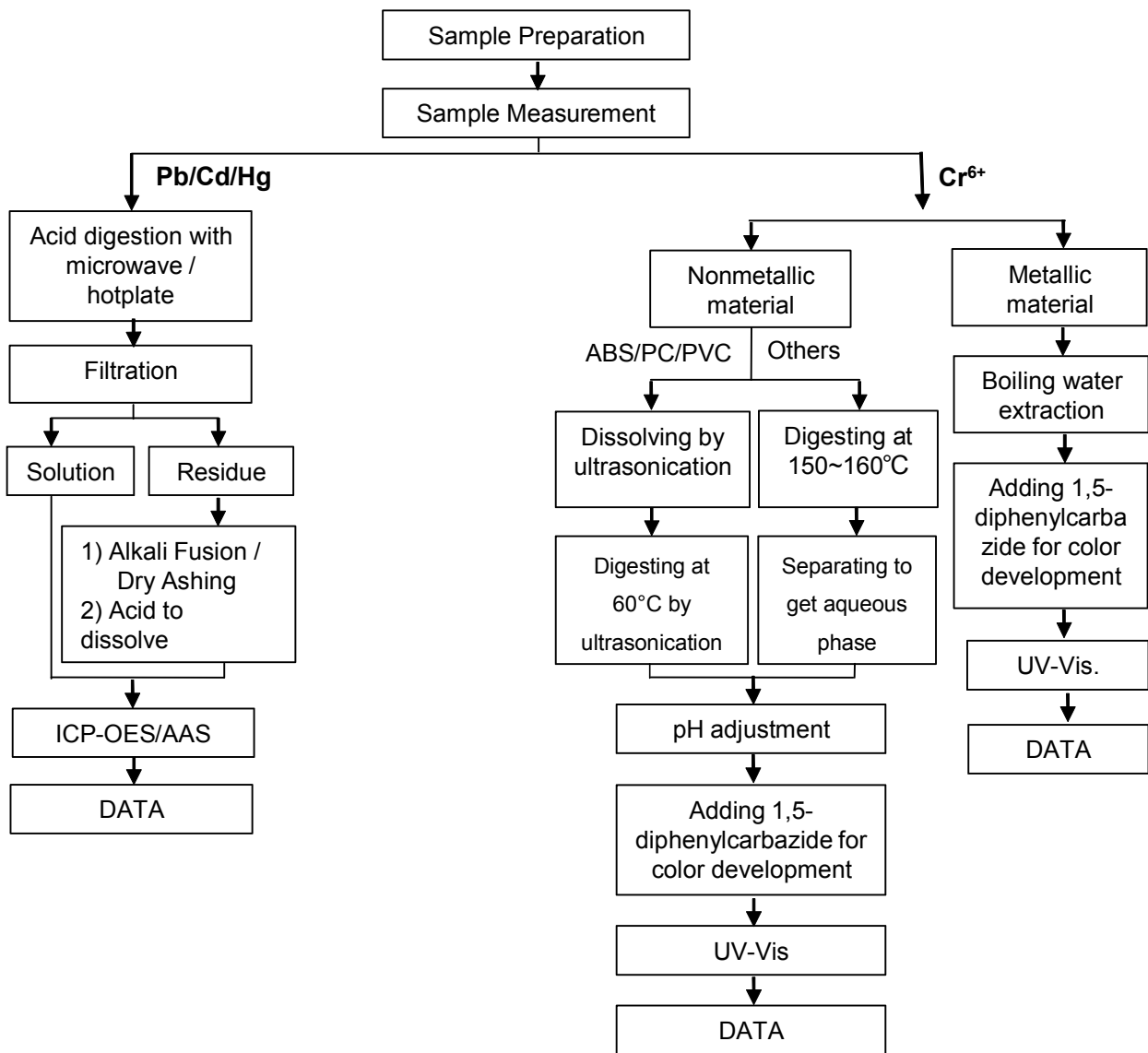

Sample photo:



SGS authenticate the photo on original report only

*** End of Report ***



Test Report

No. CANEC2119174207

Date: 22 Oct 2021

Page 1 of 6

SHENZHEN HUALIANWEI ELECTRONICS TECHNOLOGY CO.,LTD

101, 201, PLANT 1, NO.307, GUANLAN GUIHUA ROAD, GUIXIANG COMMUNITY, GUANLAN SUB-DISTRICT, LONGHUA DISTRICT, SHENZHEN CITY, GUANGDONG PROVINCE, CHINA

The following sample(s) was/were submitted and identified on behalf of the clients as : LCP plastic natural color

SGS Job No. : CP21-055214 - GZ
Model No. : LCP Plastic
Client Ref. Info. : Used for USB series, HDMI series, RJ series, 1394 series, MICRO series, MINI series, DISPLAYPORT series, VGA series, DVI series, TYPE-C series, JACK series
Date of Sample Received : 18 Oct 2021
Testing Period : 18 Oct 2021 - 22 Oct 2021
Test Requested : Selected test(s) as requested by client.
Test Method : Please refer to next page(s).
Test Results : Please refer to next page(s).
Conclusion : Based on the performed tests on submitted sample(s), the results of Lead, Mercury, Cadmium, Hexavalent chromium, Polybrominated biphenyls (PBBs), Polybrominated diphenyl ethers (PBDEs) and Phthalates such as Bis(2-ethylhexyl) phthalate (DEHP) , Butyl benzyl phthalate (BBP), Dibutyl phthalate (DBP) , and Diisobutyl phthalate (DIBP) comply with the limits as set by RoHS Directive (EU) 2015/863 amending Annex II to Directive 2011/65/EU.

Signed for and on behalf of
SGS-CSTC Standards Technical Services Co., Ltd. Guangzhou Branch

Allie Chen

Allie Chen
Approved Signatory

scan to see the report



A6779AE3



Unless otherwise agreed in writing, this document is issued by the Company subject to its General Conditions of Service printed overleaf, available on request or accessible at <http://www.sgs.com/en/Terms-and-Conditions.aspx> and, for electronic format documents, subject to Terms and Conditions for Electronic Documents at <http://www.sgs.com/en/Terms-and-Conditions/Terms-e-Documents.aspx>. Attention is drawn to the limitation of liability, indemnification and jurisdiction issues defined therein. Any holder of this document is advised that information contained hereon reflects the Company's findings at the time of its intervention only and within the limits of Client's instructions, if any. The Company's sole responsibility is to its Client and this document does not exonerate parties to a transaction from exercising all their rights and obligations under the transaction documents. This document cannot be reproduced except in full, without prior written approval of the Company. Any unauthorized alteration, forgery or falsification of the content or appearance of this document is unlawful and offenders may be prosecuted to the fullest extent of the law. Unless otherwise stated the results shown in this test report refer only to the sample(s) tested.

Attention: To check the authenticity of testing / inspection report & certificate, please contact us at telephone: (86-755) 8307 1443, or email: CN.Doccheck@sgs.com

Test Report

No. CANEC2119174207

Date: 22 Oct 2021

Page 2 of 6

Test Results :

Test Part Description :

Specimen No.	SGS Sample ID	Description
SN1	CAN21-191742.007	Beige plastic

Remarks :

- (1) 1 mg/kg = 0.0001%
- (2) MDL = Method Detection Limit
- (3) ND = Not Detected (< MDL)
- (4) "-" = Not Regulated

RoHS Directive (EU) 2015/863 amending Annex II to Directive 2011/65/EU

Test Method : With reference to IEC 62321-4:2013+A1:2017, IEC 62321-5:2013, IEC 62321-7-2:2017 , IEC 62321-6:2015 and IEC 62321-8:2017, analyzed by ICP-OES , UV-Vis and GC-MS .

Test Item(s)	Limit	Unit	MDL	007
Cadmium (Cd)	100	mg/kg	2	ND
Lead (Pb)	1,000	mg/kg	2	8
Mercury (Hg)	1,000	mg/kg	2	ND
Hexavalent Chromium (CrVI)	1,000	mg/kg	8	ND
Sum of PBBs	1,000	mg/kg	-	ND
Monobromobiphenyl	-	mg/kg	5	ND
Dibromobiphenyl	-	mg/kg	5	ND
Tribromobiphenyl	-	mg/kg	5	ND
Tetrabromobiphenyl	-	mg/kg	5	ND
Pentabromobiphenyl	-	mg/kg	5	ND
Hexabromobiphenyl	-	mg/kg	5	ND
Heptabromobiphenyl	-	mg/kg	5	ND
Octabromobiphenyl	-	mg/kg	5	ND
Nonabromobiphenyl	-	mg/kg	5	ND
Decabromobiphenyl	-	mg/kg	5	ND
Sum of PBDEs	1,000	mg/kg	-	ND
Monobromodiphenyl ether	-	mg/kg	5	ND
Dibromodiphenyl ether	-	mg/kg	5	ND
Tribromodiphenyl ether	-	mg/kg	5	ND
Tetrabromodiphenyl ether	-	mg/kg	5	ND
Pentabromodiphenyl ether	-	mg/kg	5	ND



Unless otherwise agreed in writing, this document is issued by the Company subject to its General Conditions of Service printed overleaf, available on request or accessible at <http://www.sgs.com/en/Terms-and-Conditions.aspx> and, for electronic format documents, subject to Terms and Conditions for Electronic Documents at <http://www.sgs.com/en/Terms-and-Conditions/Terms-e-Documents.aspx>. Attention is drawn to the limitation of liability, indemnification and jurisdiction issues defined therein. Any holder of this document is advised that information contained hereon reflects the Company's findings at the time of its intervention only and within the limits of Client's instructions, if any. The Company's sole responsibility is to its Client and this document does not exonerate parties to a transaction from exercising all their rights and obligations under the transaction documents. This document cannot be reproduced except in full, without prior written approval of the Company. Any unauthorized alteration, forgery or falsification of the content or appearance of this document is unlawful and offenders may be prosecuted to the fullest extent of the law. Unless otherwise stated the results shown in this test report refer only to the sample(s) tested.

Attention: To check the authenticity of testing / inspection report & certificate, please contact us at telephone: (86-755) 8307 1443, or email: CN.Doccheck@sgs.com

Test Report

No. CANEC2119174207

Date: 22 Oct 2021

Page 3 of 6

<u>Test Item(s)</u>	<u>Limit</u>	<u>Unit</u>	<u>MDL</u>	<u>007</u>
Hexabromodiphenyl ether	-	mg/kg	5	ND
Heptabromodiphenyl ether	-	mg/kg	5	ND
Octabromodiphenyl ether	-	mg/kg	5	ND
Nonabromodiphenyl ether	-	mg/kg	5	ND
Decabromodiphenyl ether	-	mg/kg	5	ND
Dibutyl phthalate (DBP)	1,000	mg/kg	50	ND
Butyl benzyl phthalate (BBP)	1,000	mg/kg	50	ND
Bis (2-ethylhexyl) phthalate (DEHP)	1,000	mg/kg	50	ND
Diisobutyl Phthalates (DIBP)	1,000	mg/kg	50	ND

Notes :

- (1) The maximum permissible limit is quoted from RoHS Directive (EU) 2015/863.
- (2) IEC 62321 series is equivalent to EN 62321 series
https://www.cenelec.eu/dyn/www/f?p=104:30:1742232870351101:::FSP_ORG_ID,FSP_LANG_ID:1258637,25
- (3) The restriction of DEHP, BBP, DBP and DIBP shall apply to medical devices, including in vitro medical devices, and monitoring and control instruments, including industrial monitoring and control instruments, from 22 July 2021.



Unless otherwise agreed in writing, this document is issued by the Company subject to its General Conditions of Service printed overleaf, available on request or accessible at <http://www.sgs.com/en/Terms-and-Conditions.aspx> and, for electronic format documents, subject to Terms and Conditions for Electronic Documents at <http://www.sgs.com/en/Terms-and-Conditions/Terms-e-Document.aspx>. Attention is drawn to the limitation of liability, indemnification and jurisdiction issues defined therein. Any holder of this document is advised that information contained hereon reflects the Company's findings at the time of its intervention only and within the limits of Client's instructions, if any. The Company's sole responsibility is to its Client and this document does not exonerate parties to a transaction from exercising all their rights and obligations under the transaction documents. This document cannot be reproduced except in full, without prior written approval of the Company. Any unauthorized alteration, forgery or falsification of the content or appearance of this document is unlawful and offenders may be prosecuted to the fullest extent of the law. Unless otherwise stated the results shown in this test report refer only to the sample(s) tested.

Attention: To check the authenticity of testing / inspection report & certificate, please contact us at telephone: (86-755) 8307 1443, or email: CN.Doccheck@sgs.com

ATTACHMENTS

Pb/Cd/Hg/Cr⁶⁺/PBBs/PBDEs Testing Flow Chart

1) These samples were dissolved totally by pre-conditioning method according to below flow chart. (Cr⁶⁺ and PBBs/PBDEs test method excluded).

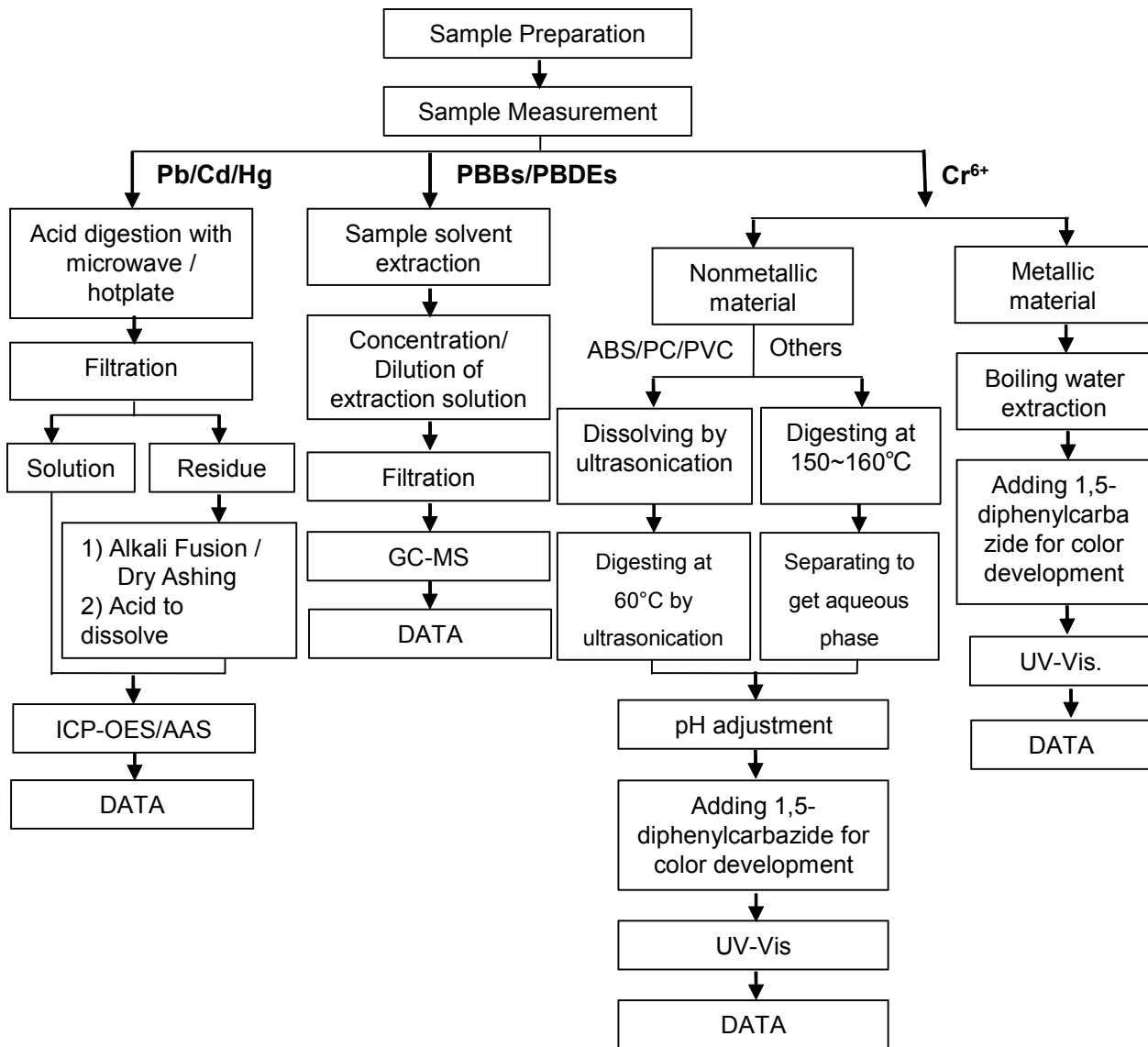

Unless otherwise agreed in writing, this document is issued by the Company subject to its General Conditions of Service printed overleaf, available on request or accessible at <http://www.sgs.com/en/Terms-and-Conditions.aspx> and, for electronic format documents, subject to Terms and Conditions for Electronic Documents at <http://www.sgs.com/en/Terms-and-Conditions/Terms-e-Documents.aspx>. Attention is drawn to the limitation of liability, indemnification and jurisdiction issues defined therein. Any holder of this document is advised that information contained hereon reflects the Company's findings at the time of its intervention only and within the limits of Client's instructions, if any. The Company's sole responsibility is to its Client and this document does not exonerate parties to a transaction from exercising all their rights and obligations under the transaction documents. This document cannot be reproduced except in full, without prior written approval of the Company. Any unauthorized alteration, forgery or falsification of the content or appearance of this document is unlawful and offenders may be prosecuted to the fullest extent of the law. Unless otherwise stated the results shown in this test report refer only to the sample(s) tested.

Attention: To check the authenticity of testing / inspection report & certificate, please contact us at telephone: (86-755) 8307 1443, or email: CN.Doccheck@sgs.com

ATTACHMENTS

Phthalates Testing Flow Chart

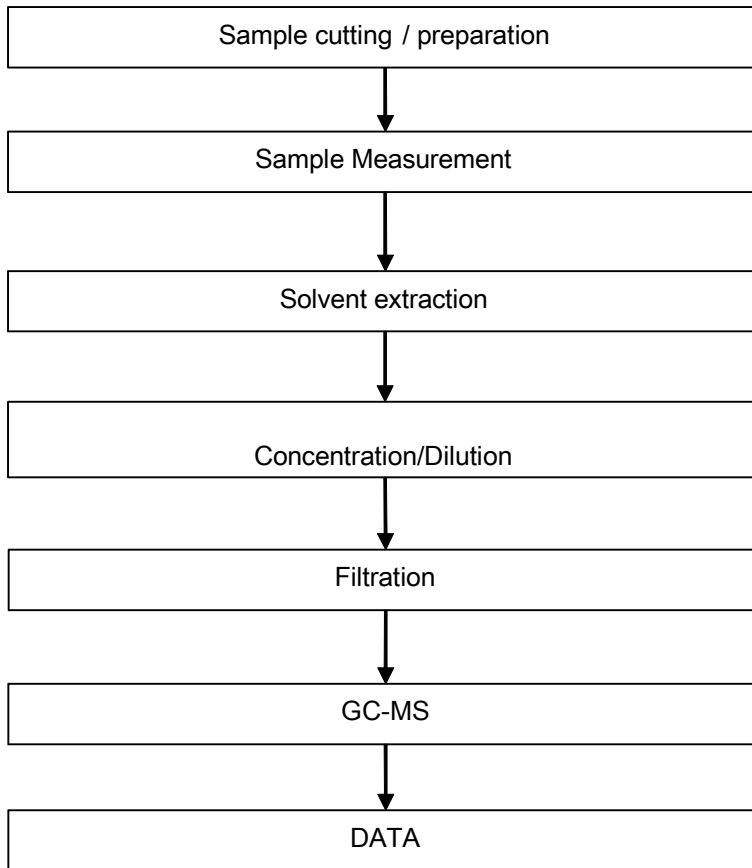

Unless otherwise agreed in writing, this document is issued by the Company subject to its General Conditions of Service printed overleaf, available on request or accessible at <http://www.sgs.com/en/Terms-and-Conditions.aspx> and, for electronic format documents, subject to Terms and Conditions for Electronic Documents at <http://www.sgs.com/en/Terms-and-Conditions/Terms-e-Document.aspx>. Attention is drawn to the limitation of liability, indemnification and jurisdiction issues defined therein. Any holder of this document is advised that information contained hereon reflects the Company's findings at the time of its intervention only and within the limits of Client's instructions, if any. The Company's sole responsibility is to its Client and this document does not exonerate parties to a transaction from exercising all their rights and obligations under the transaction documents. This document cannot be reproduced except in full, without prior written approval of the Company. Any unauthorized alteration, forgery or falsification of the content or appearance of this document is unlawful and offenders may be prosecuted to the fullest extent of the law. Unless otherwise stated the results shown in this test report refer only to the sample(s) tested.

Attention: To check the authenticity of testing / inspection report & certificate, please contact us at telephone: (86-755) 8307 1443, or email: CN_Doccheck@sgs.com

Sample photo:



SGS authenticate the photo on original report only

*** End of Report ***



Test Report

No. CANEC2117633801

Date: 27 Sep 2021

Page 1 of 8

SHENZHEN CITY TONGHUA INDUSTRY CO.,LTD

TONGHUA MANSIN TONGLE XINBU VILLANG TOWN SHENZHEN CITY CHINA

The following sample(s) was/were submitted and identified on behalf of the clients as : Glod(AU)

SGS Job No. : CP21-051017 - SZ

Date of Sample Received : 18 Sep 2021

Testing Period : 18 Sep 2021 - 27 Sep 2021

Test Requested : Selected test(s) as requested by client.

Test Method : Please refer to next page(s).

Test Results : Please refer to next page(s).

Conclusion : Based on the performed tests on submitted sample(s), the results of Lead, Mercury, Cadmium, Hexavalent chromium, Polybrominated biphenyls (PBBs), Polybrominated diphenyl ethers (PBDEs) and Phthalates such as Bis(2-ethylhexyl) phthalate (DEHP) , Butyl benzyl phthalate (BBP), Dibutyl phthalate (DBP) , and Diisobutyl phthalate (DIBP) comply with the limits as set by RoHS Directive (EU) 2015/863 amending Annex II to Directive 2011/65/EU.

Signed for and on behalf of
SGS-CSTC Standards Technical Services Co., Ltd. Guangzhou Branch

Allie Chen

Allie Chen
Approved Signatory

scan to see the report



CANEC2117633801



SGS-CSTC Standards Technical Services Co., Ltd.
Guangzhou Branch Testing Center Chemical Laboratory.

Unless otherwise agreed in writing, this document is issued by the Company subject to its General Conditions of Service printed overleaf, available on request or accessible at <http://www.sgs.com/en/Terms-and-Conditions.aspx> and, for electronic format documents, subject to Terms and Conditions for Electronic Documents at <http://www.sgs.com/en/Terms-and-Conditions/Terms-e-Documents.aspx>. Attention is drawn to the limitation of liability, indemnification and jurisdiction issues defined therein. Any holder of this document is advised that information contained hereon reflects the Company's findings at the time of its intervention only and within the limits of Client's instructions, if any. The Company's sole responsibility is to its Client and this document does not exonerate parties to a transaction from exercising all their rights and obligations under the transaction documents. This document cannot be reproduced except in full, without prior written approval of the Company. Any unauthorized alteration, forgery or falsification of the content or appearance of this document is unlawful and offenders may be prosecuted to the fullest extent of the law. Unless otherwise stated the results shown in this test report refer only to the sample(s) tested.

Attention: To check the authenticity of testing /inspection report & certificate, please contact us at telephone: (86-755) 8307 1443, or email: CN.Doccheck@sgs.com

198 Kazhu Road, Sciotech Park Guangzhou Economic & Technology Development District, Guangzhou, China 510663
中国·广州·经济技术开发区科学城科珠路198号 邮编: 510663

t (86-20) 82155555 www.sgs.com.cn
t (86-20) 82155555 sgs.china@sgs.com

Test Report

No. CANEC2117633801

Date: 27 Sep 2021

Page 2 of 8

Test Results :

Test Part Description :

Specimen No.	SGS Sample ID	Description
SN1	CAN21-176338.001	Gold plated metal

Remarks :

- (1) 1 mg/kg = 1 ppm = 0.0001%
- (2) MDL = Method Detection Limit
- (3) ND = Not Detected (< MDL)
- (4) "-" = Not Regulated

RoHS Directive (EU) 2015/863 amending Annex II to Directive 2011/65/EU

Test Method : With reference to IEC 62321-4:2013+A1:2017, IEC 62321-5:2013, IEC 62321-7-1:2015 , IEC 62321-6:2015 and IEC 62321-8:2017, analyzed by ICP-OES , UV-Vis and GC-MS .

Test Item(s)	Limit	Unit	MDL	001
Cadmium (Cd)	100	mg/kg	2	ND
Lead (Pb)	1,000	mg/kg	2	73
Mercury (Hg)	1,000	mg/kg	2	ND
Hexavalent Chromium (Cr(VI))▼	-	µg/cm ²	0.10	ND
Sum of PBBs	1,000	mg/kg	-	ND
Monobromobiphenyl	-	mg/kg	5	ND
Dibromobiphenyl	-	mg/kg	5	ND
Tribromobiphenyl	-	mg/kg	5	ND
Tetrabromobiphenyl	-	mg/kg	5	ND
Pentabromobiphenyl	-	mg/kg	5	ND
Hexabromobiphenyl	-	mg/kg	5	ND
Heptabromobiphenyl	-	mg/kg	5	ND
Octabromobiphenyl	-	mg/kg	5	ND
Nonabromobiphenyl	-	mg/kg	5	ND
Decabromobiphenyl	-	mg/kg	5	ND
Sum of PBDEs	1,000	mg/kg	-	ND
Monobromodiphenyl ether	-	mg/kg	5	ND
Dibromodiphenyl ether	-	mg/kg	5	ND
Tribromodiphenyl ether	-	mg/kg	5	ND
Tetrabromodiphenyl ether	-	mg/kg	5	ND
Pentabromodiphenyl ether	-	mg/kg	5	ND



Unless otherwise agreed in writing, this document is issued by the Company subject to its General Conditions of Service printed overleaf, available on request or accessible at <http://www.sgs.com/en/Terms-and-Conditions.aspx> and, for electronic format documents, subject to Terms and Conditions for Electronic Documents at <http://www.sgs.com/en/Terms-and-Conditions/Terms-e-Documents.aspx>. Attention is drawn to the limitation of liability, indemnification and jurisdiction issues defined therein. Any holder of this document is advised that information contained hereon reflects the Company's findings at the time of its intervention only and within the limits of Client's instructions, if any. The Company's sole responsibility is to its Client and this document does not exonerate parties to a transaction from exercising all their rights and obligations under the transaction documents. This document cannot be reproduced except in full, without prior written approval of the Company. Any unauthorized alteration, forgery or falsification of the content or appearance of this document is unlawful and offenders may be prosecuted to the fullest extent of the law. Unless otherwise stated the results shown in this test report refer only to the sample(s) tested.

Attention: To check the authenticity of testing / inspection report & certificate, please contact us at telephone: (86-755) 8307 1443, or email: CN.Doccheck@sgs.com

Test Report

No. CANEC2117633801

Date: 27 Sep 2021

Page 3 of 8

<u>Test Item(s)</u>	<u>Limit</u>	<u>Unit</u>	<u>MDL</u>	<u>001</u>
Hexabromodiphenyl ether	-	mg/kg	5	ND
Heptabromodiphenyl ether	-	mg/kg	5	ND
Octabromodiphenyl ether	-	mg/kg	5	ND
Nonabromodiphenyl ether	-	mg/kg	5	ND
Decabromodiphenyl ether	-	mg/kg	5	ND
Dibutyl phthalate (DBP)	1000	mg/kg	50	ND
Butyl benzyl phthalate (BBP)	1000	mg/kg	50	ND
Bis (2-ethylhexyl) phthalate (DEHP)	1000	mg/kg	50	ND
Diisobutyl Phthalates (DIBP)	1000	mg/kg	50	ND

Notes :

- (1) The maximum permissible limit is quoted from RoHS Directive (EU) 2015/863.
- (2) IEC 62321 series is equivalent to EN 62321 series
https://www.cenelec.eu/dyn/www/f?p=104:30:1742232870351101:::FSP_ORG_ID,FSP_LANG_ID:1258637,25
- (3) ▼ = a. The sample is positive for CrVI if the CrVI concentration is greater than 0.13 µg/cm². The sample coating is considered to contain CrVI
 b. The sample is negative for CrVI if CrVI is ND (concentration less than 0.10 µg/cm²). The coating is considered a non-CrVI based coating
 c. The result between 0.10 µg/cm² and 0.13 µg/cm² is considered to be inconclusive - unavoidable coating variations may influence the determination
 Information on storage conditions and production date of the tested sample is unavailable and thus Cr(VI) results represent status of the sample at the time of testing.

Perfluorooctanoic acid (PFOA) and its salts & Perfluorooctane sulfonates (PFOS) and its derivatives

Test Method : With reference to CEN/TS15968:2010, analysis was performed by LC-MS or LC-MS/MS.

<u>Test Item(s)</u>	<u>CAS NO.</u>	<u>Unit</u>	<u>MDL</u>	<u>001</u>
Perfluorooctanoic acid (PFOA) and its salts+	335-67-1	mg/kg	0.010	ND
Perfluorooctane sulfonates (PFOS) ^	1763-23-1	mg/kg	0.010	ND
Perfluorooctane Sulfonamide (PFOSA)	754-91-6	mg/kg	0.010	ND
N-methylperfluoro-1-octanesulfonamide(MeFOSA)	31506-32-8	mg/kg	0.010	ND
N-ethylperfluoro-1-octanesulfonamide (EtFOSA)	4151-50-2	mg/kg	0.010	ND
2-(N-methylperfluoro-1-octanesulfonamido)-ethanol(MeFOSE)	24448-09-7	mg/kg	0.010	ND
2-(N-ethylperfluoro-1-octanesulfonamido)-ethanol(EtFOSE)	1691-99-2	mg/kg	0.010	ND
Perfluorooctane sulfonates (PFOS) and its derivatives	-	mg/kg	-	ND



Unless otherwise agreed in writing, this document is issued by the Company subject to its General Conditions of Service printed overleaf, available on request or accessible at <http://www.sgs.com/en/Terms-and-Conditions.aspx> and, for electronic format documents, subject to Terms and Conditions for Electronic Documents at <http://www.sgs.com/en/Terms-and-Conditions/Terms-e-Documents.aspx>. Attention is drawn to the limitation of liability, indemnification and jurisdiction issues defined therein. Any holder of this document is advised that information contained hereon reflects the Company's findings at the time of its intervention only and within the limits of Client's instructions, if any. The Company's sole responsibility is to its Client and this document does not exonerate parties to a transaction from exercising all their rights and obligations under the transaction documents. This document cannot be reproduced except in full, without prior written approval of the Company. Any unauthorized alteration, forgery or falsification of the content or appearance of this document is unlawful and offenders may be prosecuted to the fullest extent of the law. Unless otherwise stated the results shown in this test report refer only to the sample(s) tested.

Attention: To check the authenticity of testing / inspection report & certificate, please contact us at telephone: (86-755) 8307 1443, or email: CN.Doccheck@sgs.com

Notes :

- (1) + PFOA and its salts including PFOA-Na (CAS No.: 335-95-5), PFOA-K (CAS No.: 2395-00-8), PFOA-Ag (CAS No.: 335-93-3), PFOA-F (CAS No.: 335-66-0) and APFO (CAS No.: 3825-26-1);
- (2) ^ PFOS including PFOS-K (CAS No.: 2795-39-3), PFOS-Li (CAS No.: 29457-72-5), PFOS-NH₄ (CAS No.: 29081-56-9), PFOS-NH(OH)₂ (CAS No.: 70225-14-8), PFOS-N(C₂H₅)₄ (CAS No.: 56773-42-3), PFOS-DDA(CAS No.:251099-16-8) and POSF (CAS No.: 307-35-7)



Unless otherwise agreed in writing, this document is issued by the Company subject to its General Conditions of Service printed overleaf, available on request or accessible at <http://www.sgs.com/en/Terms-and-Conditions.aspx> and, for electronic format documents, subject to Terms and Conditions for Electronic Documents at <http://www.sgs.com/en/Terms-and-Conditions/Terms-e-Documents.aspx>. Attention is drawn to the limitation of liability, indemnification and jurisdiction issues defined therein. Any holder of this document is advised that information contained hereon reflects the Company's findings at the time of its intervention only and within the limits of Client's instructions, if any. The Company's sole responsibility is to its Client and this document does not exonerate parties to a transaction from exercising all their rights and obligations under the transaction documents. This document cannot be reproduced except in full, without prior written approval of the Company. Any unauthorized alteration, forgery or falsification of the content or appearance of this document is unlawful and offenders may be prosecuted to the fullest extent of the law. Unless otherwise stated the results shown in this test report refer only to the sample(s) tested.

Attention: To check the authenticity of testing /inspection report & certificate, please contact us at telephone: (86-755) 8307 1443, or email: CN.Doccheck@sgs.com

ATTACHMENTS

Pb/Cd/Hg/Cr⁶⁺/PBBs/PBDEs Testing Flow Chart

1) These samples were dissolved totally by pre-conditioning method according to below flow chart. (Cr⁶⁺ and PBBs/PBDEs test method excluded).

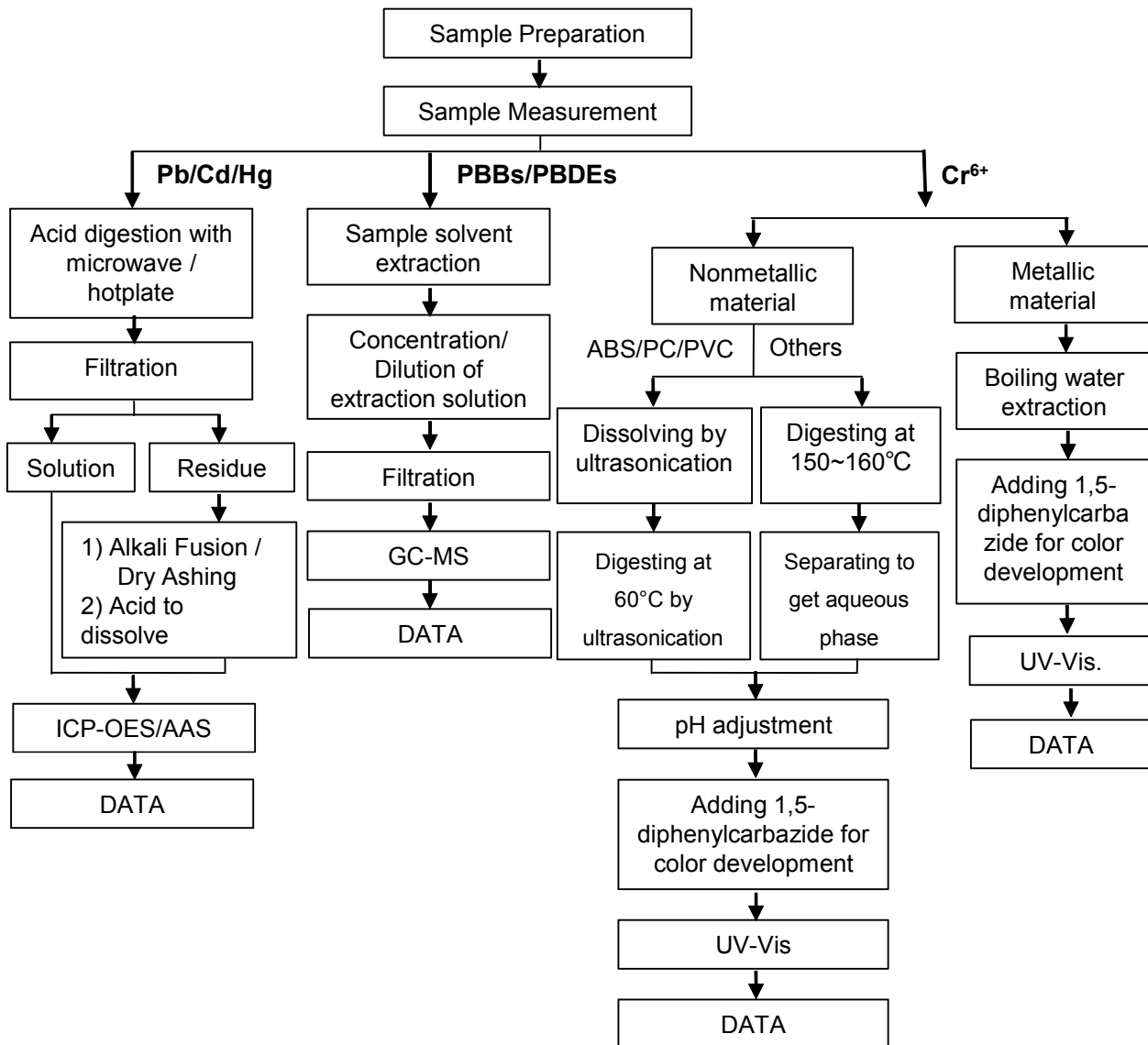

ATTACHMENTS

Phthalates Testing Flow Chart

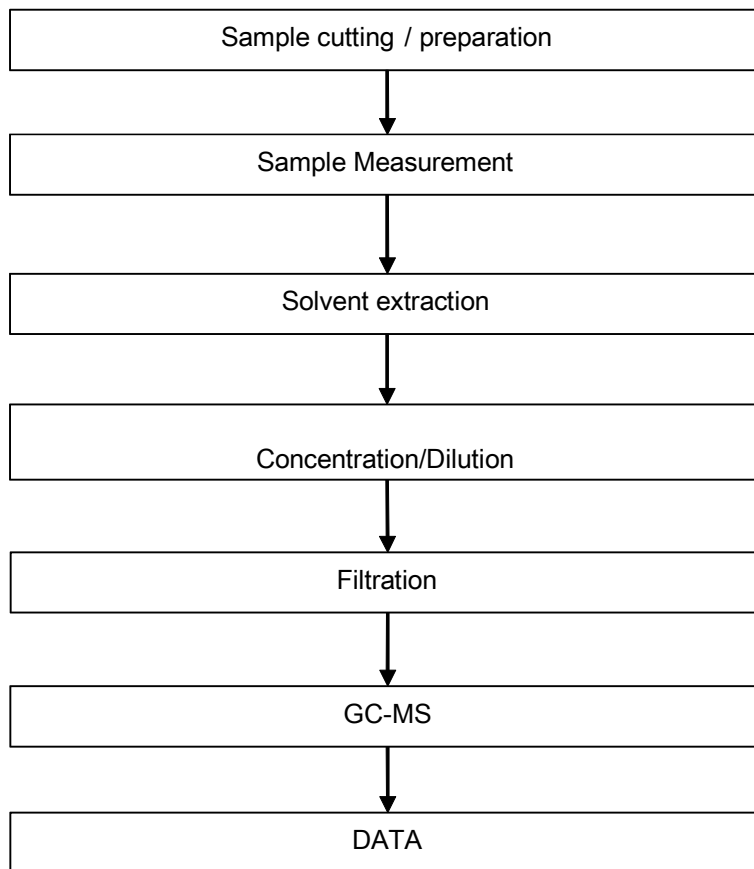

Unless otherwise agreed in writing, this document is issued by the Company subject to its General Conditions of Service printed overleaf, available on request or accessible at <http://www.sgs.com/en/Terms-and-Conditions.aspx> and, for electronic format documents, subject to Terms and Conditions for Electronic Documents at <http://www.sgs.com/en/Terms-and-Conditions/Terms-e-Document.aspx>. Attention is drawn to the limitation of liability, indemnification and jurisdiction issues defined therein. Any holder of this document is advised that information contained hereon reflects the Company's findings at the time of its intervention only and within the limits of Client's instructions, if any. The Company's sole responsibility is to its Client and this document does not exonerate parties to a transaction from exercising all their rights and obligations under the transaction documents. This document cannot be reproduced except in full, without prior written approval of the Company. Any unauthorized alteration, forgery or falsification of the content or appearance of this document is unlawful and offenders may be prosecuted to the fullest extent of the law. Unless otherwise stated the results shown in this test report refer only to the sample(s) tested.

Attention: To check the authenticity of testing / inspection report & certificate, please contact us at telephone: (86-755) 8307 1443, or email: CN_Doccheck@sgs.com

ATTACHMENTS

PFOA / PFOS Testing Flow Chart

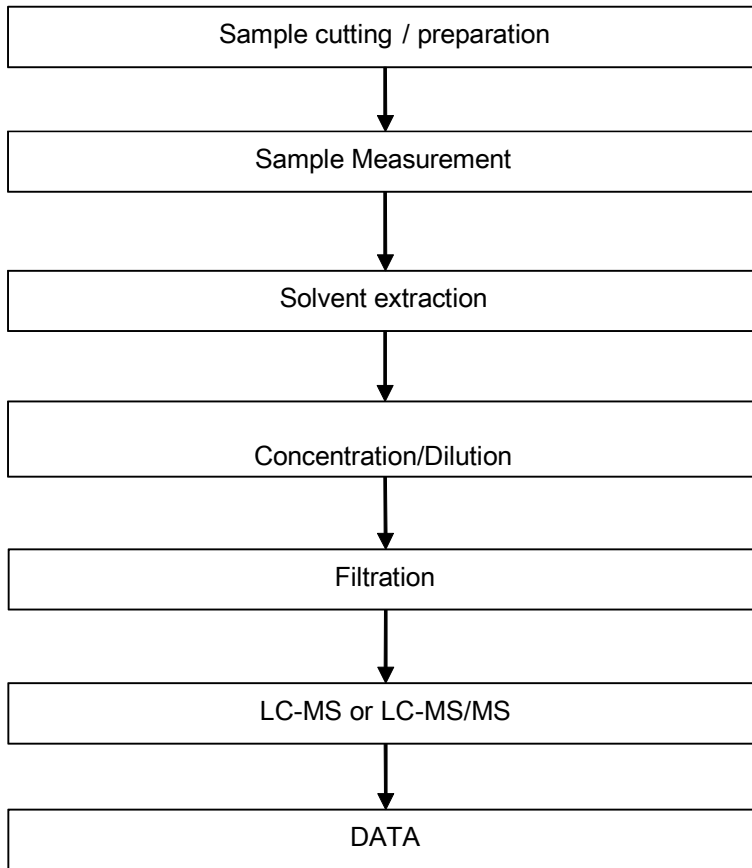

Unless otherwise agreed in writing, this document is issued by the Company subject to its General Conditions of Service printed overleaf, available on request or accessible at <http://www.sgs.com/en/Terms-and-Conditions.aspx> and, for electronic format documents, subject to Terms and Conditions for Electronic Documents at <http://www.sgs.com/en/Terms-and-Conditions/Terms-e-Document.aspx>. Attention is drawn to the limitation of liability, indemnification and jurisdiction issues defined therein. Any holder of this document is advised that information contained hereon reflects the Company's findings at the time of its intervention only and within the limits of Client's instructions, if any. The Company's sole responsibility is to its Client and this document does not exonerate parties to a transaction from exercising all their rights and obligations under the transaction documents. This document cannot be reproduced except in full, without prior written approval of the Company. Any unauthorized alteration, forgery or falsification of the content or appearance of this document is unlawful and offenders may be prosecuted to the fullest extent of the law. Unless otherwise stated the results shown in this test report refer only to the sample(s) tested.

Attention: To check the authenticity of testing / inspection report & certificate, please contact us at telephone: (86-755) 8307 1443, or email: CN_Doccheck@sgs.com

Sample photo:



SGS authenticate the photo on original report only

*** End of Report ***



Test Report

No. CANEC2117633803

Date: 27 Sep 2021

Page 1 of 8

SHENZHEN CITY TONGHUA INDUSTRY CO.,LTD

TONGHUA MANSIN TONGLE XINBU VILLANG TOWN SHENZHEN CITY CHINA

The following sample(s) was/were submitted and identified on behalf of the clients as : Nickel(Ni)

SGS Job No. : CP21-051017 - SZ

Date of Sample Received : 18 Sep 2021

Testing Period : 18 Sep 2021 - 27 Sep 2021

Test Requested : Selected test(s) as requested by client.

Test Method : Please refer to next page(s).

Test Results : Please refer to next page(s).

Conclusion : Based on the performed tests on submitted sample(s), the results of Lead, Mercury, Cadmium, Hexavalent chromium, Polybrominated biphenyls (PBBs), Polybrominated diphenyl ethers (PBDEs) and Phthalates such as Bis(2-ethylhexyl) phthalate (DEHP) , Butyl benzyl phthalate (BBP), Dibutyl phthalate (DBP) , and Diisobutyl phthalate (DIBP) comply with the limits as set by RoHS Directive (EU) 2015/863 amending Annex II to Directive 2011/65/EU.

Signed for and on behalf of
SGS-CSTC Standards Technical Services Co., Ltd. Guangzhou Branch

Allie Chen

Allie Chen
Approved Signatory

scan to see the report



CANEC2117633803



SGS-CSTC Standards Technical Services Co., Ltd.
Guangzhou Branch Testing Center Chemical Laboratory.

Unless otherwise agreed in writing, this document is issued by the Company subject to its General Conditions of Service printed overleaf, available on request or accessible at <http://www.sgs.com/en/Terms-and-Conditions.aspx> and, for electronic format documents, subject to Terms and Conditions for Electronic Documents at <http://www.sgs.com/en/Terms-and-Conditions/Terms-e-Document.aspx>. Attention is drawn to the limitation of liability, indemnification and jurisdiction issues defined therein. Any holder of this document is advised that information contained hereon reflects the Company's findings at the time of its intervention only and within the limits of Client's instructions, if any. The Company's sole responsibility is to its Client and this document does not exonerate parties to a transaction from exercising all their rights and obligations under the transaction documents. This document cannot be reproduced except in full, without prior written approval of the Company. Any unauthorized alteration, forgery or falsification of the content or appearance of this document is unlawful and offenders may be prosecuted to the fullest extent of the law. Unless otherwise stated the results shown in this test report refer only to the sample(s) tested.

Attention: To check the authenticity of testing /inspection report & certificate, please contact us at telephone: (86-755) 8307 1443, or email: CN.Doccheck@sgs.com

198 Kazhu Road, Sciotech Park Guangzhou Economic & Technology Development District, Guangzhou, China 510663

中国·广州·经济技术开发区科学城科珠路198号 邮编: 510663

t (86-20) 82155555 www.sgs.com

t (86-20) 82155555 sgs.china@sgs.com

Test Report

No. CANEC2117633803

Date: 27 Sep 2021

Page 2 of 8

Test Results :

Test Part Description :

Specimen No.	SGS Sample ID	Description
SN1	CAN21-176338.003	Silver-gray plated metal

Remarks :

- (1) 1 mg/kg = 1 ppm = 0.0001%
- (2) MDL = Method Detection Limit
- (3) ND = Not Detected (< MDL)
- (4) "-" = Not Regulated

RoHS Directive (EU) 2015/863 amending Annex II to Directive 2011/65/EU

Test Method : With reference to IEC 62321-4:2013+A1:2017, IEC 62321-5:2013, IEC 62321-7-1:2015 , IEC 62321-6:2015 and IEC 62321-8:2017, analyzed by ICP-OES , UV-Vis and GC-MS .

Test Item(s)	Limit	Unit	MDL	003
Cadmium (Cd)	100	mg/kg	2	ND
Lead (Pb)	1,000	mg/kg	2	37
Mercury (Hg)	1,000	mg/kg	2	ND
Hexavalent Chromium (Cr(VI))▼	-	µg/cm ²	0.10	ND
Sum of PBBs	1,000	mg/kg	-	ND
Monobromobiphenyl	-	mg/kg	5	ND
Dibromobiphenyl	-	mg/kg	5	ND
Tribromobiphenyl	-	mg/kg	5	ND
Tetrabromobiphenyl	-	mg/kg	5	ND
Pentabromobiphenyl	-	mg/kg	5	ND
Hexabromobiphenyl	-	mg/kg	5	ND
Heptabromobiphenyl	-	mg/kg	5	ND
Octabromobiphenyl	-	mg/kg	5	ND
Nonabromobiphenyl	-	mg/kg	5	ND
Decabromobiphenyl	-	mg/kg	5	ND
Sum of PBDEs	1,000	mg/kg	-	ND
Monobromodiphenyl ether	-	mg/kg	5	ND
Dibromodiphenyl ether	-	mg/kg	5	ND
Tribromodiphenyl ether	-	mg/kg	5	ND
Tetrabromodiphenyl ether	-	mg/kg	5	ND
Pentabromodiphenyl ether	-	mg/kg	5	ND



Unless otherwise agreed in writing, this document is issued by the Company subject to its General Conditions of Service printed overleaf, available on request or accessible at <http://www.sgs.com/en/Terms-and-Conditions.aspx> and, for electronic format documents, subject to Terms and Conditions for Electronic Documents at <http://www.sgs.com/en/Terms-and-Conditions/Terms-e-Documents.aspx>. Attention is drawn to the limitation of liability, indemnification and jurisdiction issues defined therein. Any holder of this document is advised that information contained hereon reflects the Company's findings at the time of its intervention only and within the limits of Client's instructions, if any. The Company's sole responsibility is to its Client and this document does not exonerate parties to a transaction from exercising all their rights and obligations under the transaction documents. This document cannot be reproduced except in full, without prior written approval of the Company. Any unauthorized alteration, forgery or falsification of the content or appearance of this document is unlawful and offenders may be prosecuted to the fullest extent of the law. Unless otherwise stated the results shown in this test report refer only to the sample(s) tested.

Attention: To check the authenticity of testing / inspection report & certificate, please contact us at telephone: (86-755) 8307 1443, or email: CN.Doccheck@sgs.com

Test Report

No. CANEC2117633803

Date: 27 Sep 2021

Page 3 of 8

<u>Test Item(s)</u>	<u>Limit</u>	<u>Unit</u>	<u>MDL</u>	<u>003</u>
Hexabromodiphenyl ether	-	mg/kg	5	ND
Heptabromodiphenyl ether	-	mg/kg	5	ND
Octabromodiphenyl ether	-	mg/kg	5	ND
Nonabromodiphenyl ether	-	mg/kg	5	ND
Decabromodiphenyl ether	-	mg/kg	5	ND
Dibutyl phthalate (DBP)	1000	mg/kg	50	ND
Butyl benzyl phthalate (BBP)	1000	mg/kg	50	ND
Bis (2-ethylhexyl) phthalate (DEHP)	1000	mg/kg	50	ND
Diisobutyl Phthalates (DIBP)	1000	mg/kg	50	ND

Notes :

- (1) The maximum permissible limit is quoted from RoHS Directive (EU) 2015/863.
- (2) IEC 62321 series is equivalent to EN 62321 series
https://www.cenelec.eu/dyn/www/f?p=104:30:1742232870351101:::FSP_ORG_ID,FSP_LANG_ID:1258637,25
- (3) ▼ = a. The sample is positive for CrVI if the CrVI concentration is greater than 0.13 µg/cm². The sample coating is considered to contain CrVI
 b. The sample is negative for CrVI if CrVI is ND (concentration less than 0.10 µg/cm²). The coating is considered a non-CrVI based coating
 c. The result between 0.10 µg/cm² and 0.13 µg/cm² is considered to be inconclusive - unavoidable coating variations may influence the determination
 Information on storage conditions and production date of the tested sample is unavailable and thus Cr(VI) results represent status of the sample at the time of testing.

Perfluorooctanoic acid (PFOA) and its salts & Perfluorooctane sulfonates (PFOS) and its derivatives

Test Method : With reference to CEN/TS15968:2010, analysis was performed by LC-MS or LC-MS/MS.

<u>Test Item(s)</u>	<u>CAS NO.</u>	<u>Unit</u>	<u>MDL</u>	<u>003</u>
Perfluorooctanoic acid (PFOA) and its salts+	335-67-1	mg/kg	0.010	ND
Perfluorooctane sulfonates (PFOS) ^	1763-23-1	mg/kg	0.010	ND
Perfluorooctane Sulfonamide (PFOSA)	754-91-6	mg/kg	0.010	ND
N-methylperfluoro-1-octanesulfonamide(MeFOSA)	31506-32-8	mg/kg	0.010	ND
N-ethylperfluoro-1-octanesulfonamide (EtFOSA)	4151-50-2	mg/kg	0.010	ND
2-(N-methylperfluoro-1-octanesulfonamido)-ethanol(MeFOSE)	24448-09-7	mg/kg	0.010	ND
2-(N-ethylperfluoro-1-octanesulfonamido)-ethanol(EtFOSE)	1691-99-2	mg/kg	0.010	ND
Perfluorooctane sulfonates (PFOS) and its derivatives	-	mg/kg	-	ND



Unless otherwise agreed in writing, this document is issued by the Company subject to its General Conditions of Service printed overleaf, available on request or accessible at <http://www.sgs.com/en/Terms-and-Conditions.aspx> and, for electronic format documents, subject to Terms and Conditions for Electronic Documents at <http://www.sgs.com/en/Terms-and-Conditions/Terms-e-Document.aspx>. Attention is drawn to the limitation of liability, indemnification and jurisdiction issues defined therein. Any holder of this document is advised that information contained hereon reflects the Company's findings at the time of its intervention only and within the limits of Client's instructions, if any. The Company's sole responsibility is to its Client and this document does not exonerate parties to a transaction from exercising all their rights and obligations under the transaction documents. This document cannot be reproduced except in full, without prior written approval of the Company. Any unauthorized alteration, forgery or falsification of the content or appearance of this document is unlawful and offenders may be prosecuted to the fullest extent of the law. Unless otherwise stated the results shown in this test report refer only to the sample(s) tested.

Notes :

- (1) + PFOA and its salts including PFOA-Na (CAS No.: 335-95-5), PFOA-K (CAS No.: 2395-00-8), PFOA-Ag (CAS No.: 335-93-3), PFOA-F (CAS No.: 335-66-0) and APFO (CAS No.: 3825-26-1);
- (2) ^ PFOS including PFOS-K (CAS No.: 2795-39-3), PFOS-Li (CAS No.: 29457-72-5), PFOS-NH₄ (CAS No.: 29081-56-9), PFOS-NH(OH)₂ (CAS No.: 70225-14-8), PFOS-N(C₂H₅)₄ (CAS No.: 56773-42-3), PFOS-DDA(CAS No.:251099-16-8) and POSF (CAS No.: 307-35-7)



Unless otherwise agreed in writing, this document is issued by the Company subject to its General Conditions of Service printed overleaf, available on request or accessible at <http://www.sgs.com/en/Terms-and-Conditions.aspx> and, for electronic format documents, subject to Terms and Conditions for Electronic Documents at <http://www.sgs.com/en/Terms-and-Conditions/Terms-e-Documents.aspx>. Attention is drawn to the limitation of liability, indemnification and jurisdiction issues defined therein. Any holder of this document is advised that information contained hereon reflects the Company's findings at the time of its intervention only and within the limits of Client's instructions, if any. The Company's sole responsibility is to its Client and this document does not exonerate parties to a transaction from exercising all their rights and obligations under the transaction documents. This document cannot be reproduced except in full, without prior written approval of the Company. Any unauthorized alteration, forgery or falsification of the content or appearance of this document is unlawful and offenders may be prosecuted to the fullest extent of the law. Unless otherwise stated the results shown in this test report refer only to the sample(s) tested.

Attention: To check the authenticity of testing / inspection report & certificate, please contact us at telephone: (86-755) 8307 1443, or email: CN.Doccheck@sgs.com

ATTACHMENTS

Pb/Cd/Hg/Cr⁶⁺/PBBs/PBDEs Testing Flow Chart

1) These samples were dissolved totally by pre-conditioning method according to below flow chart. (Cr⁶⁺ and PBBs/PBDEs test method excluded).

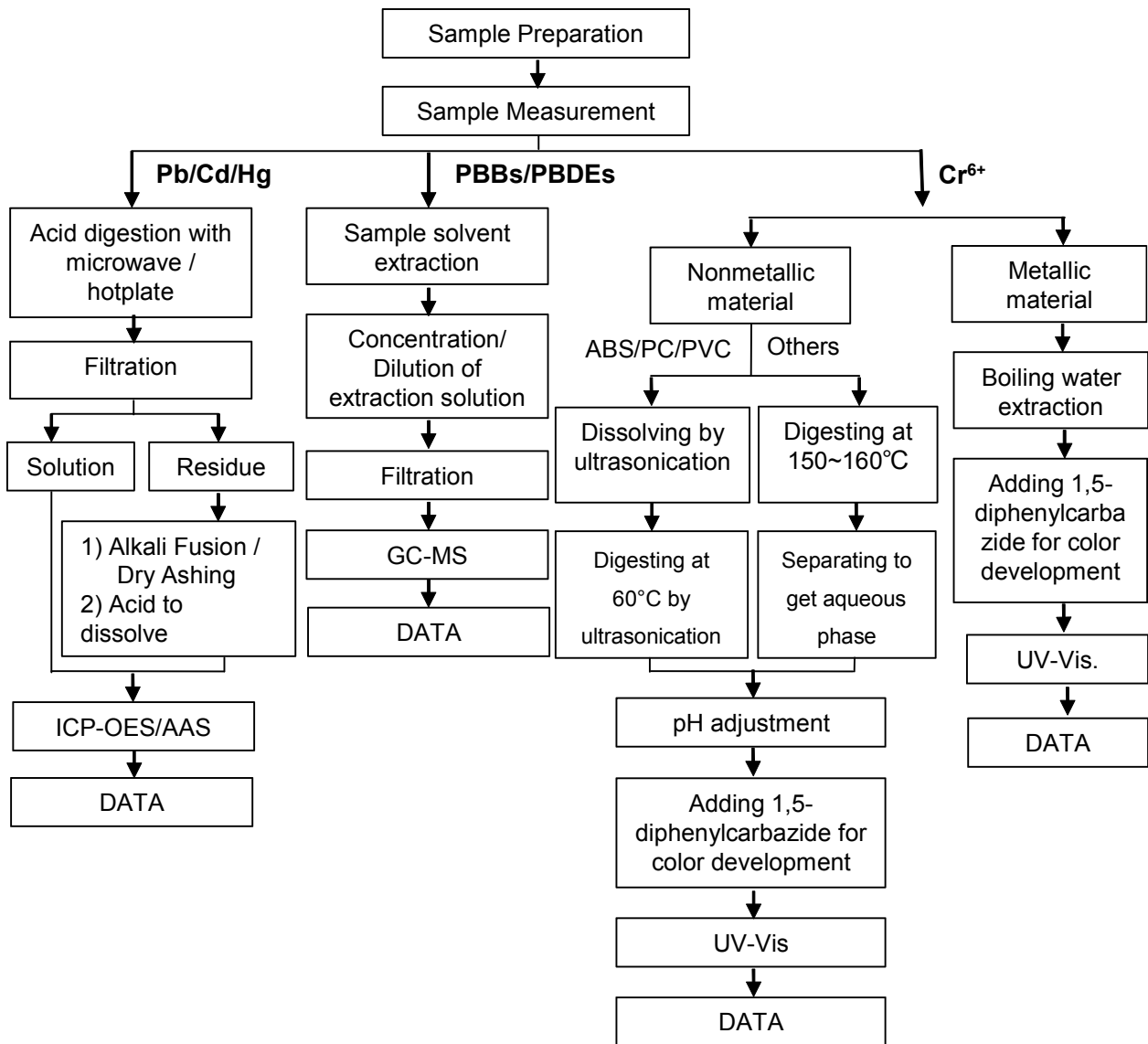

ATTACHMENTS

Phthalates Testing Flow Chart

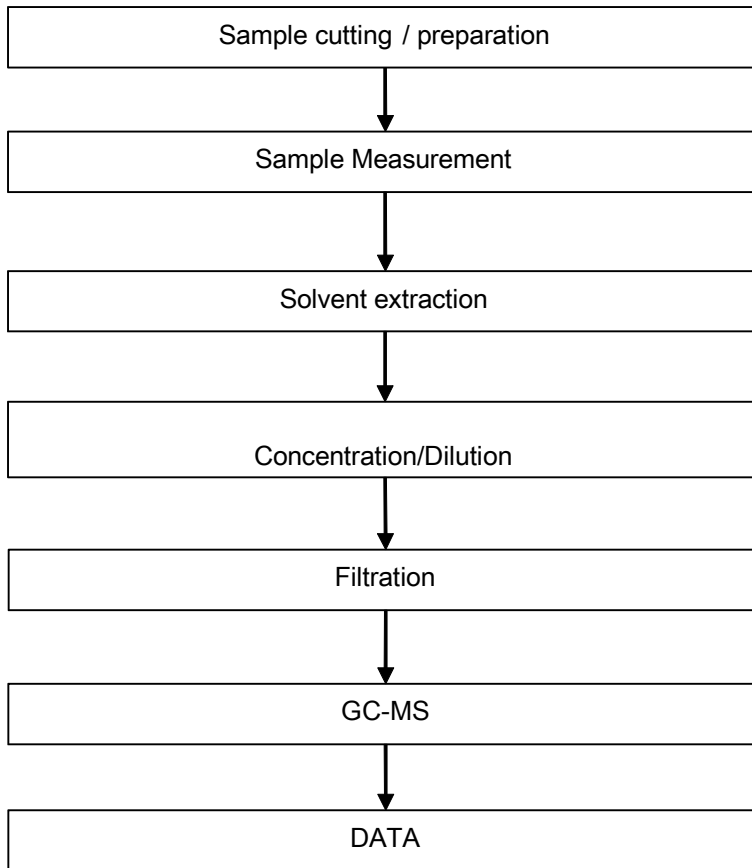

Unless otherwise agreed in writing, this document is issued by the Company subject to its General Conditions of Service printed overleaf, available on request or accessible at <http://www.sgs.com/en/Terms-and-Conditions.aspx> and, for electronic format documents, subject to Terms and Conditions for Electronic Documents at <http://www.sgs.com/en/Terms-and-Conditions/Terms-e-Document.aspx>. Attention is drawn to the limitation of liability, indemnification and jurisdiction issues defined therein. Any holder of this document is advised that information contained hereon reflects the Company's findings at the time of its intervention only and within the limits of Client's instructions, if any. The Company's sole responsibility is to its Client and this document does not exonerate parties to a transaction from exercising all their rights and obligations under the transaction documents. This document cannot be reproduced except in full, without prior written approval of the Company. Any unauthorized alteration, forgery or falsification of the content or appearance of this document is unlawful and offenders may be prosecuted to the fullest extent of the law. Unless otherwise stated the results shown in this test report refer only to the sample(s) tested.

Attention: To check the authenticity of testing / inspection report & certificate, please contact us at telephone: (86-755) 8307 1443, or email: CN_Doccheck@sgs.com

ATTACHMENTS

PFOA / PFOS Testing Flow Chart

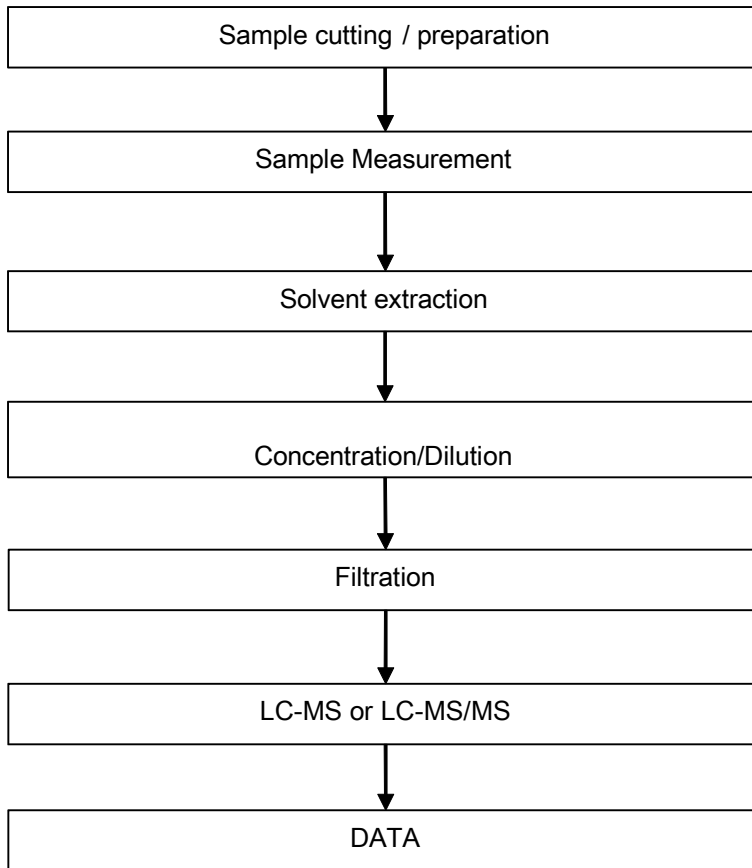

Unless otherwise agreed in writing, this document is issued by the Company subject to its General Conditions of Service printed overleaf, available on request or accessible at <http://www.sgs.com/en/Terms-and-Conditions.aspx> and, for electronic format documents, subject to Terms and Conditions for Electronic Documents at <http://www.sgs.com/en/Terms-and-Conditions/Terms-e-Document.aspx>. Attention is drawn to the limitation of liability, indemnification and jurisdiction issues defined therein. Any holder of this document is advised that information contained hereon reflects the Company's findings at the time of its intervention only and within the limits of Client's instructions, if any. The Company's sole responsibility is to its Client and this document does not exonerate parties to a transaction from exercising all their rights and obligations under the transaction documents. This document cannot be reproduced except in full, without prior written approval of the Company. Any unauthorized alteration, forgery or falsification of the content or appearance of this document is unlawful and offenders may be prosecuted to the fullest extent of the law. Unless otherwise stated the results shown in this test report refer only to the sample(s) tested.

Attention: To check the authenticity of testing / inspection report & certificate, please contact us at telephone: (86-755) 8307 1443, or email: CN_Doccheck@sgs.com

Sample photo:



SGS authenticate the photo on original report only

*** End of Report ***



Test Report

No. CANEC2117633802

Date: 27 Sep 2021

Page 1 of 8

SHENZHEN CITY TONGHUA INDUSTRY CO.,LTD

TONGHUA MANSIN TONGLE XINBU VILLANG TOWN SHENZHEN CITY CHINA

The following sample(s) was/were submitted and identified on behalf of the clients as : Bright Tin(SN)

SGS Job No. : CP21-051017 - SZ

Date of Sample Received : 18 Sep 2021

Testing Period : 18 Sep 2021 - 27 Sep 2021

Test Requested : Selected test(s) as requested by client.

Test Method : Please refer to next page(s).

Test Results : Please refer to next page(s).

Conclusion : Based on the performed tests on submitted sample(s), the results of Lead, Mercury, Cadmium, Hexavalent chromium, Polybrominated biphenyls (PBBs), Polybrominated diphenyl ethers (PBDEs) and Phthalates such as Bis(2-ethylhexyl) phthalate (DEHP) , Butyl benzyl phthalate (BBP), Dibutyl phthalate (DBP) , and Diisobutyl phthalate (DIBP) comply with the limits as set by RoHS Directive (EU) 2015/863 amending Annex II to Directive 2011/65/EU.

Signed for and on behalf of
SGS-CSTC Standards Technical Services Co., Ltd. Guangzhou Branch

Allie Chen

Allie Chen
Approved Signatory

scan to see the report



CANEC2117633802



SGS-CSTC Standards Technical Services Co., Ltd.
Guangzhou Branch Testing Center Chemical Laboratory.

Unless otherwise agreed in writing, this document is issued by the Company subject to its General Conditions of Service printed overleaf, available on request or accessible at <http://www.sgs.com/en/Terms-and-Conditions.aspx> and, for electronic format documents, subject to Terms and Conditions for Electronic Documents at <http://www.sgs.com/en/Terms-and-Conditions/Terms-e-Documents.aspx>. Attention is drawn to the limitation of liability, indemnification and jurisdiction issues defined therein. Any holder of this document is advised that information contained hereon reflects the Company's findings at the time of its intervention only and within the limits of Client's instructions, if any. The Company's sole responsibility is to its Client and this document does not exonerate parties to a transaction from exercising all their rights and obligations under the transaction documents. This document cannot be reproduced except in full, without prior written approval of the Company. Any unauthorized alteration, forgery or falsification of the content or appearance of this document is unlawful and offenders may be prosecuted to the fullest extent of the law. Unless otherwise stated the results shown in this test report refer only to the sample(s) tested.

Attention: To check the authenticity of testing /inspection report & certificate, please contact us at telephone: (86-755) 8307 1443, or email: CN.Doccheck@sgs.com

198 Kazhu Road, Sciotech Park Guangzhou Economic & Technology Development District, Guangzhou, China 510663
中国·广州·经济技术开发区科学城科珠路198号 邮编: 510663

t (86-20) 82155555 www.sgs.com
t (86-20) 82155555 sgs.china@sgs.com

Test Report

No. CANEC2117633802

Date: 27 Sep 2021

Page 2 of 8

Test Results :

Test Part Description :

Specimen No.	SGS Sample ID	Description
SN1	CAN21-176338.002	Silver-gray plated metal

Remarks :

- (1) 1 mg/kg = 1 ppm = 0.0001%
- (2) MDL = Method Detection Limit
- (3) ND = Not Detected (< MDL)
- (4) "-" = Not Regulated

RoHS Directive (EU) 2015/863 amending Annex II to Directive 2011/65/EU

Test Method : With reference to IEC 62321-4:2013+A1:2017, IEC 62321-5:2013, IEC 62321-7-1:2015 , IEC 62321-6:2015 and IEC 62321-8:2017, analyzed by ICP-OES , UV-Vis and GC-MS .

Test Item(s)	Limit	Unit	MDL	002
Cadmium (Cd)	100	mg/kg	2	ND
Lead (Pb)	1,000	mg/kg	2	29
Mercury (Hg)	1,000	mg/kg	2	ND
Hexavalent Chromium (Cr(VI))▼	-	µg/cm ²	0.10	ND
Sum of PBBs	1,000	mg/kg	-	ND
Monobromobiphenyl	-	mg/kg	5	ND
Dibromobiphenyl	-	mg/kg	5	ND
Tribromobiphenyl	-	mg/kg	5	ND
Tetrabromobiphenyl	-	mg/kg	5	ND
Pentabromobiphenyl	-	mg/kg	5	ND
Hexabromobiphenyl	-	mg/kg	5	ND
Heptabromobiphenyl	-	mg/kg	5	ND
Octabromobiphenyl	-	mg/kg	5	ND
Nonabromobiphenyl	-	mg/kg	5	ND
Decabromobiphenyl	-	mg/kg	5	ND
Sum of PBDEs	1,000	mg/kg	-	ND
Monobromodiphenyl ether	-	mg/kg	5	ND
Dibromodiphenyl ether	-	mg/kg	5	ND
Tribromodiphenyl ether	-	mg/kg	5	ND
Tetrabromodiphenyl ether	-	mg/kg	5	ND
Pentabromodiphenyl ether	-	mg/kg	5	ND



Unless otherwise agreed in writing, this document is issued by the Company subject to its General Conditions of Service printed overleaf, available on request or accessible at <http://www.sgs.com/en/Terms-and-Conditions.aspx> and, for electronic format documents, subject to Terms and Conditions for Electronic Documents at <http://www.sgs.com/en/Terms-and-Conditions/Terms-e-Documents.aspx>. Attention is drawn to the limitation of liability, indemnification and jurisdiction issues defined therein. Any holder of this document is advised that information contained hereon reflects the Company's findings at the time of its intervention only and within the limits of Client's instructions, if any. The Company's sole responsibility is to its Client and this document does not exonerate parties to a transaction from exercising all their rights and obligations under the transaction documents. This document cannot be reproduced except in full, without prior written approval of the Company. Any unauthorized alteration, forgery or falsification of the content or appearance of this document is unlawful and offenders may be prosecuted to the fullest extent of the law. Unless otherwise stated the results shown in this test report refer only to the sample(s) tested.

Attention: To check the authenticity of testing / inspection report & certificate, please contact us at telephone: (86-755) 8307 1443, or email: CN.Doccheck@sgs.com

Test Report

No. CANEC2117633802

Date: 27 Sep 2021

Page 3 of 8

<u>Test Item(s)</u>	<u>Limit</u>	<u>Unit</u>	<u>MDL</u>	<u>002</u>
Hexabromodiphenyl ether	-	mg/kg	5	ND
Heptabromodiphenyl ether	-	mg/kg	5	ND
Octabromodiphenyl ether	-	mg/kg	5	ND
Nonabromodiphenyl ether	-	mg/kg	5	ND
Decabromodiphenyl ether	-	mg/kg	5	ND
Dibutyl phthalate (DBP)	1000	mg/kg	50	ND
Butyl benzyl phthalate (BBP)	1000	mg/kg	50	ND
Bis (2-ethylhexyl) phthalate (DEHP)	1000	mg/kg	50	ND
Diisobutyl Phthalates (DIBP)	1000	mg/kg	50	ND

Notes :

- (1) The maximum permissible limit is quoted from RoHS Directive (EU) 2015/863.
- (2) IEC 62321 series is equivalent to EN 62321 series
https://www.cenelec.eu/dyn/www/f?p=104:30:1742232870351101:::FSP_ORG_ID,FSP_LANG_ID:1258637,25
- (3) ▼ = a. The sample is positive for CrVI if the CrVI concentration is greater than 0.13 µg/cm². The sample coating is considered to contain CrVI
 b. The sample is negative for CrVI if CrVI is ND (concentration less than 0.10 µg/cm²). The coating is considered a non-CrVI based coating
 c. The result between 0.10 µg/cm² and 0.13 µg/cm² is considered to be inconclusive - unavoidable coating variations may influence the determination
 Information on storage conditions and production date of the tested sample is unavailable and thus Cr(VI) results represent status of the sample at the time of testing.

Perfluorooctanoic acid (PFOA) and its salts & Perfluorooctane sulfonates (PFOS) and its derivatives

Test Method : With reference to CEN/TS15968:2010, analysis was performed by LC-MS or LC-MS/MS.

<u>Test Item(s)</u>	<u>CAS NO.</u>	<u>Unit</u>	<u>MDL</u>	<u>002</u>
Perfluorooctanoic acid (PFOA) and its salts+	335-67-1	mg/kg	0.010	ND
Perfluorooctane sulfonates (PFOS) ^	1763-23-1	mg/kg	0.010	ND
Perfluorooctane Sulfonamide (PFOSA)	754-91-6	mg/kg	0.010	ND
N-methylperfluoro-1-octanesulfonamide(MeFOSA)	31506-32-8	mg/kg	0.010	ND
N-ethylperfluoro-1-octanesulfonamide (EtFOSA)	4151-50-2	mg/kg	0.010	ND
2-(N-methylperfluoro-1-octanesulfonamido)-ethanol(MeFOSE)	24448-09-7	mg/kg	0.010	ND
2-(N-ethylperfluoro-1-octanesulfonamido)-ethanol(EtFOSE)	1691-99-2	mg/kg	0.010	ND
Perfluorooctane sulfonates (PFOS) and its derivatives	-	mg/kg	-	ND



Unless otherwise agreed in writing, this document is issued by the Company subject to its General Conditions of Service printed overleaf, available on request or accessible at <http://www.sgs.com/en/Terms-and-Conditions.aspx> and, for electronic format documents, subject to Terms and Conditions for Electronic Documents at <http://www.sgs.com/en/Terms-and-Conditions/Terms-e-Documents.aspx>. Attention is drawn to the limitation of liability, indemnification and jurisdiction issues defined therein. Any holder of this document is advised that information contained hereon reflects the Company's findings at the time of its intervention only and within the limits of Client's instructions, if any. The Company's sole responsibility is to its Client and this document does not exonerate parties to a transaction from exercising all their rights and obligations under the transaction documents. This document cannot be reproduced except in full, without prior written approval of the Company. Any unauthorized alteration, forgery or falsification of the content or appearance of this document is unlawful and offenders may be prosecuted to the fullest extent of the law. Unless otherwise stated the results shown in this test report refer only to the sample(s) tested.

Attention: To check the authenticity of testing / inspection report & certificate, please contact us at telephone: (86-755) 8307 1443, or email: CN.Doccheck@sgs.com

Notes :

- (1) + PFOA and its salts including PFOA-Na (CAS No.: 335-95-5), PFOA-K (CAS No.: 2395-00-8), PFOA-Ag (CAS No.: 335-93-3), PFOA-F (CAS No.: 335-66-0) and APFO (CAS No.: 3825-26-1);
(2) ^ PFOS including PFOS-K (CAS No.: 2795-39-3), PFOS-Li (CAS No.: 29457-72-5), PFOS-NH₄ (CAS No.: 29081-56-9), PFOS-NH(OH)₂ (CAS No.: 70225-14-8), PFOS-N(C₂H₅)₄ (CAS No.: 56773-42-3), PFOS-DDA(CAS No.:251099-16-8) and POSF (CAS No.: 307-35-7)



Unless otherwise agreed in writing, this document is issued by the Company subject to its General Conditions of Service printed overleaf, available on request or accessible at <http://www.sgs.com/en/Terms-and-Conditions.aspx> and, for electronic format documents, subject to Terms and Conditions for Electronic Documents at <http://www.sgs.com/en/Terms-and-Conditions/Terms-e-Documents.aspx>. Attention is drawn to the limitation of liability, indemnification and jurisdiction issues defined therein. Any holder of this document is advised that information contained hereon reflects the Company's findings at the time of its intervention only and within the limits of Client's instructions, if any. The Company's sole responsibility is to its Client and this document does not exonerate parties to a transaction from exercising all their rights and obligations under the transaction documents. This document cannot be reproduced except in full, without prior written approval of the Company. Any unauthorized alteration, forgery or falsification of the content or appearance of this document is unlawful and offenders may be prosecuted to the fullest extent of the law. Unless otherwise stated the results shown in this test report refer only to the sample(s) tested.

Attention: To check the authenticity of testing / inspection report & certificate, please contact us at telephone: (86-755) 8307 1443, or email: CN.Doccheck@sgs.com

ATTACHMENTS

Pb/Cd/Hg/Cr⁶⁺/PBBs/PBDEs Testing Flow Chart

1) These samples were dissolved totally by pre-conditioning method according to below flow chart. (Cr⁶⁺ and PBBs/PBDEs test method excluded).

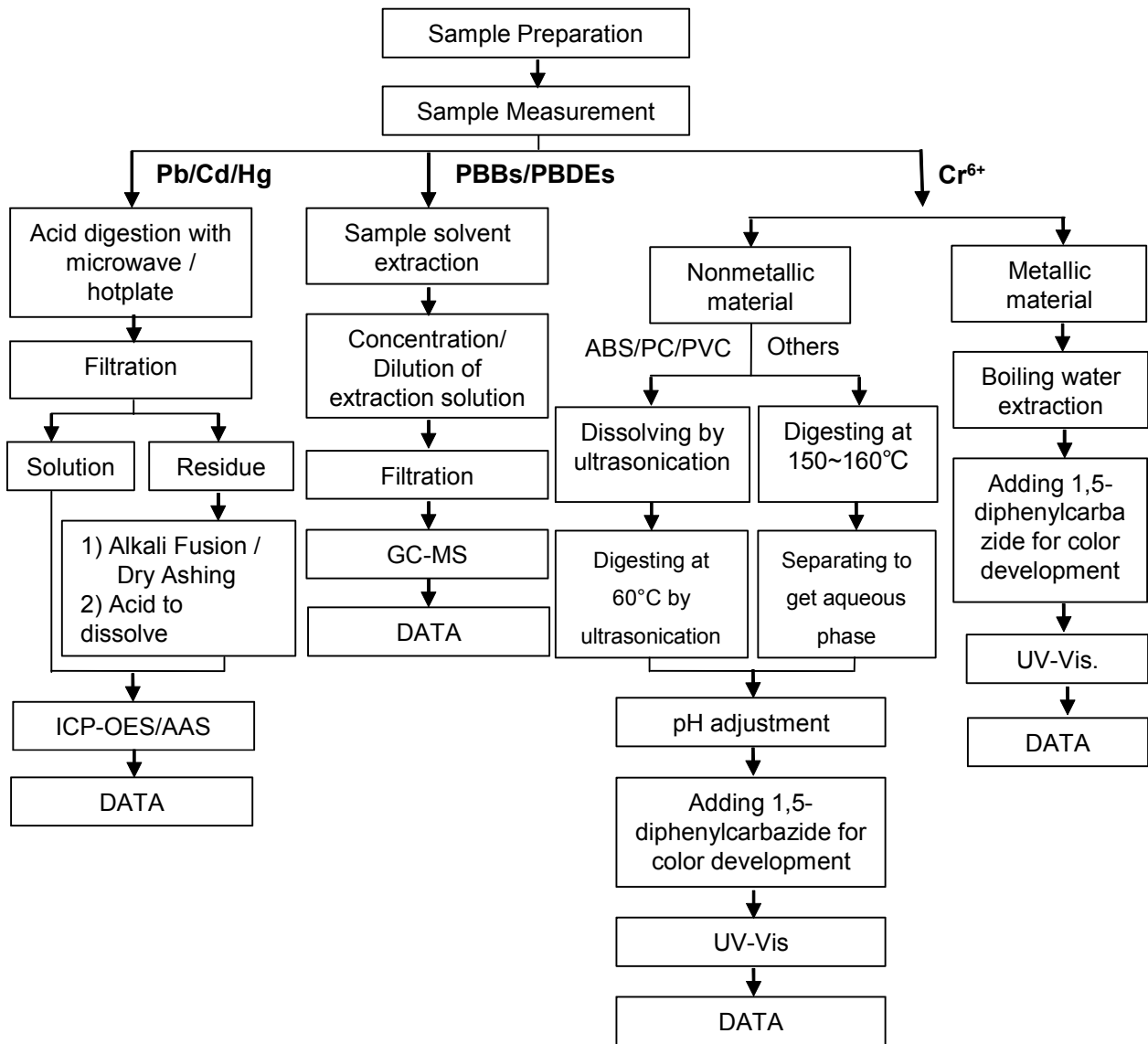

ATTACHMENTS

Phthalates Testing Flow Chart

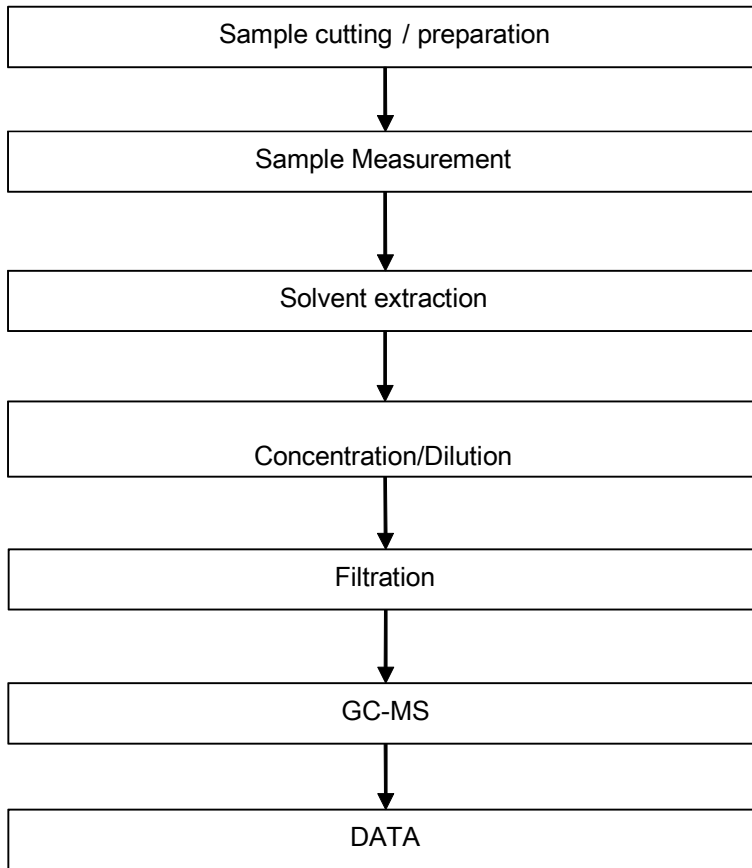

Unless otherwise agreed in writing, this document is issued by the Company subject to its General Conditions of Service printed overleaf, available on request or accessible at <http://www.sgs.com/en/Terms-and-Conditions.aspx> and, for electronic format documents, subject to Terms and Conditions for Electronic Documents at <http://www.sgs.com/en/Terms-and-Conditions/Terms-e-Document.aspx>. Attention is drawn to the limitation of liability, indemnification and jurisdiction issues defined therein. Any holder of this document is advised that information contained hereon reflects the Company's findings at the time of its intervention only and within the limits of Client's instructions, if any. The Company's sole responsibility is to its Client and this document does not exonerate parties to a transaction from exercising all their rights and obligations under the transaction documents. This document cannot be reproduced except in full, without prior written approval of the Company. Any unauthorized alteration, forgery or falsification of the content or appearance of this document is unlawful and offenders may be prosecuted to the fullest extent of the law. Unless otherwise stated the results shown in this test report refer only to the sample(s) tested.

Attention: To check the authenticity of testing / inspection report & certificate, please contact us at telephone: (86-755) 8307 1443, or email: CN.Doccheck@sgs.com

ATTACHMENTS

PFOA / PFOS Testing Flow Chart

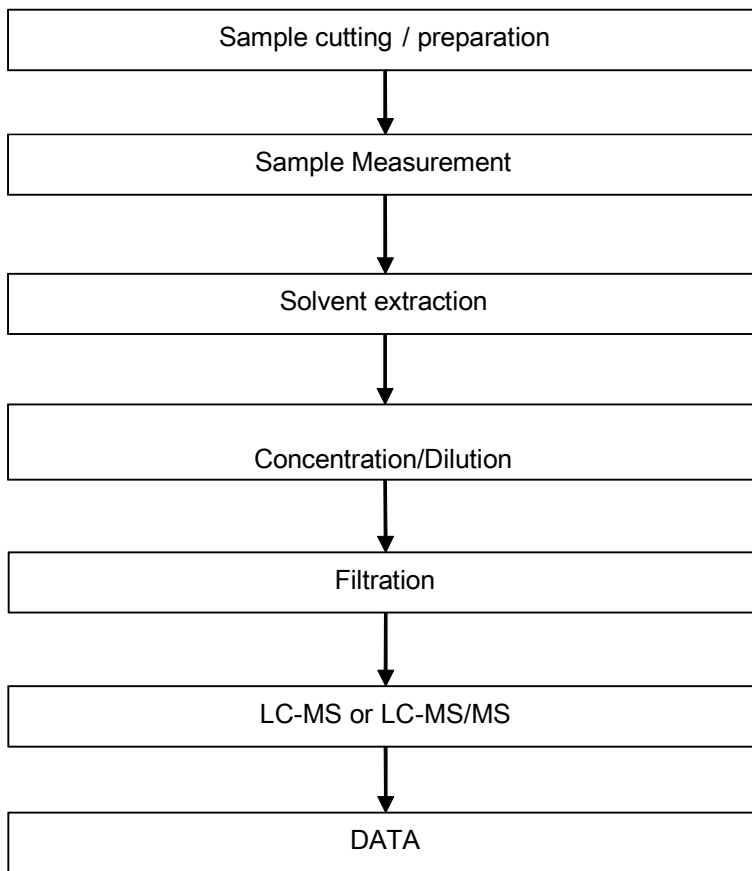

Unless otherwise agreed in writing, this document is issued by the Company subject to its General Conditions of Service printed overleaf, available on request or accessible at <http://www.sgs.com/en/Terms-and-Conditions.aspx> and, for electronic format documents, subject to Terms and Conditions for Electronic Documents at <http://www.sgs.com/en/Terms-and-Conditions/Terms-e-Document.aspx>. Attention is drawn to the limitation of liability, indemnification and jurisdiction issues defined therein. Any holder of this document is advised that information contained hereon reflects the Company's findings at the time of its intervention only and within the limits of Client's instructions, if any. The Company's sole responsibility is to its Client and this document does not exonerate parties to a transaction from exercising all their rights and obligations under the transaction documents. This document cannot be reproduced except in full, without prior written approval of the Company. Any unauthorized alteration, forgery or falsification of the content or appearance of this document is unlawful and offenders may be prosecuted to the fullest extent of the law. Unless otherwise stated the results shown in this test report refer only to the sample(s) tested.

Attention: To check the authenticity of testing / inspection report & certificate, please contact us at telephone: (86-755) 8307 1443, or email: CN_Doccheck@sgs.com

Sample photo:



SGS authenticate the photo on original report only

*** End of Report ***

