

承 认 书

Approval Sheet

客户 (Customer): /

客户料号 (Cus .P/N): /

华联威料号 (HLW P/N): ST21-0240-G618

品名规格 (PronameSpec): SATA 7+15P 长体双排长度 2.75

送样日期 (Delivery Date): 2022/06/09

承认日期 (Acknowledge Date): 2022/06/9

Approved No:		客 户 Customer	
采 购 部 Purchasing Dept	品 质 部 QC Dept	工 程 部 Engineering Dept	确 认 Approved By
深 圳 市 华 联 威 电 子 科 技 有 限 公 司 SHEN ZHEN SHI HUA LIAN WEI ELECTRONICS TECHNOLOGY CO; LTD.			
业 务 部 Sales Dept	品 管 部 QC Dept	工 程 部 Engineering Dept	核 准 Checked By
陈少萍	欠必锋	魏红	唐竹君

地址: 深圳市龙华区观澜街道桂香社区观澜桂花路 307 号

TEL: 0755-28888886 28888866

邮箱: hua@hlwconn.com

[Http://www.hlwconn.com](http://www.hlwconn.com)

目 录

Contents

图纸.....	Page03
产品规格书.....	Page04-07
产品检测报告.....	Page08-09
尺寸测试报告.....	Page10
电镀报告.....	Page11-12
盐雾报告.....	Page13
材质证明.....	Page14-15
SGS.....	Page16-49

REV.	ECN.NO.	APPD.
A	/	/

NOTE:

- MATERIAL:
HOUSING: LCP WITH 30% GF, UL 94V-0, BLACK COLOR.
CONTACTS: PHOSPHOR BRONZE.
BOARDLOCKS: BRASS.
- FINISH:
CONTACTS: GOLD FLASH PLATED ON CONTACT AREA, [100μ"] MIN..
BRIGHT-TIN ON SOLDER TAIL, WITH ENTIRE CONTACT UNDERPLATED [50μ"] MIN.. NICKEL.
BOARDLOCKS: [100μ"] MIN. BRIGHT-TIN OVER[50μ"] MIN. NICKEL ON ENTIRE BOARDLOCK.
- PART NUMBER DESCRIPTION :

ST21-0240-G618

G: 半金G/Fu"
6: LCP
1: 黑色

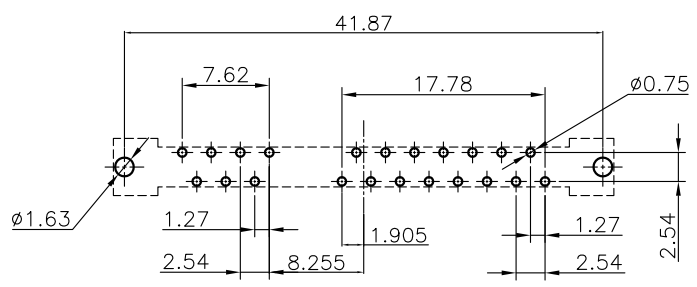
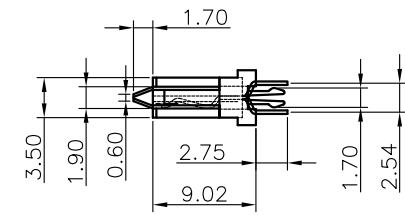
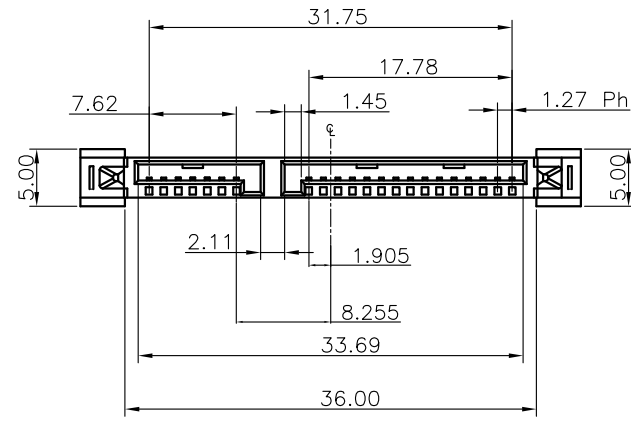
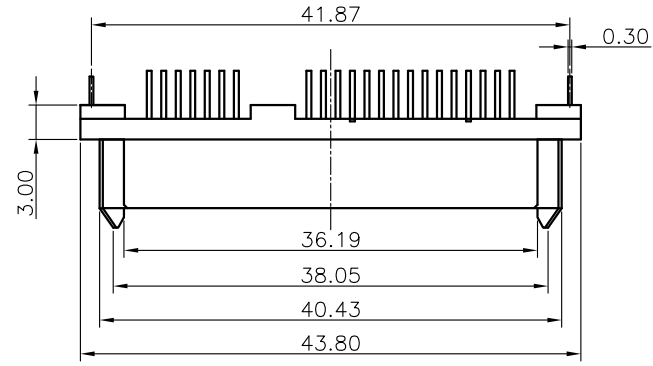

TOLERANCE: ±0.05,
RECOMMENDED PCB LAYOUT
(TOP VIEW)

TOLERANCE UNLESS OTHERWISE SPECIFIED		FLW 深圳市华联威电子科技有限公司			
.XXX ±0.10 .XX ±0.20 .X ±0.30		.X' ±3' .XX' ±2'		HUA LIAN WEI TECHNOLOGY ELECTRONICS CO;LTD.	
APPROVED		PART NAME:	SATA 7+15P 长体双排180度 PC2.75无凸鱼叉脚		
CHECKED		PART No:	ST21-0240-G618	C	
DRAWN	weihong	PROJECTION:	UNIT:	SCALE	SHEET
DATE	2021.9.23		mm	1:1	10F1
					REV. A

SATA系列產品SPEC

TEST ITEM		REQUIREMENT	PROCEDURE
1	Examination of Product	Meets requirements of product drawing. No physical damage.	Visual inspection.
2	Operating Temperature	-55°C to +125 °C	
3	Storage Temperature	-25°C to 85 °C	
ELECTRICAL REQUIREMENT			
4	Rating Voltage	30 V RMS max	
5	Contact current rating (Power segment)	1.5A per pin minimum The temperature rise above ambient shall not exceed 30°C at any point in the connector when contact positions are powered. The ambient condition is still air at 25°C.	Mount connector to a test PCB Wire three adjacent pins in parallel for supply (or the minimum number required by the connector type) Wire three adjacent pins in parallel for return (or the minimum number required by the connector type) Apply a DC current rating per contact to the supply pins returning through the return pins Record temperature rise when thermal equilibrium is reached
6	Contact Resistance	30 mΩ (initially) maximum, Δ15mΩ max after stress when measured at 20 mV maximum open circuit at 100 mA. Mated test contacts must be in a connector housing.	EIA 364-23 The object of this test is to detail a standard method to measure the electrical resistance across a pair of mated contacts such that the insulating films, if present, will not be broken or asperity melting will not occur.
7	Dielectric withstanding Voltage	The dielectric shall withstand 500VAC for 1 minute at sea level.	EIA 364-20 Method B Test between adjacent contacts of mated and unmated connector assemblies.

8	Insulation Resistance	1000 M Ω minimum	EIA 364-21 After 500 VDC for 1 minute measure the insulation resistance between the adjacent contacts of mated and unmated connector assemblies.
9	Temperature Rising	30°C Max. Under loaded rating current	Contact series-wired, apply test current of loaded rating current to the circuit, and measure the temperature rising by probing on soldered areas of contacts, after the temperature becomes stabilized deduct ambient temperature from the measured value.
Mechanical Requirement			
10	Connector Mating Force	45 N Max	EIA-364-13 Measure the force necessary to mated the connector assemblies at a max.rate of 12.5 mm per minute.
11	Connector Unmating Force	10 N Min.through 50cycles	EIA-364-13 Measure the force necessary to mate the connector assemblies at a max.rate of 12.5 mm per minute.
12	Durability	No physical damage. Meet requirements of additional tests as specified in the test sequence.	EIA-364-09 50 cycles for intemal cabled application; 500cycles for backplane/blindmate application. Test done at a maximum rate of 200 cycles per hour.

13	Vibration	No discontinuities of 1 us longer duration.	EIA364-28 Condition V Test letter A Subject mated connectors to 5.35 g's RMS. 30minutes in each of three mutually perpendicular planes. See NOTE 2.
14	Mechanical Shock	No discontinuities of 1 us or longer duration. No physical damage.	EIA 364-27 Condition H Subject mated connectors to 30 g's half-sine shock pulses of 11 ms duration applied along three mutually perpendicular planes for a total of 18 shocks. See NOTE 2.
15	Solder ability	contact solder tails must pass 95% coverage after one hour steam aging as specified.	1)Temperature of fused solder: 260+5°C. 2)Dipping time:5+0.5s EIA 364-52
Environmental Requirements			
16	Resistance to Solder Heat	Forming resin shall not be distorted, and terminations shall not be separated.	1) Depth of dipping termination: the distance between the mounting surface and solder surface shall be 1 mm to 2mm. 2)Temperature:260±5°C. 3) Dipping time: 10±1s Socket EIA 364-56
17	Thermal Shock	See NOTE .	EIA 364-32 Test Condition 1. Subject mated connectors to 10 cycles between -55°C and +85°C.
18	Humidity	See NOTE .	EIA 364-31 Method II Test Condition A Subject mated connectors to 96 hours at 40°C with 90% to 95% RH.
19	Temperature Life	See NOTE.	EIA 364-17 Test Condition III Method A. Subject mated connectors to temperature life at +85°C for 500 hours.

20	Salt Spray	Visual Inspection-No physical damageLLCR-50 mΩ max per contact	Mated connector expose to 5% salt concentration for 12 hours at temperature 35+2°C.After the test specimens shall be washed with running water and dried
----	------------	--	--

NOTE:

1. Shall meet EIA 364-18 Visual Examination requirements, show no physical damage, and shall meet requirements of additional tests as specified in the sequence.
- 2.Shock and vibration test fixture is to be determined by each user with connector vendors.

Test or Examination	Test Group									
	A	B	C	D	E	F	G	H	I	J
	Test Sequence (a)									
Examination of Product	1,5	1,9	1,7	1,8	1,5	1, 5	1, 3	1, 3	1, 3	
Contact Resistance	2,4	3,7	2,4,6		3,4	2, 4				
Insulation Resistance				2,6						
Dielectric withstanding				3,7						
Mating Force		2								
Unmating Force		8								
Durability	3	4			2					
Mechanical Shock		6								
Vibration		5								
Humidity Temperature				5						
Temperature Life			3							
Thermal Shock			5	4						
Temperature Rising							2			
Solderability									2	
Resistance to Soldering								2		
Salt Spray						3	3			
備注	無客戶指定增加測試項目外，依照此標準進行產品可靠性評估。									

核准：唐竹君

制作人：魏红

3	Gold test	Temperature: -25 ±3°C Duration:168H	PROGRAM CONTROLLED TEMP. & HUMIDTY CHAMBER	No physical damage	Pass	Pass	Pass	Pass	Pass	P	
4	Temperature cycling test	Temperature:85 ~-25°C Duration:5 cycle	PROGRAM CONTROLLED TEMP. & HUMIDTY CHAMBER	No physical damage	Pass	Pass	Pass	Pass	Pass	P	

四.物理測試 PHYSICAL TEST

序 號 NO.	測試項目 Testing Item	測試條件 Testing Conditions	測試設備 Testing Equipment	規格 SPEC	測試記錄 Testing Result					判定 Judge	
					1	2	3	4	5	Pass	Fail
1	Salt spray test	Temperature: 35±2°C Concentration:5±1 %Duration:12H	SALT SPRAY TESTER	No Oxidation	Pass	Pass	Pass	Pass	Pass	P	
2	Resistance to soldering heat test	Temperature: 260±5°C Duration:10±1sec	OVEN	No physical damage	Pass	Pass	Pass	Pass	Pass	P	
3	Solder ability test	Temperature: 260±5°C Duration:5±0.5 sec	CONTROLLED CONSTANT-TEMP SOLDER POT	Soldering area ≥95□	Pass	Pass	Pass	Pass	Pass	P	
判定 Result		<input checked="" type="checkbox"/> 合格 (ACCEPT) <input type="checkbox"/> 不合格 (REJECT)									

核准(Approver): 欠必峰

測試(Tester): 但芬

檢驗報告

首件檢驗
 入庫檢驗
 出貨檢驗
 客退檢驗
 退料檢驗
 其他

2022年06月08日 版次:A1

料號	ST21-0240-G618	制令單號	/					送檢單位	工程部	首件製作者	裝配		
品名	SATA 7+15P长体双 排长度2.75	客戶代號	/					批 量	/	送檢時間	/		
								數 量	5PCS	確認時間	/		
抽樣標準		<input checked="" type="checkbox"/> 單次 <input type="checkbox"/> 雙次					抽樣數 (5PCS)	AQL	CRI:0	MAJ:0.40	MIN:0.65		
MIL-STD-105E(II)		<input checked="" type="checkbox"/> 正常 <input type="checkbox"/> 加嚴 <input type="checkbox"/> 減量						ACC/REJ	0	/	/		
不良數: CRI (/) MAJ (/) MIN (/)								不良率(%)		/			
NO.	檢驗項目 單位:MM/G	檢測 儀器	檢 驗 記 錄					品管判定		CRI	MAJ	MIN	備注
			1	2	3	4	5	AC	RE				
尺 寸 測 量	41.87±0.20	D	41.85	41.82	41.84	41.85	41.84	✓					
	43.80±0.20	D	43.82	43.85	43.83	43.85	43.84	✓					
	31.75±0.20	D	31.74	31.72	31.71	31.72	31.74	✓					
	36.00±0.20	D	36.02	36.03	36.04	36.03	36.02	✓					
	1.27±0.20	D	1.28	1.26	1.25	1.26	1.28	✓					
	5.00±0.20	D	5.03	5.05	5.03	5.03	5.04	✓					
	17.78±0.20	D	17.82	17.85	17.83	17.82	17.83	✓					
檢驗依據: <input checked="" type="checkbox"/> 《工程圖紙》 <input type="checkbox"/> 《檢驗規範》 <input type="checkbox"/> 《承認書》 <input type="checkbox"/> 樣品 <input type="checkbox"/> 其它													
檢測儀器:A游標卡尺 B千分尺 C厚薄儀 D投影鏡 E放大鏡 F顯微鏡 G錫爐 H插拔力器 I問位尺 J其它													
品管判定:		<input checked="" type="checkbox"/> 合格Accept <input type="checkbox"/> 退貨Reject <input type="checkbox"/> 特采Waive <input type="checkbox"/> 挑選Sort											
核 准 APP		欠必鋒			審 核 CHK		/			檢 驗 員 INSPBY		但芬	

保存期限:三年

保存部門:品保部

QR-M-003

品名: SATA 7+15P 长体双排 (端子)				版次:A. 0	
电镀规格:Ni30u", Sn100u", Au G/Fu"			日期:2022-03-20		页次:1/1
厂商:同华					
测试设备:CMI X-射线膜厚测试仪					
1、底层电镀测试 (Ni)					
数据	测试标准	实测值	判定	测试日期	测试时间
1	30u"MIN	50.5u"	OK	2022/3/20	10:20:15
2	30u"MIN	56.3u"	OK	2022/3/20	10:20:17
3	30u"MIN	67.5u"	OK	2022/3/20	10:20:19
4	30u"MIN	62.4u"	OK	2022/3/20	10:20:21
2、表层电镀测试 (Sn)					
数据	测试标准	实测值	判定	测试日期	测试时间
1	100u"MIN	105.3u"	OK	2022/3/20	10:25:10
2	100u"MIN	104.7u"	OK	2022/3/20	10:25:12
3	100u"MIN	105.9u"	OK	2022/3/20	10:25:14
4	100u"MIN	107.4u"	OK	2022/3/20	10:25:16
3、表层电镀测试 (Au)					
数据	测试标准	实测值	判定	测试日期	测试时间
1	0.5u"MIN	0.52u"	OK	2022/3/20	10:30:32
2	0.5u"MIN	0.55u"	OK	2022/3/20	10:30:34
3	0.5u"MIN	0.53u"	OK	2022/3/20	10:30:36
4	0.5u"MIN	0.54u"	OK	2022/3/20	10:30:38

核准: 欠必锋

审核: 李娟

检验员: 但芬

电镀报告表

品名: SATA 7+15P 长体双排 (鱼叉脚)		版次:A. 0			
电镀规格:Ni:50u" min	日期:2022/3/16	页次:1/1			
厂商:金和源 测试设备:CMI X-射线膜厚测试仪 1、表层电镀测试 (Ni)					
数据	测试标准	实测值	判定	测试日期	测试时间
1	50u"min	56.3u"	OK	2022/3/16	10:42:14
2	50u"min	58.6u"	OK	2022/3/16	10:42:16
3	50u"min	55.4u"	OK	2022/3/16	10:42:18
4	50u"min	54.5u"	OK	2022/3/16	10:42:20

核准: 欠必锋

审核: 李娟

检验员: 但芬



深圳市华联威电子科技有限公司

盐水喷雾实验报告

试验方法	盐水喷雾腐蚀试验法	参考资料	MIL-STD-1345
METHOD	NEUTRL SALT SPRAY CORROSION TEST	REF	
客户		试验起始日期	2022年06月8日 20:00 时起
		DATE	2022年06月9日 08:00 时止
样品名称	SATA 7+15P 长体双排长度2.75	试验数量	5PCS
P/N	ST21-0240-G618	QTY	

试验条件 (TEST CONDITION)

- 1、盐水溶解 (SALT SOLUTION: 浓度 $50 \pm 10\text{g/L}$, PH值6.5-7.2).
- 2、试验室温度 (TEMP. IT THE SPRAY DHAMBR): $35 \pm 1^\circ\text{C}$.
- 3、盐水桶温度 (TEMP. OF SALE SOL' N TANK): $35 \pm 1^\circ\text{C}$.
- 4、压力桶温度 (TEMP. OF SAR SUPPLIERY): $47 \pm 1^\circ\text{C}$.
- 5、试验室相对湿度 (R. H IN THE CHAMBER) 85%.
- 6、压缩空气压力 (COMPRESSED AIR PRESSURE): $1.00 \pm 0.01\text{Kg/cm}^2$.
- 7、样品放置位置 (SPECIMEN SUPPORTED ANGLE): 尼龙绳吊挂 $70^\circ - 90^\circ$.
- 8、喷雾收集量 (COLLECT RATE OF SALT SOL' N) $1-2\text{mL}/(8 \text{ cm}^2\text{hr})$.
- 9、盐雾测试时间: 12小时 (H)

判定方法 (ADFUSGD METHOD)

试验后以20倍放大镜观察、无蓝、绿色腐蚀物之现象 (不包含折弯处), 即判定合格. (Inspext the ecimen at 20 xmagnification no blue or green corrosion products are acceptable)

样品序号	试验后现象	判定
	PHENOMENON AFTER TEST	COMMENT
1	无蓝、绿色腐蚀物之现象	OK
2	无蓝、绿色腐蚀物之现象	OK
3	无蓝、绿色腐蚀物之现象	OK
4	无蓝、绿色腐蚀物之现象	OK
5	无蓝、绿色腐蚀物之现象	OK

核准: 欠必锋

审核: 李娟

试验员: 但芬

鉅鼎銅材廠檢驗報告單

公司名稱 Customer	鉅鼎銅材廠檢驗報告單				重量 Weight(kg)	1078	出貨日期 Date	2021/11/23		
品名 Article	標準 Standard No				尺寸 Dimension		狀態 Tenper	銅卷編號 Coil No		
C2680	JISH3100:2017				0.18*400		EH	1021-C-08		
化學成分Chemical Compositions(%)										
元素 Element	Cu %	Zn%	Pb%	Fe%	\	\	\	\	化學成分	雜質
規範 Spec	64.0-68.0	餘量	<0.05	<0.05	\	\	\	\	合格	合格
實測 Actual	64.32	餘量	0.0036	0.0136	\	\	\	\	合格	合格
機械性質Mechanical Properties										
項目 Item	結晶粒度 Grain Size Mm	硬度 Hardness Hv	抗拉強度 TensionStrength Mpa	伸長度 Elongation %	導電率 Electrical Conduc %IACS	彎曲試驗 Bending Test 180	表面粗度 Surface Roughness Ra(u m)	彎曲度 Camber mm/n		
規範MAX Spec	\	170-190	490-610	\	\	\	\	\		
實測 Actual	\	178	574	5	\	\	\	\		

品質部



Materials Information

PRODUCT NAME: LCP M-401 BK

COMPOSITION/INFORMATION OF LCP M-401 BK

SUBSTANCE/MIXTURE: Mixture

SYNONYM(S): Aromatic Liquid Crystal Polymer(LCP)

品名	比例	用途
德众泰 LCP 树脂	0.565	构成材料主要成分
抗氧化剂	0.002	抗氧化
科莱恩热稳定剂	0.003	增加高温稳定性
黑色母	0.01	着色
滑石粉	0.2	增强剂, 增加流动性
玻纤	0.22	增强

NAME OF COMPANY: DZT Engineering Plastics Tech. Co.,Ltd

ADDRESS: Building 2 Zhichong Industrial Park, Hi-Tech Zone, Jiangmen City,
Guangdong Province, China

SECTION IN CHARGE: Quality Assurance Department

TEL/FAX: +86-750-3689920/+86-750-3689921

EMERGENCY TEL: +86-750-3689708



Test Report

No. CANEC2222380701

Date: 26 Oct 2022

Page 1 of 4

Client Name : SHENZHEN HUALIANWEI ELECTRONICS TECHNOLOGY CO.,LTD

Client Address : 101, 201, PLANT 1, NO.307, GUANLAN GUIHUA ROAD, GUIXIANG COMMUNITY, GUANLAN SUB-DISTRICT, LONGHUA DISTRICT, SHENZHEN CITY, GUANGDONG PROVINCE, CHINA

Sample Name : C2680 Terminal

Model No. : C2680 terminal after plating

Client Ref. Info. : Used for USB series, HDMI series, RJ series, 1394 series, MICRO series, MINI series, DISPLAYPORT series, VGA series, DVI series, TYPE-C series, JACK series

The above sample(s) and information were provided by the client.

SGS Job No. : CP22-057100 - GZ

Date of Sample Received : 20 Oct 2022

Testing Period : 20 Oct 2022 - 26 Oct 2022

Test Requested : Selected test(s) as requested by the client.

Test Method(s) : Please refer to next page(s).

Test Result(s) : Please refer to next page(s).

Result Summary :

Test Requested	Conclusion
EU RoHS Directive (EU) 2015/863 amending Annex II to Directive 2011/65/EU- Lead, Mercury, Cadmium and Hexavalent chromium	PASS

Signed for and on behalf of
SGS-CSTC Standards Technical Services Co., Ltd. Guangzhou Branch

Dongyu Xie

Dongyu Xie
Approved Signatory

scan to see the report



A17521CE



SGS-CSTC Standards Technical Services Co., Ltd.
Guangzhou Branch Testing Center Chemical Laboratory

Unless otherwise agreed in writing, this document is issued by the Company subject to its General Conditions of Service printed overleaf, available on request or accessible at <http://www.sgs.com/en/Terms-and-Conditions.aspx> and, for electronic format documents, subject to Terms and Conditions for Electronic Documents at <http://www.sgs.com/en/Terms-and-Conditions/Terms-e-Document.aspx>. Attention is drawn to the limitation of liability, indemnification and jurisdiction issues defined therein. Any holder of this document is advised that information contained hereon reflects the Company's findings at the time of its intervention only and within the limits of Client's instructions, if any. The Company's sole responsibility is to its Client and this document does not exonerate parties to a transaction from exercising all their rights and obligations under the transaction documents. This document cannot be reproduced except in full, without prior written approval of the Company. Any unauthorized alteration, forgery or falsification of the content or appearance of this document is unlawful and offenders may be prosecuted to the fullest extent of the law. Unless otherwise stated the results shown in this test report refer only to the sample(s) tested.

Attention: To check the authenticity of testing /inspection report & certificate, please contact us at telephone: (86-755) 8307 1443, or email: CN.Doccheck@sgs.com

198 Kezhu Road, Sciencetech Park Guangzhou Economic & Technology Development District, Guangzhou, China 510663

中国·广州·经济技术开发区科学城科珠路198号

邮编: 510663

t (86-20) 82155555

www.sgs.com

t (86-20) 82155555

sgs.china@sgs.com

Test Report

No. CANEC2222380701

Date: 26 Oct 2022

Page 2 of 4

Test Result(s) :

Test Part Description :

Specimen No.	SGS Sample ID	Description
SN1	CAN22-223807.001	Silver-grey/brassy metal

Remarks :

- (1) 1 mg/kg = 0.0001%
- (2) MDL = Method Detection Limit
- (3) ND = Not Detected (< MDL)
- (4) "-" = Not Regulated

EU RoHS Directive (EU) 2015/863 amending Annex II to Directive 2011/65/EU- Lead, Mercury, Cadmium and Hexavalent chromium

Test Method : With reference to IEC 62321-4:2013+A1:2017, IEC 62321-5:2013, IEC 62321-7-1:2015, analyzed by ICP-OES and UV-Vis .

<u>Test Item(s)</u>	<u>Limit</u>	<u>Unit</u>	<u>MDL</u>	<u>001</u>
Cadmium (Cd)	100	mg/kg	2	ND
Lead (Pb)	1000	mg/kg	2	3
Mercury (Hg)	1000	mg/kg	2	ND
Hexavalent Chromium (Cr(VI))▼	-	µg/cm ²	0.10	ND

Notes :

- (1) The maximum permissible limit is quoted from RoHS Directive (EU) 2015/863.
 - (2) IEC 62321 series is equivalent to EN 62321 series
 - (3) ▼= a. The sample is positive for CrVI if the CrVI concentration is greater than 0.13 µg/cm². The sample coating is considered to contain CrVI
 b. The sample is negative for CrVI if CrVI is ND (concentration less than 0.10 µg/cm²). The coating is considered a non-CrVI based coating
 c. The result between 0.10 µg/cm² and 0.13 µg/cm² is considered to be inconclusive - unavoidable coating variations may influence the determination
- Information on storage conditions and production date of the tested sample is unavailable and thus Cr(VI) results represent status of the sample at the time of testing.

Unless otherwise stated, the decision rule for conformity reporting is based on Binary Statement for Simple Acceptance Rule (w=0) stated in ILAC-G8:09/2019.



Unless otherwise agreed in writing, this document is issued by the Company subject to its General Conditions of Service printed overleaf, available on request or accessible at <http://www.sgs.com/en/Terms-and-Conditions.aspx> and, for electronic format documents, subject to Terms and Conditions for Electronic Documents at <http://www.sgs.com/en/Terms-and-Conditions/Terms-e-Documents.aspx>. Attention is drawn to the limitation of liability, indemnification and jurisdiction issues defined therein. Any holder of this document is advised that information contained hereon reflects the Company's findings at the time of its intervention only and within the limits of Client's instructions, if any. The Company's sole responsibility is to its Client and this document does not exonerate parties to a transaction from exercising all their rights and obligations under the transaction documents. This document cannot be reproduced except in full, without prior written approval of the Company. Any unauthorized alteration, forgery or falsification of the content or appearance of this document is unlawful and offenders may be prosecuted to the fullest extent of the law. Unless otherwise stated the results shown in this test report refer only to the sample(s) tested.

Attention: To check the authenticity of testing /inspection report & certificate, please contact us at telephone: (86-755) 8307 1443, or email: CN.Doccheck@sgs.com

ATTACHMENTS

Pb/Cd/Hg/Cr⁶⁺ Testing Flow Chart

1) These samples were dissolved totally by pre-conditioning method according to below flow chart. (Cr⁶⁺ test method excluded).

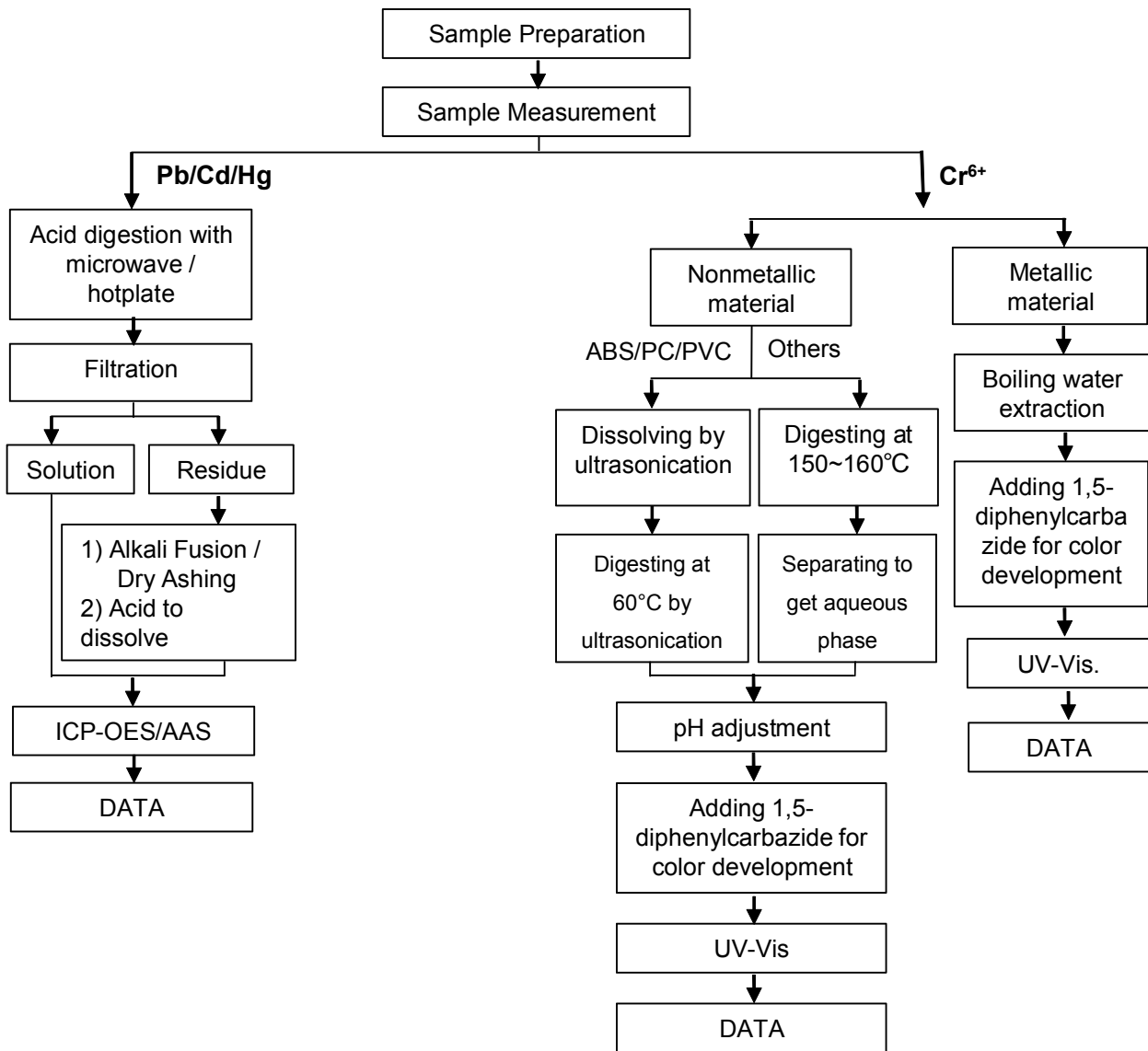

Unless otherwise agreed in writing, this document is issued by the Company subject to its General Conditions of Service printed overleaf, available on request or accessible at <http://www.sgs.com/en/Terms-and-Conditions.aspx> and, for electronic format documents, subject to Terms and Conditions for Electronic Documents at <http://www.sgs.com/en/Terms-and-Conditions/Terms-e-Documents.aspx>. Attention is drawn to the limitation of liability, indemnification and jurisdiction issues defined therein. Any holder of this document is advised that information contained hereon reflects the Company's findings at the time of its intervention only and within the limits of Client's instructions, if any. The Company's sole responsibility is to its Client and this document does not exonerate parties to a transaction from exercising all their rights and obligations under the transaction documents. This document cannot be reproduced except in full, without prior written approval of the Company. Any unauthorized alteration, forgery or falsification of the content or appearance of this document is unlawful and offenders may be prosecuted to the fullest extent of the law. Unless otherwise stated the results shown in this test report refer only to the sample(s) tested.

Attention: To check the authenticity of testing / inspection report & certificate, please contact us at telephone: (86-755) 8307 1443, or email: CN.Doccheck@sgs.com

Sample photo:



SGS authenticate the photo on original report only

*** End of Report ***



Test Report

No. CANEC2222380708

Date: 26 Oct 2022

Page 1 of 6

Client Name : SHENZHEN HUALIANWEI ELECTRONICS TECHNOLOGY CO.,LTD

Client Address : 101, 201, PLANT 1, NO.307, GUANLAN GUIHUA ROAD, GUIXIANG COMMUNITY, GUANLAN SUB-DISTRICT, LONGHUA DISTRICT, SHENZHEN CITY, GUANGDONG PROVINCE, CHINA

Sample Name : LCP plastic black color

Model No. : LCP Plastic

Client Ref. Info. : Used for USB series, HDMI series, RJ series, 1394 series, MICRO series, MINI series, DISPLAYPORT series, VGA series, DVI series, TYPE-C series, JACK series

The above sample(s) and information were provided by the client.

SGS Job No. : CP22-057100 - GZ

Date of Sample Received : 20 Oct 2022

Testing Period : 20 Oct 2022 - 26 Oct 2022

Test Requested : Selected test(s) as requested by the client.

Test Method(s) : Please refer to next page(s).

Test Result(s) : Please refer to next page(s).

Result Summary :

Test Requested	Conclusion
EU RoHS Directive (EU) 2015/863 amending Annex II to Directive 2011/65/EU- Lead, Mercury, Cadmium, Hexavalent chromium, Polybrominated biphenyls (PBBs), Polybrominated diphenyl ethers (PBDEs), Bis(2-ethylhexyl) phthalate (DEHP), Butyl benzyl phthalate (BBP), Dibutyl phthalate (DBP) and Diisobutyl phthalate (DIBP)	PASS

Signed for and on behalf of
SGS-CSTC Standards Technical Services Co., Ltd. Guangzhou Branch

Dongyu Xie

Dongyu Xie
Approved Signatory

scan to see the report



689ECF7B



Test Report

No. CANEC2222380708

Date: 26 Oct 2022

Page 2 of 6

Test Result(s) :

Test Part Description :

Specimen No.	SGS Sample ID	Description
SN1	CAN22-223807.008	Black plastic

Remarks :

- (1) 1 mg/kg = 0.0001%
- (2) MDL = Method Detection Limit
- (3) ND = Not Detected (< MDL)
- (4) "-" = Not Regulated

EU RoHS Directive (EU) 2015/863 amending Annex II to Directive 2011/65/EU- Lead, Mercury, Cadmium, Hexavalent chromium, Polybrominated biphenyls (PBBs), Polybrominated diphenyl ethers (PBDEs), Bis(2-ethylhexyl) phthalate (DEHP), Butyl benzyl phthalate (BBP), Dibutyl phthalate (DBP) and Diisobutyl phthalate (DIBP)

Test Method : With reference to IEC 62321-4:2013+A1:2017, IEC 62321-5:2013, IEC 62321-7-2:2017 , IEC 62321-6:2015 and IEC 62321-8:2017, analyzed by ICP-OES , UV-Vis and GC-MS .

<u>Test Item(s)</u>	<u>Limit</u>	<u>Unit</u>	<u>MDL</u>	<u>008</u>
Cadmium (Cd)	100	mg/kg	2	ND
Lead (Pb)	1000	mg/kg	2	6
Mercury (Hg)	1000	mg/kg	2	ND
Hexavalent Chromium (CrVI)	1000	mg/kg	8	ND
Sum of PBBs	1000	mg/kg	-	ND
Monobromobiphenyl	-	mg/kg	5	ND
Dibromobiphenyl	-	mg/kg	5	ND
Tribromobiphenyl	-	mg/kg	5	ND
Tetrabromobiphenyl	-	mg/kg	5	ND
Pentabromobiphenyl	-	mg/kg	5	ND
Hexabromobiphenyl	-	mg/kg	5	ND
Heptabromobiphenyl	-	mg/kg	5	ND
Octabromobiphenyl	-	mg/kg	5	ND
Nonabromobiphenyl	-	mg/kg	5	ND
Decabromobiphenyl	-	mg/kg	5	ND
Sum of PBDEs	1000	mg/kg	-	ND
Monobromodiphenyl ether	-	mg/kg	5	ND
Dibromodiphenyl ether	-	mg/kg	5	ND
Tribromodiphenyl ether	-	mg/kg	5	ND
Tetrabromodiphenyl ether	-	mg/kg	5	ND



Unless otherwise agreed in writing, this document is issued by the Company subject to its General Conditions of Service printed overleaf, available on request or accessible at <http://www.sgs.com/en/Terms-and-Conditions.aspx> and, for electronic format documents, subject to Terms and Conditions for Electronic Documents at <http://www.sgs.com/en/Terms-and-Conditions/Terms-e-Documents.aspx>. Attention is drawn to the limitation of liability, indemnification and jurisdiction issues defined therein. Any holder of this document is advised that information contained hereon reflects the Company's findings at the time of its intervention only and within the limits of Client's instructions, if any. The Company's sole responsibility is to its Client and this document does not exonerate parties to a transaction from exercising all their rights and obligations under the transaction documents. This document cannot be reproduced except in full, without prior written approval of the Company. Any unauthorized alteration, forgery or falsification of the content or appearance of this document is unlawful and offenders may be prosecuted to the fullest extent of the law. Unless otherwise stated the results shown in this test report refer only to the sample(s) tested.

Attention: To check the authenticity of testing /inspection report & certificate, please contact us at telephone: (86-755) 8307 1443, or email: CN.Doccheck@sgs.com

Test Report

No. CANEC2222380708

Date: 26 Oct 2022

Page 3 of 6

<u>Test Item(s)</u>	<u>Limit</u>	<u>Unit</u>	<u>MDL</u>	<u>008</u>
Pentabromodiphenyl ether	-	mg/kg	5	ND
Hexabromodiphenyl ether	-	mg/kg	5	ND
Heptabromodiphenyl ether	-	mg/kg	5	ND
Octabromodiphenyl ether	-	mg/kg	5	ND
Nonabromodiphenyl ether	-	mg/kg	5	ND
Decabromodiphenyl ether	-	mg/kg	5	ND
Dibutyl phthalate (DBP)	1000	mg/kg	50	ND
Butyl benzyl phthalate (BBP)	1000	mg/kg	50	ND
Bis (2-ethylhexyl) phthalate (DEHP)	1000	mg/kg	50	ND
Diisobutyl Phthalates (DIBP)	1000	mg/kg	50	ND

Notes :

- (1) The maximum permissible limit is quoted from RoHS Directive (EU) 2015/863.
- (2) IEC 62321 series is equivalent to EN 62321 series
- (3) The restriction of DEHP, BBP, DBP and DIBP shall apply to medical devices, including in vitro medical devices, and monitoring and control instruments, including industrial monitoring and control instruments, from 22 July 2021.

Unless otherwise stated, the decision rule for conformity reporting is based on Binary Statement for Simple Acceptance Rule ($w=0$) stated in ILAC-G8:09/2019.



Unless otherwise agreed in writing, this document is issued by the Company subject to its General Conditions of Service printed overleaf, available on request or accessible at <http://www.sgs.com/en/Terms-and-Conditions.aspx> and, for electronic format documents, subject to Terms and Conditions for Electronic Documents at <http://www.sgs.com/en/Terms-and-Conditions/Terms-e-Documents.aspx>. Attention is drawn to the limitation of liability, indemnification and jurisdiction issues defined therein. Any holder of this document is advised that information contained hereon reflects the Company's findings at the time of its intervention only and within the limits of Client's instructions, if any. The Company's sole responsibility is to its Client and this document does not exonerate parties to a transaction from exercising all their rights and obligations under the transaction documents. This document cannot be reproduced except in full, without prior written approval of the Company. Any unauthorized alteration, forgery or falsification of the content or appearance of this document is unlawful and offenders may be prosecuted to the fullest extent of the law. Unless otherwise stated the results shown in this test report refer only to the sample(s) tested.

Attention: To check the authenticity of testing /inspection report & certificate, please contact us at telephone: (86-755) 8307 1443, or email: CN.Doccheck@sgs.com

ATTACHMENTS

Pb/Cd/Hg/Cr⁶⁺/PBBs/PBDEs Testing Flow Chart

1) These samples were dissolved totally by pre-conditioning method according to below flow chart. (Cr⁶⁺ and PBBs/PBDEs test method excluded).

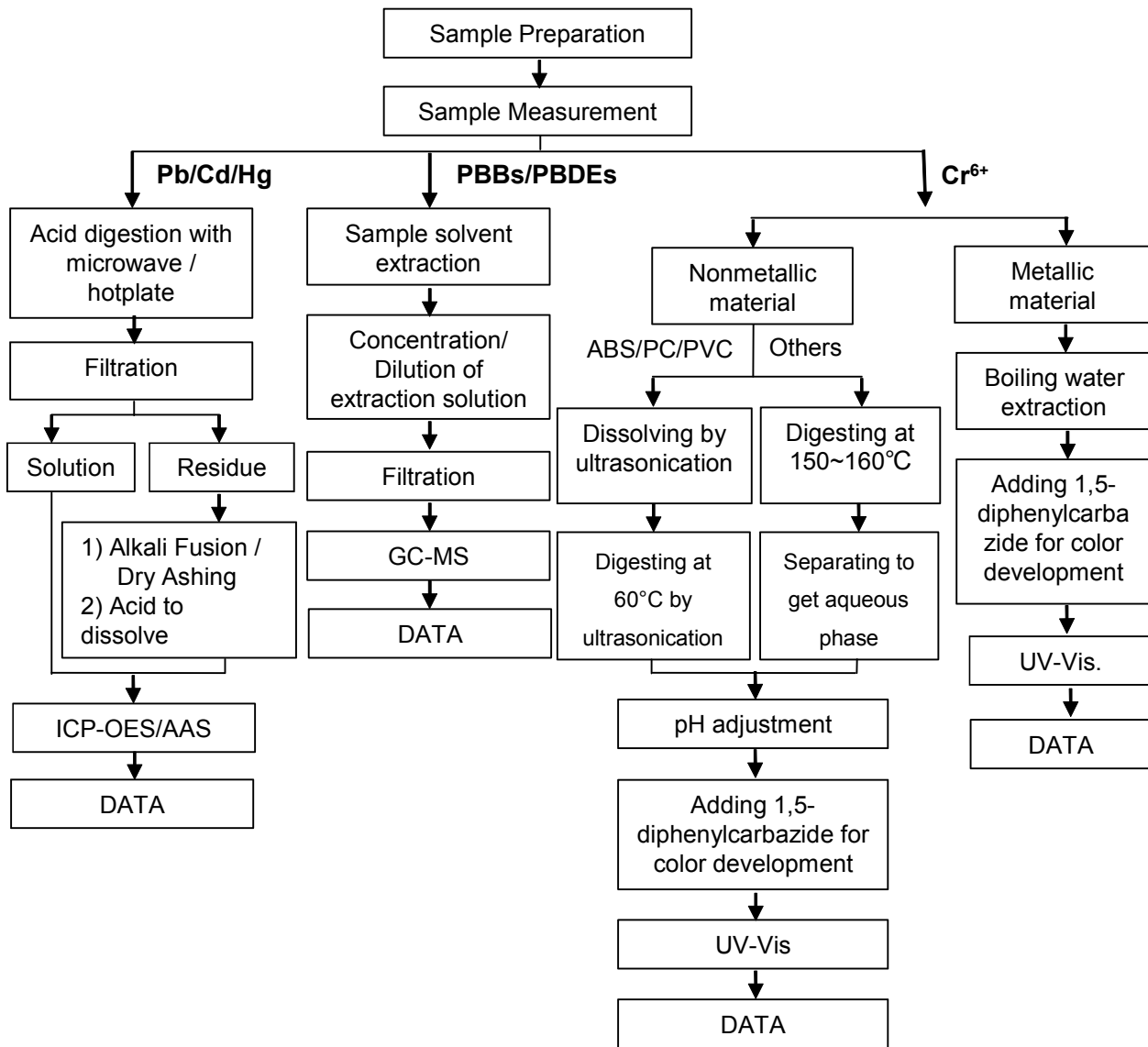

ATTACHMENTS

Phthalates Testing Flow Chart

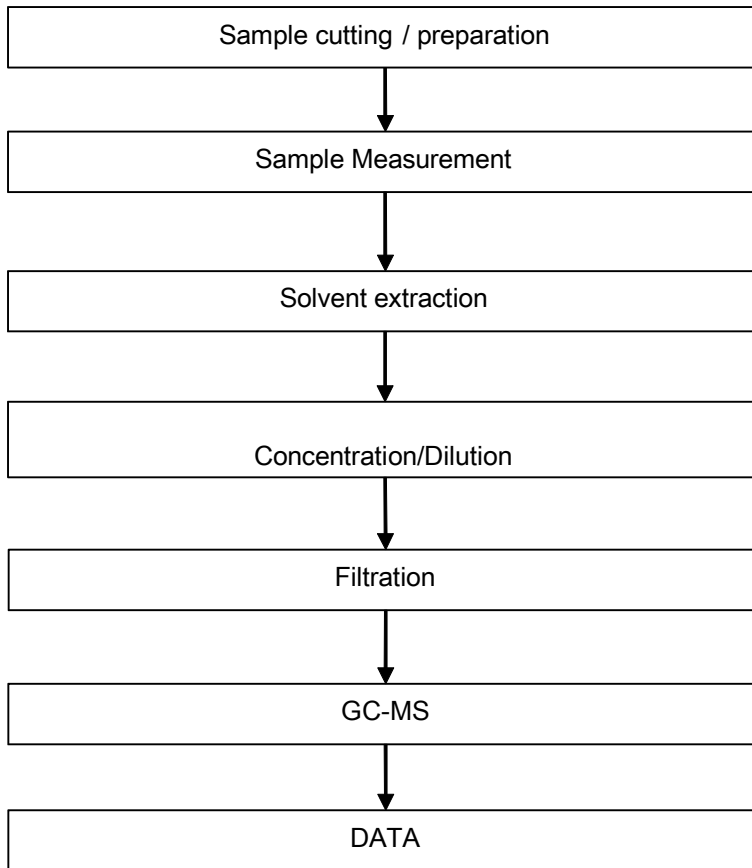

Unless otherwise agreed in writing, this document is issued by the Company subject to its General Conditions of Service printed overleaf, available on request or accessible at <http://www.sgs.com/en/Terms-and-Conditions.aspx> and, for electronic format documents, subject to Terms and Conditions for Electronic Documents at <http://www.sgs.com/en/Terms-and-Conditions/Terms-e-Document.aspx>. Attention is drawn to the limitation of liability, indemnification and jurisdiction issues defined therein. Any holder of this document is advised that information contained hereon reflects the Company's findings at the time of its intervention only and within the limits of Client's instructions, if any. The Company's sole responsibility is to its Client and this document does not exonerate parties to a transaction from exercising all their rights and obligations under the transaction documents. This document cannot be reproduced except in full, without prior written approval of the Company. Any unauthorized alteration, forgery or falsification of the content or appearance of this document is unlawful and offenders may be prosecuted to the fullest extent of the law. Unless otherwise stated the results shown in this test report refer only to the sample(s) tested.

Attention: To check the authenticity of testing / inspection report & certificate, please contact us at telephone: (86-755) 8307 1443, or email: CN_Doccheck@sgs.com

Sample photo:



SGS authenticate the photo on original report only

*** End of Report ***



Test Report

No. CANEC2218227001

Date: 30 Aug 2022

Page 1 of 8

Client Name : SHENZHEN CITY TONGHUA INDUSTRY CO.,LTD

Client Address : TONGHUA MANSIN TONGLE XINBU VILLANG TOWN SHENZHEN CITY CHINA

Sample Name : Nickel(Ni)

The above sample(s) and information were provided by the client.

SGS Job No. : CP22-047169 - SZ
 Date of Sample Received : 25 Aug 2022
 Testing Period : 25 Aug 2022 - 30 Aug 2022
 Test Requested : Selected test(s) as requested by the client.
 Test Method(s) : Please refer to next page(s).
 Test Result(s) : Please refer to next page(s).

Result Summary :

Test Requested	Conclusion
EU RoHS Directive (EU) 2015/863 amending Annex II to Directive 2011/65/EU- Lead, Mercury, Cadmium, Hexavalent chromium, Polybrominated biphenyls (PBBs), Polybrominated diphenyl ethers (PBDEs), Bis(2-ethylhexyl) phthalate (DEHP), Butyl benzyl phthalate (BBP), Dibutyl phthalate (DBP) and Diisobutyl phthalate (DIBP)	PASS
Perfluorooctanoic acid (PFOA) and its salts & Perfluorooctane sulfonates (PFOS) and its derivatives	See Results

Signed for and on behalf of
 SGS-CSTC Standards Technical Services Co., Ltd. Guangzhou Branch

Dongyu Xie

Dongyu Xie
 Approved Signatory

scan to see the report



5753937E



Test Report

No. CANEC2218227001

Date: 30 Aug 2022

Page 2 of 8

Test Result(s) :

Test Part Description :

Specimen No.	SGS Sample ID	Description
SN1	CAN22-182270.001	Silver-gray plated metal

Remarks :

- (1) 1 mg/kg = 0.0001%
- (2) MDL = Method Detection Limit
- (3) ND = Not Detected (< MDL)
- (4) "-" = Not Regulated

EU RoHS Directive (EU) 2015/863 amending Annex II to Directive 2011/65/EU- Lead, Mercury, Cadmium, Hexavalent chromium, Polybrominated biphenyls (PBBs), Polybrominated diphenyl ethers (PBDEs), Bis(2-ethylhexyl) phthalate (DEHP), Butyl benzyl phthalate (BBP), Dibutyl phthalate (DBP) and Diisobutyl phthalate (DIBP)

Test Method : With reference to IEC 62321-4:2013+A1:2017, IEC 62321-5:2013, IEC 62321-7-1:2015 , IEC 62321-6:2015 and IEC 62321-8:2017, analyzed by ICP-OES , UV-Vis and GC-MS .

Test Item(s)	Limit	Unit	MDL	001
Cadmium (Cd)	100	mg/kg	2	ND
Lead (Pb)	1000	mg/kg	2	49
Mercury (Hg)	1000	mg/kg	2	ND
Hexavalent Chromium (Cr(VI))▼	-	µg/cm ²	0.10	ND
Sum of PBBs	1000	mg/kg	-	ND
Monobromobiphenyl	-	mg/kg	5	ND
Dibromobiphenyl	-	mg/kg	5	ND
Tribromobiphenyl	-	mg/kg	5	ND
Tetrabromobiphenyl	-	mg/kg	5	ND
Pentabromobiphenyl	-	mg/kg	5	ND
Hexabromobiphenyl	-	mg/kg	5	ND
Heptabromobiphenyl	-	mg/kg	5	ND
Octabromobiphenyl	-	mg/kg	5	ND
Nonabromobiphenyl	-	mg/kg	5	ND
Decabromobiphenyl	-	mg/kg	5	ND
Sum of PBDEs	1000	mg/kg	-	ND
Monobromodiphenyl ether	-	mg/kg	5	ND
Dibromodiphenyl ether	-	mg/kg	5	ND
Tribromodiphenyl ether	-	mg/kg	5	ND
Tetrabromodiphenyl ether	-	mg/kg	5	ND



Unless otherwise agreed in writing, this document is issued by the Company subject to its General Conditions of Service printed overleaf, available on request or accessible at <http://www.sgs.com/en/Terms-and-Conditions.aspx> and, for electronic format documents, subject to Terms and Conditions for Electronic Documents at <http://www.sgs.com/en/Terms-and-Conditions/Terms-e-Document.aspx>. Attention is drawn to the limitation of liability, indemnification and jurisdiction issues defined therein. Any holder of this document is advised that information contained hereon reflects the Company's findings at the time of its intervention only and within the limits of Client's instructions, if any. The Company's sole responsibility is to its Client and this document does not exonerate parties to a transaction from exercising all their rights and obligations under the transaction documents. This document cannot be reproduced except in full, without prior written approval of the Company. Any unauthorized alteration, forgery or falsification of the content or appearance of this document is unlawful and offenders may be prosecuted to the fullest extent of the law. Unless otherwise stated the results shown in this test report refer only to the sample(s) tested.

Attention: To check the authenticity of testing /inspection report & certificate, please contact us at telephone: (86-755) 8307 1443, or email: CN.Doccheck@sgs.com

Test Report

No. CANEC2218227001

Date: 30 Aug 2022

Page 3 of 8

<u>Test Item(s)</u>	<u>Limit</u>	<u>Unit</u>	<u>MDL</u>	<u>001</u>
Pentabromodiphenyl ether	-	mg/kg	5	ND
Hexabromodiphenyl ether	-	mg/kg	5	ND
Heptabromodiphenyl ether	-	mg/kg	5	ND
Octabromodiphenyl ether	-	mg/kg	5	ND
Nonabromodiphenyl ether	-	mg/kg	5	ND
Decabromodiphenyl ether	-	mg/kg	5	ND
Dibutyl phthalate (DBP)	1000	mg/kg	50	ND
Butyl benzyl phthalate (BBP)	1000	mg/kg	50	ND
Bis (2-ethylhexyl) phthalate (DEHP)	1000	mg/kg	50	ND
Diisobutyl Phthalates (DIBP)	1000	mg/kg	50	ND

Notes :

- (1) The maximum permissible limit is quoted from RoHS Directive (EU) 2015/863.
- (2) IEC 62321 series is equivalent to EN 62321 series
- (3) ▼= a. The sample is positive for CrVI if the CrVI concentration is greater than 0.13 $\mu\text{g}/\text{cm}^2$. The sample coating is considered to contain CrVI
 b. The sample is negative for CrVI if CrVI is ND (concentration less than 0.10 $\mu\text{g}/\text{cm}^2$). The coating is considered a non-CrVI based coating
 c. The result between 0.10 $\mu\text{g}/\text{cm}^2$ and 0.13 $\mu\text{g}/\text{cm}^2$ is considered to be inconclusive - unavoidable coating variations may influence the determination
 Information on storage conditions and production date of the tested sample is unavailable and thus Cr(VI) results represent status of the sample at the time of testing.

Perfluorooctanoic acid (PFOA) and its salts & Perfluorooctane sulfonates (PFOS) and its derivatives

Test Method : With reference to CEN/TS15968:2010, analysis was performed by LC-MS or LC-MS/MS.

<u>Test Item(s)</u>	<u>CAS NO.</u>	<u>Unit</u>	<u>MDL</u>	<u>001</u>
Perfluorooctanoic acid (PFOA) and its salts+	335-67-1	mg/kg	0.010	ND
Perfluorooctane sulfonates (PFOS) ^	1763-23-1	mg/kg	0.010	ND
Perfluorooctane Sulfonamide (PFOSA)	754-91-6	mg/kg	0.010	ND
N-methylperfluoro-1-octanesulfonamide(MeFOSA)	31506-32-8	mg/kg	0.010	ND
N-ethylperfluoro-1-octanesulfonamide (EtFOSA)	4151-50-2	mg/kg	0.010	ND
2-(N-methylperfluoro-1-octanesulfonamido)-ethanol(MeFOSE)	24448-09-7	mg/kg	0.010	ND
2-(N-ethylperfluoro-1-octanesulfonamido)-ethanol(EtFOSE)	1691-99-2	mg/kg	0.010	ND
Perfluorooctane sulfonates (PFOS) and its derivatives	-	mg/kg	-	ND

Notes :



Unless otherwise agreed in writing, this document is issued by the Company subject to its General Conditions of Service printed overleaf, available on request or accessible at <http://www.sgs.com/en/Terms-and-Conditions.aspx> and, for electronic format documents, subject to Terms and Conditions for Electronic Documents at <http://www.sgs.com/en/Terms-and-Conditions/Terms-e-Documents.aspx>. Attention is drawn to the limitation of liability, indemnification and jurisdiction issues defined therein. Any holder of this document is advised that information contained hereon reflects the Company's findings at the time of its intervention only and within the limits of Client's instructions, if any. The Company's sole responsibility is to its Client and this document does not exonerate parties to a transaction from exercising all their rights and obligations under the transaction documents. This document cannot be reproduced except in full, without prior written approval of the Company. Any unauthorized alteration, forgery or falsification of the content or appearance of this document is unlawful and offenders may be prosecuted to the fullest extent of the law. Unless otherwise stated the results shown in this test report refer only to the sample(s) tested.

Attention: To check the authenticity of testing /inspection report & certificate, please contact us at telephone: (86-755) 8307 1443, or email: CN.Doccheck@sgs.com

- (1) + PFOA and its salts including PFOA-Na (CAS No.: 335-95-5), PFOA-K (CAS No.: 2395-00-8), PFOA-Ag (CAS No.: 335-93-3), PFOA-F (CAS No.: 335-66-0) and APFO (CAS No.: 3825-26-1);
- (2) ^ PFOS including PFOS-K (CAS No.: 2795-39-3), PFOS-Li (CAS No.: 29457-72-5), PFOS-NH₄ (CAS No.: 29081-56-9), PFOS-NH(OH)₂ (CAS No.: 70225-14-8), PFOS-N(C₂H₅)₄ (CAS No.: 56773-42-3), PFOS-DDA(CAS No.:251099-16-8) and POSF (CAS No.: 307-35-7)

Unless otherwise stated, the decision rule for conformity reporting is based on Binary Statement for Simple Acceptance Rule ($w=0$) stated in ILAC-G8:09/2019.



Unless otherwise agreed in writing, this document is issued by the Company subject to its General Conditions of Service printed overleaf, available on request or accessible at <http://www.sgs.com/en/Terms-and-Conditions.aspx> and, for electronic format documents, subject to Terms and Conditions for Electronic Documents at <http://www.sgs.com/en/Terms-and-Conditions/Terms-e-Documents.aspx>. Attention is drawn to the limitation of liability, indemnification and jurisdiction issues defined therein. Any holder of this document is advised that information contained hereon reflects the Company's findings at the time of its intervention only and within the limits of Client's instructions, if any. The Company's sole responsibility is to its Client and this document does not exonerate parties to a transaction from exercising all their rights and obligations under the transaction documents. This document cannot be reproduced except in full, without prior written approval of the Company. Any unauthorized alteration, forgery or falsification of the content or appearance of this document is unlawful and offenders may be prosecuted to the fullest extent of the law. Unless otherwise stated the results shown in this test report refer only to the sample(s) tested.

Attention: To check the authenticity of testing /inspection report & certificate, please contact us at telephone: (86-755) 8307 1443, or email: CN.Doccheck@sgs.com

ATTACHMENTS

Pb/Cd/Hg/Cr⁶⁺/PBBs/PBDEs Testing Flow Chart

1) These samples were dissolved totally by pre-conditioning method according to below flow chart. (Cr⁶⁺ and PBBs/PBDEs test method excluded).

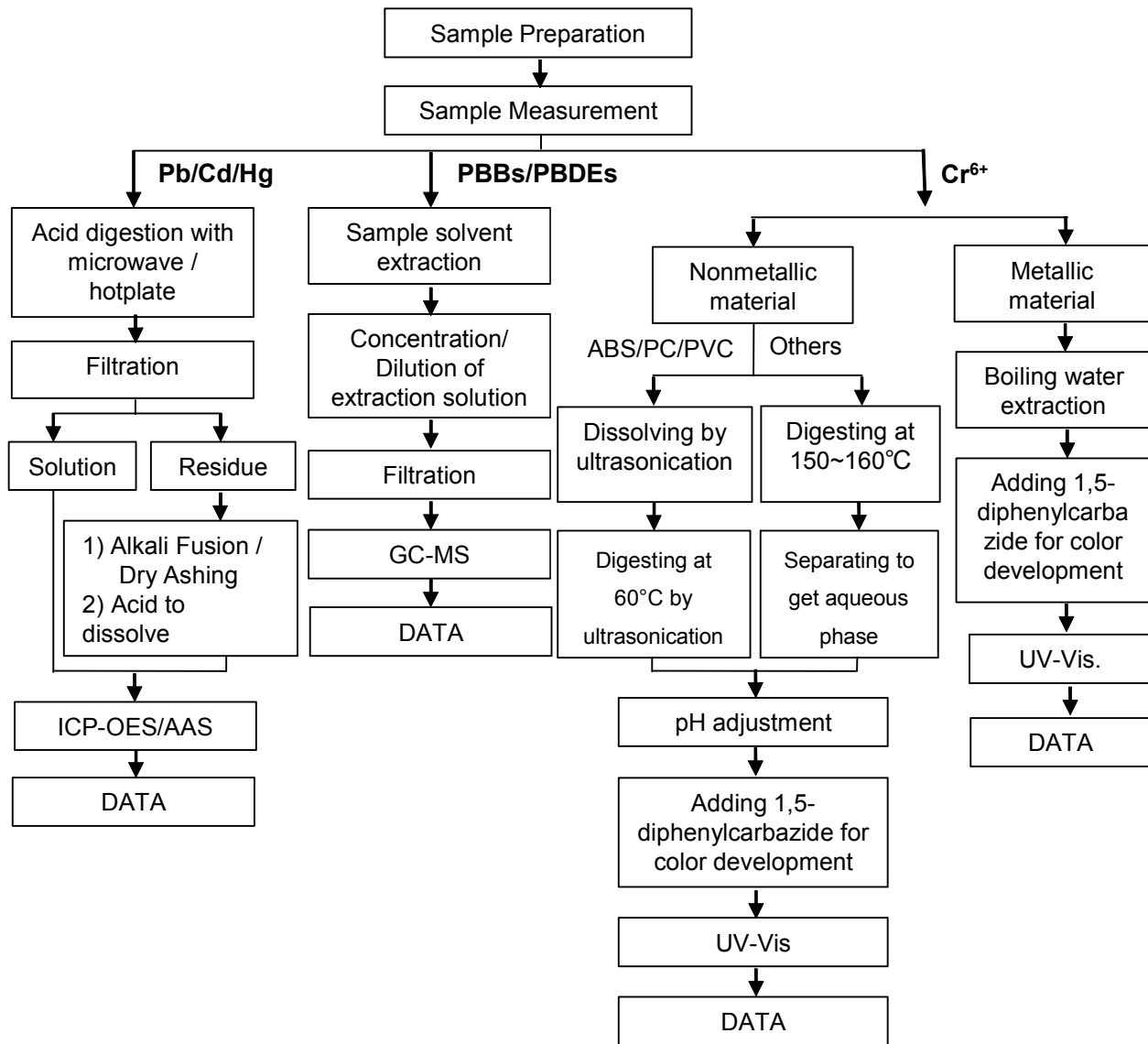

ATTACHMENTS

Phthalates Testing Flow Chart

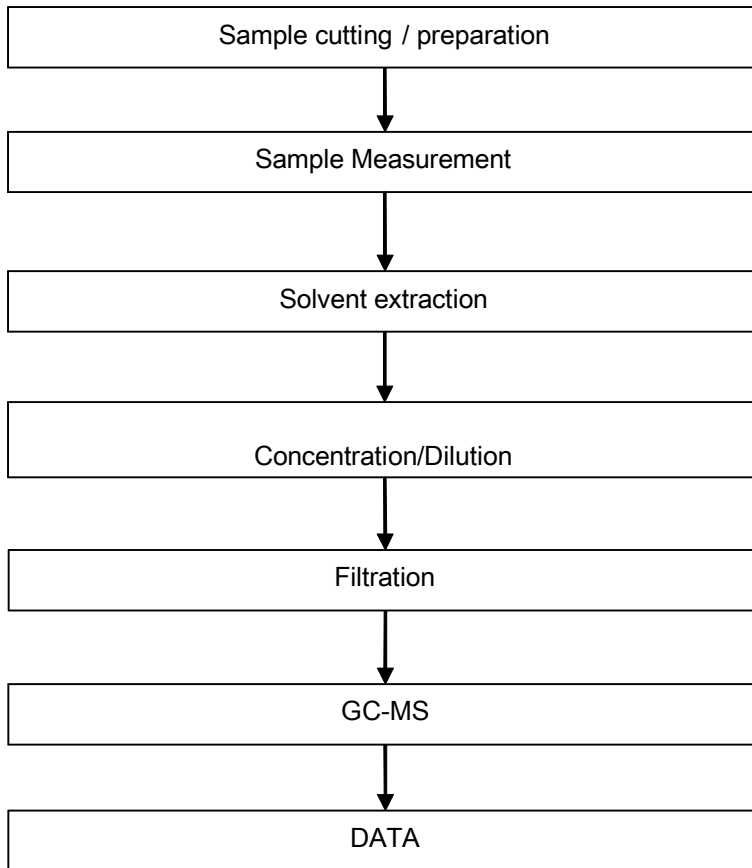

Unless otherwise agreed in writing, this document is issued by the Company subject to its General Conditions of Service printed overleaf, available on request or accessible at <http://www.sgs.com/en/Terms-and-Conditions.aspx> and, for electronic format documents, subject to Terms and Conditions for Electronic Documents at <http://www.sgs.com/en/Terms-and-Conditions/Terms-e-Document.aspx>. Attention is drawn to the limitation of liability, indemnification and jurisdiction issues defined therein. Any holder of this document is advised that information contained hereon reflects the Company's findings at the time of its intervention only and within the limits of Client's instructions, if any. The Company's sole responsibility is to its Client and this document does not exonerate parties to a transaction from exercising all their rights and obligations under the transaction documents. This document cannot be reproduced except in full, without prior written approval of the Company. Any unauthorized alteration, forgery or falsification of the content or appearance of this document is unlawful and offenders may be prosecuted to the fullest extent of the law. Unless otherwise stated the results shown in this test report refer only to the sample(s) tested.

Attention: To check the authenticity of testing / inspection report & certificate, please contact us at telephone: (86-755) 8307 1443, or email: CN.Doccheck@sgs.com

ATTACHMENTS

PFOA / PFOS Testing Flow Chart

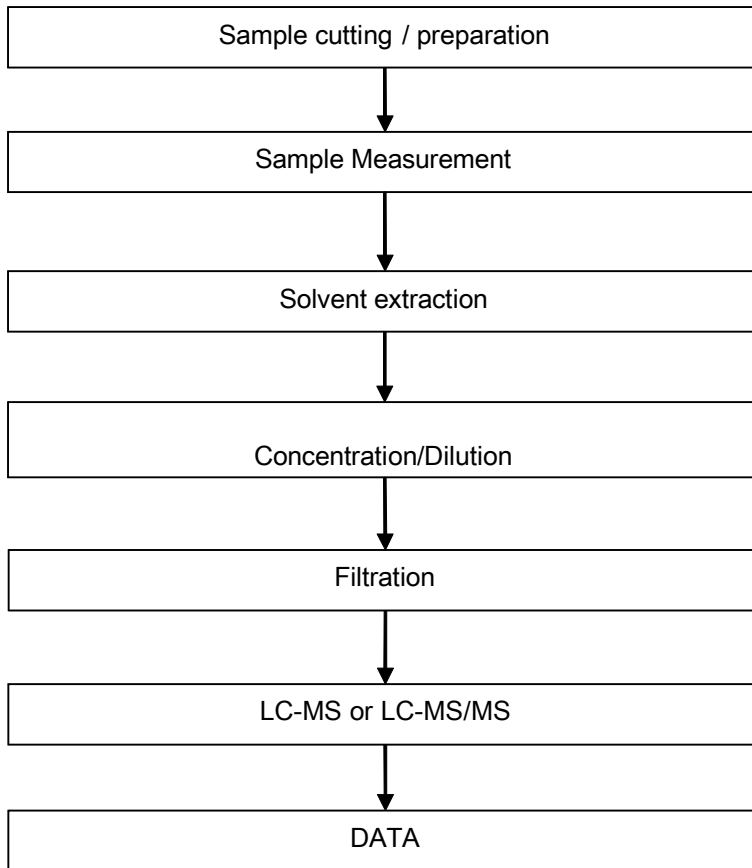

Unless otherwise agreed in writing, this document is issued by the Company subject to its General Conditions of Service printed overleaf, available on request or accessible at <http://www.sgs.com/en/Terms-and-Conditions.aspx> and, for electronic format documents, subject to Terms and Conditions for Electronic Documents at <http://www.sgs.com/en/Terms-and-Conditions/Terms-e-Document.aspx>. Attention is drawn to the limitation of liability, indemnification and jurisdiction issues defined therein. Any holder of this document is advised that information contained hereon reflects the Company's findings at the time of its intervention only and within the limits of Client's instructions, if any. The Company's sole responsibility is to its Client and this document does not exonerate parties to a transaction from exercising all their rights and obligations under the transaction documents. This document cannot be reproduced except in full, without prior written approval of the Company. Any unauthorized alteration, forgery or falsification of the content or appearance of this document is unlawful and offenders may be prosecuted to the fullest extent of the law. Unless otherwise stated the results shown in this test report refer only to the sample(s) tested.

Attention: To check the authenticity of testing / inspection report & certificate, please contact us at telephone: (86-755) 8307 1443, or email: CN.Doccheck@sgs.com

Sample photo:



SGS authenticate the photo on original report only

*** End of Report ***



Test Report

No. CANEC2218227003

Date: 30 Aug 2022

Page 1 of 8

Client Name : SHENZHEN CITY TONGHUA INDUSTRY CO.,LTD

Client Address : TONGHUA MANSIN TONGLE XINBU VILLANG TOWN SHENZHEN CITY CHINA

Sample Name : Bright Tin(SN)

The above sample(s) and information were provided by the client.

SGS Job No. : CP22-047169 - SZ
 Date of Sample Received : 25 Aug 2022
 Testing Period : 25 Aug 2022 - 30 Aug 2022
 Test Requested : Selected test(s) as requested by the client.
 Test Method(s) : Please refer to next page(s).
 Test Result(s) : Please refer to next page(s).

Result Summary :

Test Requested	Conclusion
EU RoHS Directive (EU) 2015/863 amending Annex II to Directive 2011/65/EU- Lead, Mercury, Cadmium, Hexavalent chromium, Polybrominated biphenyls (PBBs), Polybrominated diphenyl ethers (PBDEs), Bis(2-ethylhexyl) phthalate (DEHP), Butyl benzyl phthalate (BBP), Dibutyl phthalate (DBP) and Diisobutyl phthalate (DIBP)	PASS
Perfluorooctanoic acid (PFOA) and its salts & Perfluorooctane sulfonates (PFOS) and its derivatives	See Results

Signed for and on behalf of
 SGS-CSTC Standards Technical Services Co., Ltd. Guangzhou Branch

Dongyu Xie

Dongyu Xie
 Approved Signatory

scan to see the report



87F8007D



SGS-CSTC Standards Technical Services Co., Ltd.
 Guangzhou Branch Testing Center Chemical Laboratory

Unless otherwise agreed in writing, this document is issued by the Company subject to its General Conditions of Service printed overleaf, available on request or accessible at <http://www.sgs.com/en/Terms-and-Conditions.aspx> and, for electronic format documents, subject to Terms and Conditions for Electronic Documents at <http://www.sgs.com/en/Terms-and-Conditions/Terms-e-Document.aspx>. Attention is drawn to the limitation of liability, indemnification and jurisdiction issues defined therein. Any holder of this document is advised that information contained hereon reflects the Company's findings at the time of its intervention only and within the limits of Client's instructions, if any. The Company's sole responsibility is to its Client and this document does not exonerate parties to a transaction from exercising all their rights and obligations under the transaction documents. This document cannot be reproduced except in full, without prior written approval of the Company. Any unauthorized alteration, forgery or falsification of the content or appearance of this document is unlawful and offenders may be prosecuted to the fullest extent of the law. Unless otherwise stated the results shown in this test report refer only to the sample(s) tested.

Attention: To check the authenticity of testing /inspection report & certificate, please contact us at telephone: (86-755) 8307 1443, or email: CN.Doccheck@sgs.com

198 Kazhu Road, Sciotech Park Guangzhou Economic & Technology Development District, Guangzhou, China 510663

中国·广州·经济技术开发区科学城科珠路198号 邮编: 510663

t (86-20) 82155555 www.sgs.com.cn
 t (86-20) 82155555 sgs.china@sgs.com

Test Report

No. CANEC2218227003

Date: 30 Aug 2022

Page 2 of 8

Test Result(s) :

Test Part Description :

Specimen No.	SGS Sample ID	Description
SN1	CAN22-182270.003	Silver-gray plated metal

Remarks :

- (1) 1 mg/kg = 0.0001%
- (2) MDL = Method Detection Limit
- (3) ND = Not Detected (< MDL)
- (4) "-" = Not Regulated

EU RoHS Directive (EU) 2015/863 amending Annex II to Directive 2011/65/EU- Lead, Mercury, Cadmium, Hexavalent chromium, Polybrominated biphenyls (PBBs), Polybrominated diphenyl ethers (PBDEs), Bis(2-ethylhexyl) phthalate (DEHP), Butyl benzyl phthalate (BBP), Dibutyl phthalate (DBP) and Diisobutyl phthalate (DIBP)

Test Method : With reference to IEC 62321-4:2013+A1:2017, IEC 62321-5:2013, IEC 62321-7-1:2015 , IEC 62321-6:2015 and IEC 62321-8:2017, analyzed by ICP-OES , UV-Vis and GC-MS .

<u>Test Item(s)</u>	<u>Limit</u>	<u>Unit</u>	<u>MDL</u>	<u>003</u>
Cadmium (Cd)	100	mg/kg	2	ND
Lead (Pb)	1000	mg/kg	2	44
Mercury (Hg)	1000	mg/kg	2	ND
Hexavalent Chromium (Cr(VI))▼	-	µg/cm ²	0.10	ND
Sum of PBBs	1000	mg/kg	-	ND
Monobromobiphenyl	-	mg/kg	5	ND
Dibromobiphenyl	-	mg/kg	5	ND
Tribromobiphenyl	-	mg/kg	5	ND
Tetrabromobiphenyl	-	mg/kg	5	ND
Pentabromobiphenyl	-	mg/kg	5	ND
Hexabromobiphenyl	-	mg/kg	5	ND
Heptabromobiphenyl	-	mg/kg	5	ND
Octabromobiphenyl	-	mg/kg	5	ND
Nonabromobiphenyl	-	mg/kg	5	ND
Decabromobiphenyl	-	mg/kg	5	ND
Sum of PBDEs	1000	mg/kg	-	ND
Monobromodiphenyl ether	-	mg/kg	5	ND
Dibromodiphenyl ether	-	mg/kg	5	ND
Tribromodiphenyl ether	-	mg/kg	5	ND
Tetrabromodiphenyl ether	-	mg/kg	5	ND



Unless otherwise agreed in writing, this document is issued by the Company subject to its General Conditions of Service printed overleaf, available on request or accessible at <http://www.sgs.com/en/Terms-and-Conditions.aspx> and, for electronic format documents, subject to Terms and Conditions for Electronic Documents at <http://www.sgs.com/en/Terms-and-Conditions/Terms-e-Documents.aspx>. Attention is drawn to the limitation of liability, indemnification and jurisdiction issues defined therein. Any holder of this document is advised that information contained hereon reflects the Company's findings at the time of its intervention only and within the limits of Client's instructions, if any. The Company's sole responsibility is to its Client and this document does not exonerate parties to a transaction from exercising all their rights and obligations under the transaction documents. This document cannot be reproduced except in full, without prior written approval of the Company. Any unauthorized alteration, forgery or falsification of the content or appearance of this document is unlawful and offenders may be prosecuted to the fullest extent of the law. Unless otherwise stated the results shown in this test report refer only to the sample(s) tested.

Attention: To check the authenticity of testing /inspection report & certificate, please contact us at telephone: (86-755) 8307 1443, or email: CN.Doccheck@sgs.com

Test Report

No. CANEC2218227003

Date: 30 Aug 2022

Page 3 of 8

<u>Test Item(s)</u>	<u>Limit</u>	<u>Unit</u>	<u>MDL</u>	<u>003</u>
Pentabromodiphenyl ether	-	mg/kg	5	ND
Hexabromodiphenyl ether	-	mg/kg	5	ND
Heptabromodiphenyl ether	-	mg/kg	5	ND
Octabromodiphenyl ether	-	mg/kg	5	ND
Nonabromodiphenyl ether	-	mg/kg	5	ND
Decabromodiphenyl ether	-	mg/kg	5	ND
Dibutyl phthalate (DBP)	1000	mg/kg	50	ND
Butyl benzyl phthalate (BBP)	1000	mg/kg	50	ND
Bis (2-ethylhexyl) phthalate (DEHP)	1000	mg/kg	50	ND
Diisobutyl Phthalates (DIBP)	1000	mg/kg	50	ND

Notes :

- (1) The maximum permissible limit is quoted from RoHS Directive (EU) 2015/863.
- (2) IEC 62321 series is equivalent to EN 62321 series
- (3) ▼= a. The sample is positive for CrVI if the CrVI concentration is greater than 0.13 $\mu\text{g}/\text{cm}^2$. The sample coating is considered to contain CrVI
 b. The sample is negative for CrVI if CrVI is ND (concentration less than 0.10 $\mu\text{g}/\text{cm}^2$). The coating is considered a non-CrVI based coating
 c. The result between 0.10 $\mu\text{g}/\text{cm}^2$ and 0.13 $\mu\text{g}/\text{cm}^2$ is considered to be inconclusive - unavoidable coating variations may influence the determination
 Information on storage conditions and production date of the tested sample is unavailable and thus Cr(VI) results represent status of the sample at the time of testing.

Perfluorooctanoic acid (PFOA) and its salts & Perfluorooctane sulfonates (PFOS) and its derivatives

Test Method : With reference to CEN/TS15968:2010, analysis was performed by LC-MS or LC-MS/MS.

<u>Test Item(s)</u>	<u>CAS NO.</u>	<u>Unit</u>	<u>MDL</u>	<u>003</u>
Perfluorooctanoic acid (PFOA) and its salts+	335-67-1	mg/kg	0.010	ND
Perfluorooctane sulfonates (PFOS) ^	1763-23-1	mg/kg	0.010	ND
Perfluorooctane Sulfonamide (PFOSA)	754-91-6	mg/kg	0.010	ND
N-methylperfluoro-1-octanesulfonamide(MeFOSA)	31506-32-8	mg/kg	0.010	ND
N-ethylperfluoro-1-octanesulfonamide (EtFOSA)	4151-50-2	mg/kg	0.010	ND
2-(N-methylperfluoro-1-octanesulfonamido)-ethanol(MeFOSE)	24448-09-7	mg/kg	0.010	ND
2-(N-ethylperfluoro-1-octanesulfonamido)-ethanol(EtFOSE)	1691-99-2	mg/kg	0.010	ND
Perfluorooctane sulfonates (PFOS) and its derivatives	-	mg/kg	-	ND

Notes :



Unless otherwise agreed in writing, this document is issued by the Company subject to its General Conditions of Service printed overleaf, available on request or accessible at <http://www.sgs.com/en/Terms-and-Conditions.aspx> and, for electronic format documents, subject to Terms and Conditions for Electronic Documents at <http://www.sgs.com/en/Terms-and-Conditions/Terms-e-Document.aspx>. Attention is drawn to the limitation of liability, indemnification and jurisdiction issues defined therein. Any holder of this document is advised that information contained hereon reflects the Company's findings at the time of its intervention only and within the limits of Client's instructions, if any. The Company's sole responsibility is to its Client and this document does not exonerate parties to a transaction from exercising all their rights and obligations under the transaction documents. This document cannot be reproduced except in full, without prior written approval of the Company. Any unauthorized alteration, forgery or falsification of the content or appearance of this document is unlawful and offenders may be prosecuted to the fullest extent of the law. Unless otherwise stated the results shown in this test report refer only to the sample(s) tested.

Attention: To check the authenticity of testing /inspection report & certificate, please contact us at telephone: (86-755) 8307 1443, or email: CN.Doccheck@sgs.com

- (1) + PFOA and its salts including PFOA-Na (CAS No.: 335-95-5), PFOA-K (CAS No.: 2395-00-8), PFOA-Ag (CAS No.: 335-93-3), PFOA-F (CAS No.: 335-66-0) and APFO (CAS No.: 3825-26-1);
 (2) ^ PFOS including PFOS-K (CAS No.: 2795-39-3), PFOS-Li (CAS No.: 29457-72-5), PFOS-NH₄ (CAS No.: 29081-56-9), PFOS-NH(OH)₂ (CAS No.: 70225-14-8), PFOS-N(C₂H₅)₄ (CAS No.: 56773-42-3), PFOS-DDA(CAS No.:251099-16-8) and POSF (CAS No.: 307-35-7)

Unless otherwise stated, the decision rule for conformity reporting is based on Binary Statement for Simple Acceptance Rule ($w=0$) stated in ILAC-G8:09/2019.



Unless otherwise agreed in writing, this document is issued by the Company subject to its General Conditions of Service printed overleaf, available on request or accessible at <http://www.sgs.com/en/Terms-and-Conditions.aspx> and, for electronic format documents, subject to Terms and Conditions for Electronic Documents at <http://www.sgs.com/en/Terms-and-Conditions/Terms-e-Documents.aspx>. Attention is drawn to the limitation of liability, indemnification and jurisdiction issues defined therein. Any holder of this document is advised that information contained hereon reflects the Company's findings at the time of its intervention only and within the limits of Client's instructions, if any. The Company's sole responsibility is to its Client and this document does not exonerate parties to a transaction from exercising all their rights and obligations under the transaction documents. This document cannot be reproduced except in full, without prior written approval of the Company. Any unauthorized alteration, forgery or falsification of the content or appearance of this document is unlawful and offenders may be prosecuted to the fullest extent of the law. Unless otherwise stated the results shown in this test report refer only to the sample(s) tested.

Attention: To check the authenticity of testing / inspection report & certificate, please contact us at telephone: (86-755) 8307 1443, or email: CN.Doccheck@sgs.com

ATTACHMENTS

Pb/Cd/Hg/Cr⁶⁺/PBBs/PBDEs Testing Flow Chart

1) These samples were dissolved totally by pre-conditioning method according to below flow chart. (Cr⁶⁺ and PBBs/PBDEs test method excluded).

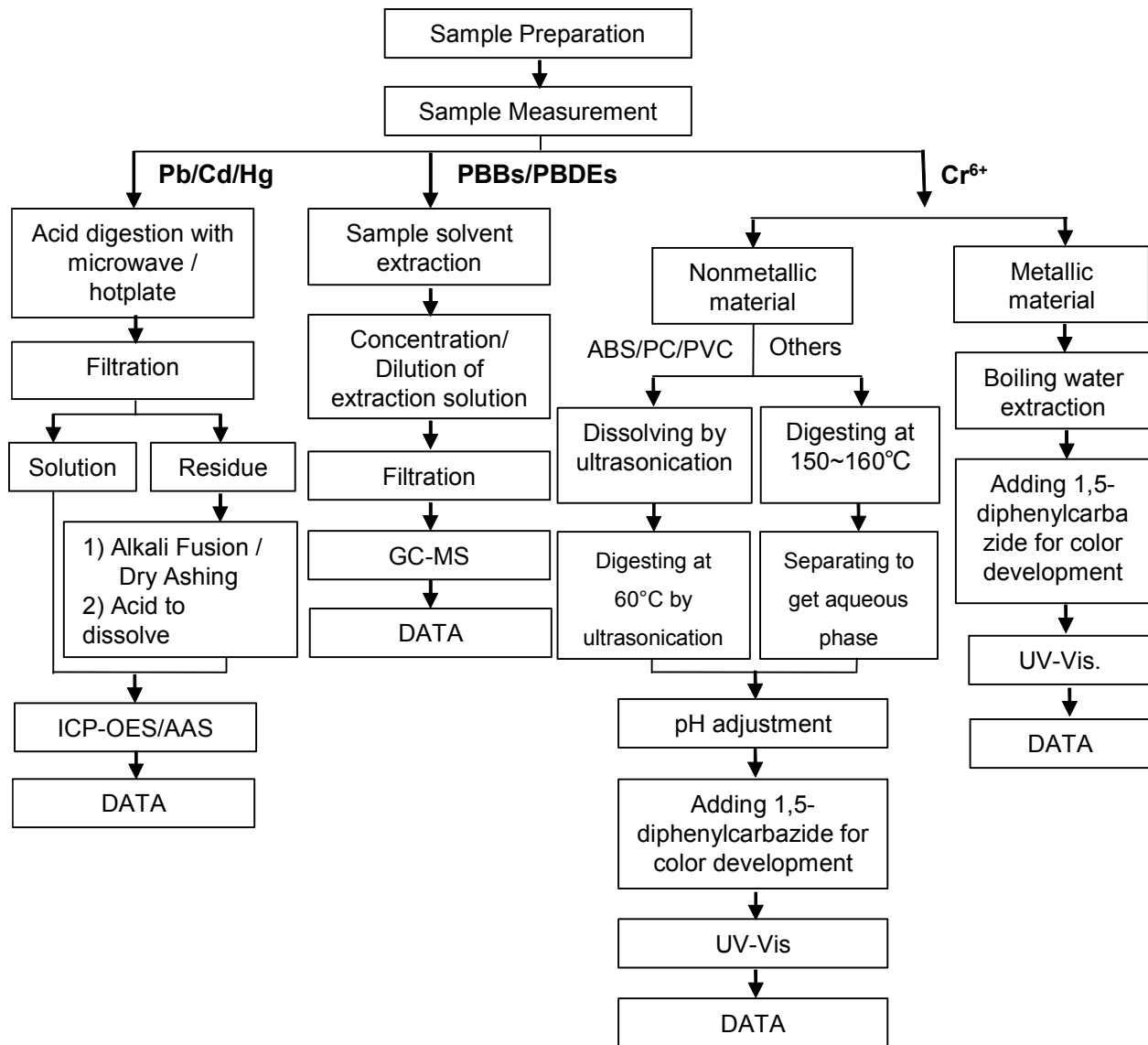

ATTACHMENTS

Phthalates Testing Flow Chart

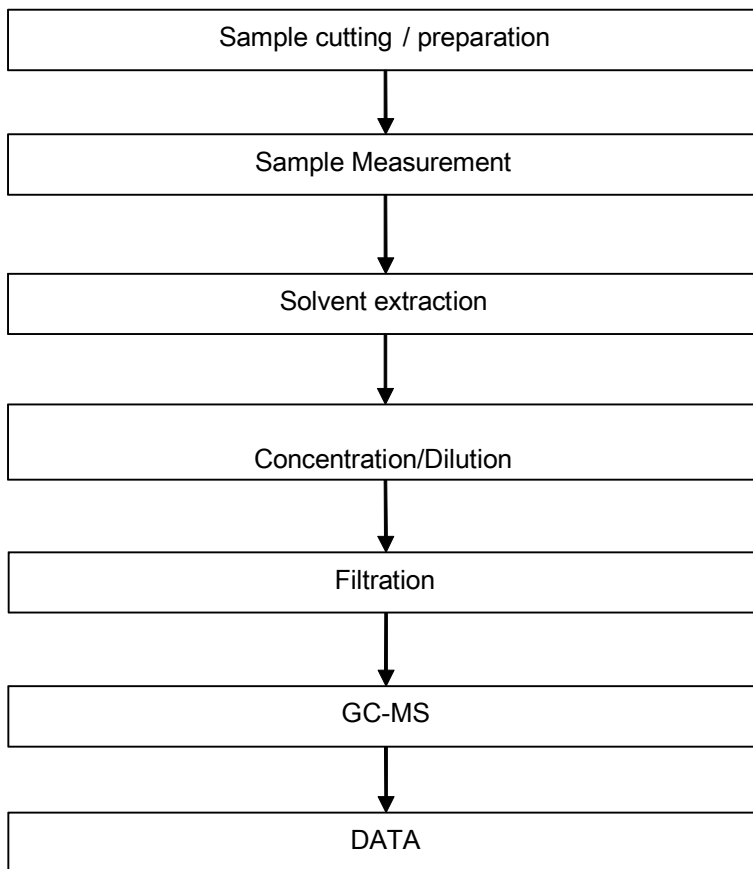

Unless otherwise agreed in writing, this document is issued by the Company subject to its General Conditions of Service printed overleaf, available on request or accessible at <http://www.sgs.com/en/Terms-and-Conditions.aspx> and, for electronic format documents, subject to Terms and Conditions for Electronic Documents at <http://www.sgs.com/en/Terms-and-Conditions/Terms-e-Document.aspx>. Attention is drawn to the limitation of liability, indemnification and jurisdiction issues defined therein. Any holder of this document is advised that information contained hereon reflects the Company's findings at the time of its intervention only and within the limits of Client's instructions, if any. The Company's sole responsibility is to its Client and this document does not exonerate parties to a transaction from exercising all their rights and obligations under the transaction documents. This document cannot be reproduced except in full, without prior written approval of the Company. Any unauthorized alteration, forgery or falsification of the content or appearance of this document is unlawful and offenders may be prosecuted to the fullest extent of the law. Unless otherwise stated the results shown in this test report refer only to the sample(s) tested.

Attention: To check the authenticity of testing / inspection report & certificate, please contact us at telephone: (86-755) 8307 1443, or email: CN_Doccheck@sgs.com

ATTACHMENTS

PFOA / PFOS Testing Flow Chart

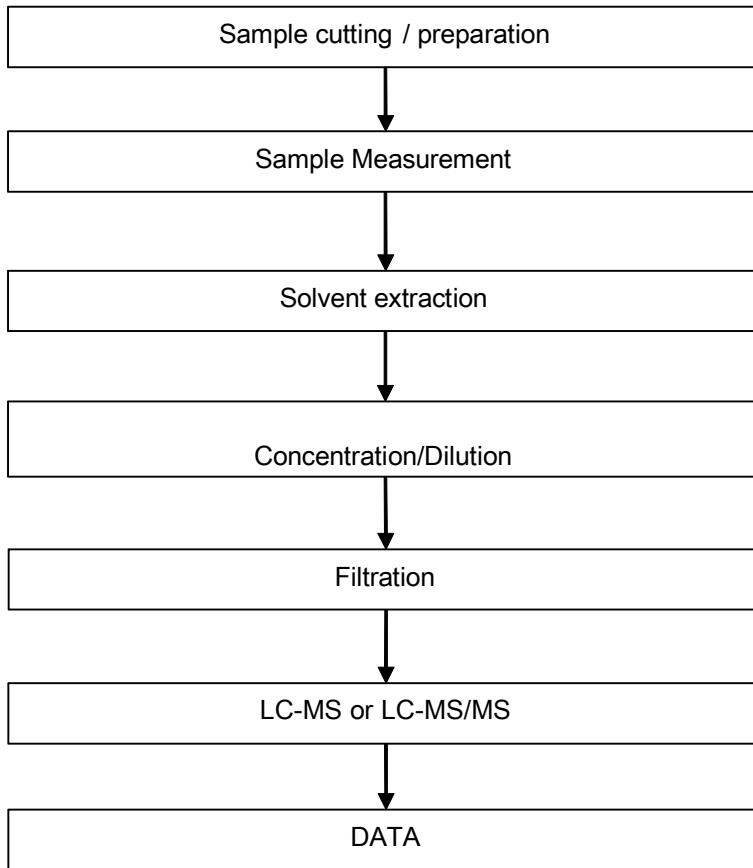

Unless otherwise agreed in writing, this document is issued by the Company subject to its General Conditions of Service printed overleaf, available on request or accessible at <http://www.sgs.com/en/Terms-and-Conditions.aspx> and, for electronic format documents, subject to Terms and Conditions for Electronic Documents at <http://www.sgs.com/en/Terms-and-Conditions/Terms-e-Document.aspx>. Attention is drawn to the limitation of liability, indemnification and jurisdiction issues defined therein. Any holder of this document is advised that information contained hereon reflects the Company's findings at the time of its intervention only and within the limits of Client's instructions, if any. The Company's sole responsibility is to its Client and this document does not exonerate parties to a transaction from exercising all their rights and obligations under the transaction documents. This document cannot be reproduced except in full, without prior written approval of the Company. Any unauthorized alteration, forgery or falsification of the content or appearance of this document is unlawful and offenders may be prosecuted to the fullest extent of the law. Unless otherwise stated the results shown in this test report refer only to the sample(s) tested.

Attention: To check the authenticity of testing / inspection report & certificate, please contact us at telephone: (86-755) 8307 1443, or email: CN_Doccheck@sgs.com

Sample photo:



SGS authenticate the photo on original report only

*** End of Report ***



Test Report

No. CANEC2218227002

Date: 30 Aug 2022

Page 1 of 8

Client Name : SHENZHEN CITY TONGHUA INDUSTRY CO.,LTD

Client Address : TONGHUA MANSIN TONGLE XINBU VILLANG TOWN SHENZHEN CITY CHINA

Sample Name : Gold (AU)

The above sample(s) and information were provided by the client.

SGS Job No. : CP22-047169 - SZ
 Date of Sample Received : 25 Aug 2022
 Testing Period : 25 Aug 2022 - 30 Aug 2022
 Test Requested : Selected test(s) as requested by the client.
 Test Method(s) : Please refer to next page(s).
 Test Result(s) : Please refer to next page(s).

Result Summary :

Test Requested	Conclusion
EU RoHS Directive (EU) 2015/863 amending Annex II to Directive 2011/65/EU- Lead, Mercury, Cadmium, Hexavalent chromium, Polybrominated biphenyls (PBBs), Polybrominated diphenyl ethers (PBDEs), Bis(2-ethylhexyl) phthalate (DEHP), Butyl benzyl phthalate (BBP), Dibutyl phthalate (DBP) and Diisobutyl phthalate (DIBP)	PASS
Perfluorooctanoic acid (PFOA) and its salts & Perfluorooctane sulfonates (PFOS) and its derivatives	See Results

Signed for and on behalf of
 SGS-CSTC Standards Technical Services Co., Ltd. Guangzhou Branch

Dongyu Xie

Dongyu Xie
 Approved Signatory

scan to see the report



9B230D54



Unless otherwise agreed in writing, this document is issued by the Company subject to its General Conditions of Service printed overleaf, available on request or accessible at <http://www.sgs.com/en/Terms-and-Conditions.aspx> and, for electronic format documents, subject to Terms and Conditions for Electronic Documents at <http://www.sgs.com/en/Terms-and-Conditions/Terms-e-Document.aspx>. Attention is drawn to the limitation of liability, indemnification and jurisdiction issues defined therein. Any holder of this document is advised that information contained hereon reflects the Company's findings at the time of its intervention only and within the limits of Client's instructions, if any. The Company's sole responsibility is to its Client and this document does not exonerate parties to a transaction from exercising all their rights and obligations under the transaction documents. This document cannot be reproduced except in full, without prior written approval of the Company. Any unauthorized alteration, forgery or falsification of the content or appearance of this document is unlawful and offenders may be prosecuted to the fullest extent of the law. Unless otherwise stated the results shown in this test report refer only to the sample(s) tested.

Attention: To check the authenticity of testing /inspection report & certificate, please contact us at telephone: (86-755) 8307 1443, or email: CN.Doccheck@sgs.com

Test Report

No. CANEC2218227002

Date: 30 Aug 2022

Page 2 of 8

Test Result(s) :

Test Part Description :

Specimen No.	SGS Sample ID	Description
SN1	CAN22-182270.002	Gold plated metal

Remarks :

- (1) 1 mg/kg = 0.0001%
- (2) MDL = Method Detection Limit
- (3) ND = Not Detected (< MDL)
- (4) "-" = Not Regulated

EU RoHS Directive (EU) 2015/863 amending Annex II to Directive 2011/65/EU- Lead, Mercury, Cadmium, Hexavalent chromium, Polybrominated biphenyls (PBBs), Polybrominated diphenyl ethers (PBDEs), Bis(2-ethylhexyl) phthalate (DEHP), Butyl benzyl phthalate (BBP), Dibutyl phthalate (DBP) and Diisobutyl phthalate (DIBP)

Test Method : With reference to IEC 62321-4:2013+A1:2017, IEC 62321-5:2013, IEC 62321-7-1:2015 , IEC 62321-6:2015 and IEC 62321-8:2017, analyzed by ICP-OES , UV-Vis and GC-MS .

<u>Test Item(s)</u>	<u>Limit</u>	<u>Unit</u>	<u>MDL</u>	<u>002</u>
Cadmium (Cd)	100	mg/kg	2	ND
Lead (Pb)	1000	mg/kg	2	50
Mercury (Hg)	1000	mg/kg	2	ND
Hexavalent Chromium (Cr(VI))▼	-	µg/cm ²	0.10	ND
Sum of PBBs	1000	mg/kg	-	ND
Monobromobiphenyl	-	mg/kg	5	ND
Dibromobiphenyl	-	mg/kg	5	ND
Tribromobiphenyl	-	mg/kg	5	ND
Tetrabromobiphenyl	-	mg/kg	5	ND
Pentabromobiphenyl	-	mg/kg	5	ND
Hexabromobiphenyl	-	mg/kg	5	ND
Heptabromobiphenyl	-	mg/kg	5	ND
Octabromobiphenyl	-	mg/kg	5	ND
Nonabromobiphenyl	-	mg/kg	5	ND
Decabromobiphenyl	-	mg/kg	5	ND
Sum of PBDEs	1000	mg/kg	-	ND
Monobromodiphenyl ether	-	mg/kg	5	ND
Dibromodiphenyl ether	-	mg/kg	5	ND
Tribromodiphenyl ether	-	mg/kg	5	ND
Tetrabromodiphenyl ether	-	mg/kg	5	ND



Unless otherwise agreed in writing, this document is issued by the Company subject to its General Conditions of Service printed overleaf, available on request or accessible at <http://www.sgs.com/en/Terms-and-Conditions.aspx> and, for electronic format documents, subject to Terms and Conditions for Electronic Documents at <http://www.sgs.com/en/Terms-and-Conditions/Terms-e-Document.aspx>. Attention is drawn to the limitation of liability, indemnification and jurisdiction issues defined therein. Any holder of this document is advised that information contained hereon reflects the Company's findings at the time of its intervention only and within the limits of Client's instructions, if any. The Company's sole responsibility is to its Client and this document does not exonerate parties to a transaction from exercising all their rights and obligations under the transaction documents. This document cannot be reproduced except in full, without prior written approval of the Company. Any unauthorized alteration, forgery or falsification of the content or appearance of this document is unlawful and offenders may be prosecuted to the fullest extent of the law. Unless otherwise stated the results shown in this test report refer only to the sample(s) tested.

Attention: To check the authenticity of testing /inspection report & certificate, please contact us at telephone: (86-755) 8307 1443, or email: CN.Doccheck@sgs.com

Test Report

No. CANEC2218227002

Date: 30 Aug 2022

Page 3 of 8

<u>Test Item(s)</u>	<u>Limit</u>	<u>Unit</u>	<u>MDL</u>	<u>002</u>
Pentabromodiphenyl ether	-	mg/kg	5	ND
Hexabromodiphenyl ether	-	mg/kg	5	ND
Heptabromodiphenyl ether	-	mg/kg	5	ND
Octabromodiphenyl ether	-	mg/kg	5	ND
Nonabromodiphenyl ether	-	mg/kg	5	ND
Decabromodiphenyl ether	-	mg/kg	5	ND
Dibutyl phthalate (DBP)	1000	mg/kg	50	ND
Butyl benzyl phthalate (BBP)	1000	mg/kg	50	ND
Bis (2-ethylhexyl) phthalate (DEHP)	1000	mg/kg	50	ND
Diisobutyl Phthalates (DIBP)	1000	mg/kg	50	ND

Notes :

- (1) The maximum permissible limit is quoted from RoHS Directive (EU) 2015/863.
- (2) IEC 62321 series is equivalent to EN 62321 series
- (3) ▼= a. The sample is positive for CrVI if the CrVI concentration is greater than 0.13 $\mu\text{g}/\text{cm}^2$. The sample coating is considered to contain CrVI
 b. The sample is negative for CrVI if CrVI is ND (concentration less than 0.10 $\mu\text{g}/\text{cm}^2$). The coating is considered a non-CrVI based coating
 c. The result between 0.10 $\mu\text{g}/\text{cm}^2$ and 0.13 $\mu\text{g}/\text{cm}^2$ is considered to be inconclusive - unavoidable coating variations may influence the determination
 Information on storage conditions and production date of the tested sample is unavailable and thus Cr(VI) results represent status of the sample at the time of testing.

Perfluorooctanoic acid (PFOA) and its salts & Perfluorooctane sulfonates (PFOS) and its derivatives

Test Method : With reference to CEN/TS15968:2010, analysis was performed by LC-MS or LC-MS/MS.

<u>Test Item(s)</u>	<u>CAS NO.</u>	<u>Unit</u>	<u>MDL</u>	<u>002</u>
Perfluorooctanoic acid (PFOA) and its salts+	335-67-1	mg/kg	0.010	ND
Perfluorooctane sulfonates (PFOS) ^	1763-23-1	mg/kg	0.010	ND
Perfluorooctane Sulfonamide (PFOSA)	754-91-6	mg/kg	0.010	ND
N-methylperfluoro-1-octanesulfonamide(MeFOSA)	31506-32-8	mg/kg	0.010	ND
N-ethylperfluoro-1-octanesulfonamide (EtFOSA)	4151-50-2	mg/kg	0.010	ND
2-(N-methylperfluoro-1-octanesulfonamido)-ethanol(MeFOSE)	24448-09-7	mg/kg	0.010	ND
2-(N-ethylperfluoro-1-octanesulfonamido)-ethanol(EtFOSE)	1691-99-2	mg/kg	0.010	ND
Perfluorooctane sulfonates (PFOS) and its derivatives	-	mg/kg	-	ND

Notes :



Unless otherwise agreed in writing, this document is issued by the Company subject to its General Conditions of Service printed overleaf, available on request or accessible at <http://www.sgs.com/en/Terms-and-Conditions.aspx> and, for electronic format documents, subject to Terms and Conditions for Electronic Documents at <http://www.sgs.com/en/Terms-and-Conditions/Terms-e-Documents.aspx>. Attention is drawn to the limitation of liability, indemnification and jurisdiction issues defined therein. Any holder of this document is advised that information contained hereon reflects the Company's findings at the time of its intervention only and within the limits of Client's instructions, if any. The Company's sole responsibility is to its Client and this document does not exonerate parties to a transaction from exercising all their rights and obligations under the transaction documents. This document cannot be reproduced except in full, without prior written approval of the Company. Any unauthorized alteration, forgery or falsification of the content or appearance of this document is unlawful and offenders may be prosecuted to the fullest extent of the law. Unless otherwise stated the results shown in this test report refer only to the sample(s) tested.

Attention: To check the authenticity of testing /inspection report & certificate, please contact us at telephone: (86-755) 8307 1443, or email: CN.Doccheck@sgs.com

- (1) + PFOA and its salts including PFOA-Na (CAS No.: 335-95-5), PFOA-K (CAS No.: 2395-00-8), PFOA-Ag (CAS No.: 335-93-3), PFOA-F (CAS No.: 335-66-0) and APFO (CAS No.: 3825-26-1);
- (2) ^ PFOS including PFOS-K (CAS No.: 2795-39-3), PFOS-Li (CAS No.: 29457-72-5), PFOS-NH₄ (CAS No.: 29081-56-9), PFOS-NH(OH)₂ (CAS No.: 70225-14-8), PFOS-N(C₂H₅)₄ (CAS No.: 56773-42-3), PFOS-DDA(CAS No.:251099-16-8) and POSF (CAS No.: 307-35-7)

Unless otherwise stated, the decision rule for conformity reporting is based on Binary Statement for Simple Acceptance Rule ($w=0$) stated in ILAC-G8:09/2019.



Unless otherwise agreed in writing, this document is issued by the Company subject to its General Conditions of Service printed overleaf, available on request or accessible at <http://www.sgs.com/en/Terms-and-Conditions.aspx> and, for electronic format documents, subject to Terms and Conditions for Electronic Documents at <http://www.sgs.com/en/Terms-and-Conditions/Terms-e-Documents.aspx>. Attention is drawn to the limitation of liability, indemnification and jurisdiction issues defined therein. Any holder of this document is advised that information contained hereon reflects the Company's findings at the time of its intervention only and within the limits of Client's instructions, if any. The Company's sole responsibility is to its Client and this document does not exonerate parties to a transaction from exercising all their rights and obligations under the transaction documents. This document cannot be reproduced except in full, without prior written approval of the Company. Any unauthorized alteration, forgery or falsification of the content or appearance of this document is unlawful and offenders may be prosecuted to the fullest extent of the law. Unless otherwise stated the results shown in this test report refer only to the sample(s) tested.

Attention: To check the authenticity of testing /inspection report & certificate, please contact us at telephone: (86-755) 8307 1443, or email: CN.Doccheck@sgs.com

ATTACHMENTS

Pb/Cd/Hg/Cr⁶⁺/PBBs/PBDEs Testing Flow Chart

1) These samples were dissolved totally by pre-conditioning method according to below flow chart. (Cr⁶⁺ and PBBs/PBDEs test method excluded).

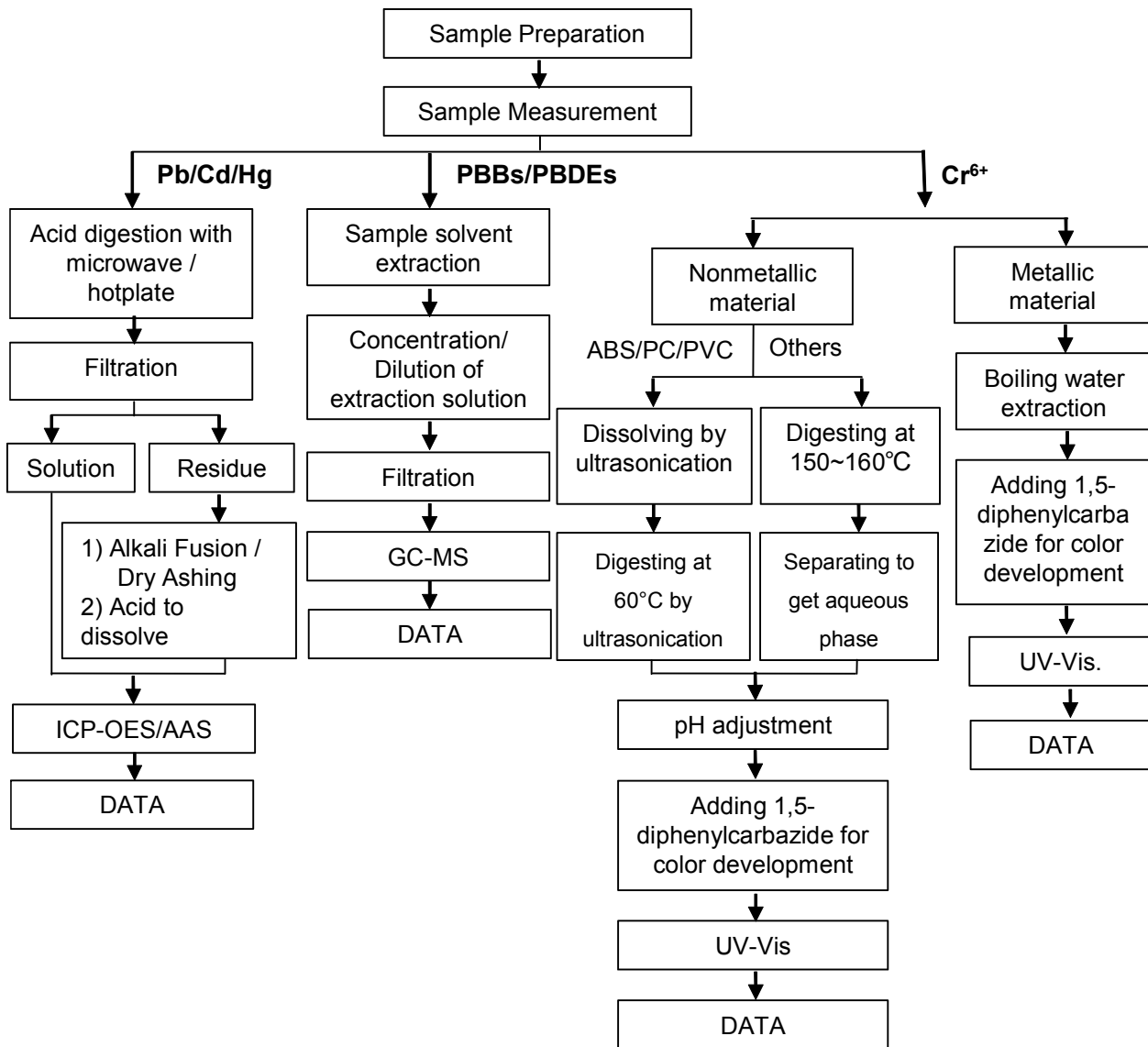

Unless otherwise agreed in writing, this document is issued by the Company subject to its General Conditions of Service printed overleaf, available on request or accessible at <http://www.sgs.com/en/Terms-and-Conditions.aspx> and, for electronic format documents, subject to Terms and Conditions for Electronic Documents at <http://www.sgs.com/en/Terms-and-Conditions/Terms-e-Documents.aspx>. Attention is drawn to the limitation of liability, indemnification and jurisdiction issues defined therein. Any holder of this document is advised that information contained hereon reflects the Company's findings at the time of its intervention only and within the limits of Client's instructions, if any. The Company's sole responsibility is to its Client and this document does not exonerate parties to a transaction from exercising all their rights and obligations under the transaction documents. This document cannot be reproduced except in full, without prior written approval of the Company. Any unauthorized alteration, forgery or falsification of the content or appearance of this document is unlawful and offenders may be prosecuted to the fullest extent of the law. Unless otherwise stated the results shown in this test report refer only to the sample(s) tested.

Attention: To check the authenticity of testing / inspection report & certificate, please contact us at telephone: (86-755) 8307 1443, or email: CN.Doccheck@sgs.com

ATTACHMENTS

Phthalates Testing Flow Chart

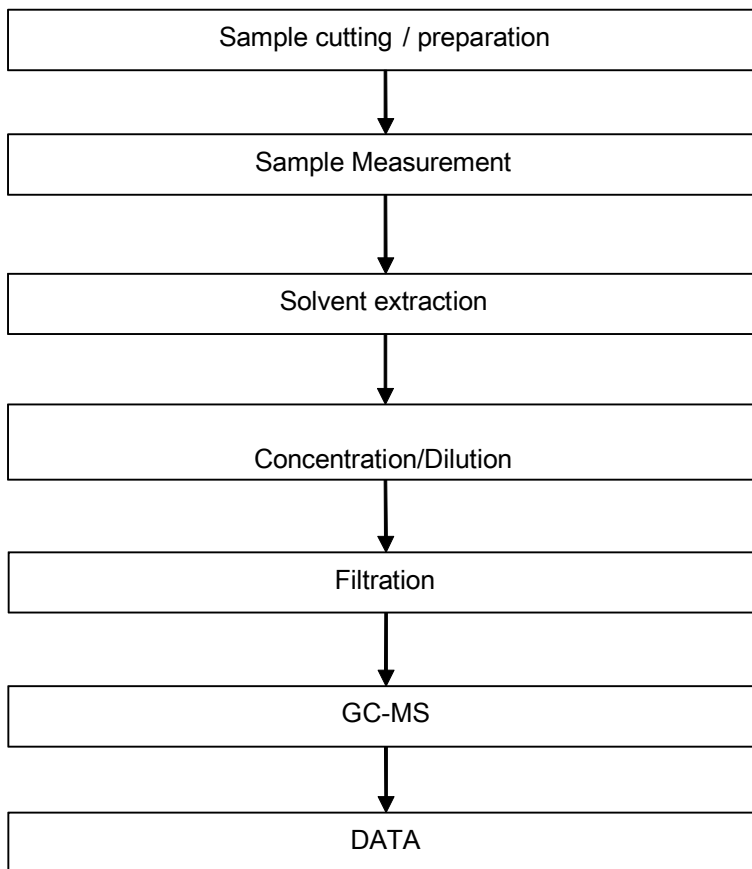

Unless otherwise agreed in writing, this document is issued by the Company subject to its General Conditions of Service printed overleaf, available on request or accessible at <http://www.sgs.com/en/Terms-and-Conditions.aspx> and, for electronic format documents, subject to Terms and Conditions for Electronic Documents at <http://www.sgs.com/en/Terms-and-Conditions/Terms-e-Document.aspx>. Attention is drawn to the limitation of liability, indemnification and jurisdiction issues defined therein. Any holder of this document is advised that information contained hereon reflects the Company's findings at the time of its intervention only and within the limits of Client's instructions, if any. The Company's sole responsibility is to its Client and this document does not exonerate parties to a transaction from exercising all their rights and obligations under the transaction documents. This document cannot be reproduced except in full, without prior written approval of the Company. Any unauthorized alteration, forgery or falsification of the content or appearance of this document is unlawful and offenders may be prosecuted to the fullest extent of the law. Unless otherwise stated the results shown in this test report refer only to the sample(s) tested.

Attention: To check the authenticity of testing / inspection report & certificate, please contact us at telephone: (86-755) 8307 1443, or email: CN_Doccheck@sgs.com

ATTACHMENTS

PFOA / PFOS Testing Flow Chart

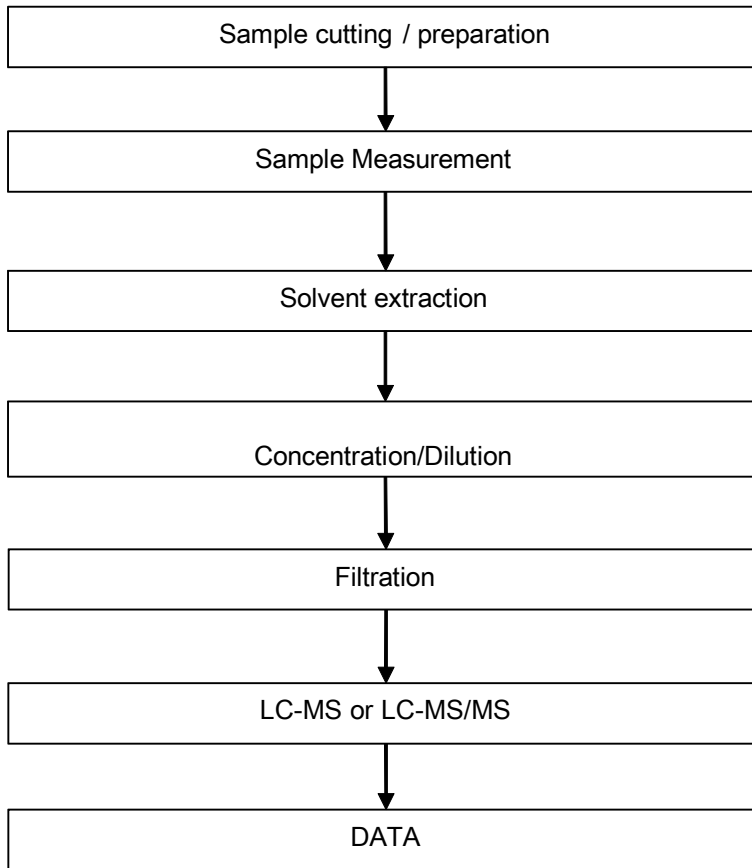

Unless otherwise agreed in writing, this document is issued by the Company subject to its General Conditions of Service printed overleaf, available on request or accessible at <http://www.sgs.com/en/Terms-and-Conditions.aspx> and, for electronic format documents, subject to Terms and Conditions for Electronic Documents at <http://www.sgs.com/en/Terms-and-Conditions/Terms-e-Document.aspx>. Attention is drawn to the limitation of liability, indemnification and jurisdiction issues defined therein. Any holder of this document is advised that information contained hereon reflects the Company's findings at the time of its intervention only and within the limits of Client's instructions, if any. The Company's sole responsibility is to its Client and this document does not exonerate parties to a transaction from exercising all their rights and obligations under the transaction documents. This document cannot be reproduced except in full, without prior written approval of the Company. Any unauthorized alteration, forgery or falsification of the content or appearance of this document is unlawful and offenders may be prosecuted to the fullest extent of the law. Unless otherwise stated the results shown in this test report refer only to the sample(s) tested.

Attention: To check the authenticity of testing / inspection report & certificate, please contact us at telephone: (86-755) 8307 1443, or email: CN_Doccheck@sgs.com

Sample photo:



SGS authenticate the photo on original report only

*** End of Report ***

