

承 认 书

Approval Sheet

客户 (Customer): /

客户料号 (Cus .P/N): /

华联威料号 (HLW P/N): JK1-208-G717

品名规格 (PronameSpec): 耳机 音频母座

送样日期 (Delivery Date): 2022/06/23

承认日期 (Acknowledge Date): 2022/06/23

Approved No:		客 户 Customer	
采 购 部 Purchasing Dept	品 质 部 QC Dept	工 程 部 Engineering Dept	确 认 Approved By
深 圳 市 华 联 威 电 子 科 技 有 限 公 司 SHEN ZHEN SHI HUA LIAN WEI ELECTRONICS TECHNOLOGY CO; LTD.			
业 务 部 Sales Dept	品 管 部 QC Dept	工 程 部 Engineering Dept	核 准 Checked By
蒋成英	欠必峰	覃裕华	唐竹君

地址: 深圳市龙华区观澜街道桂香社区观澜桂花路 307 号

TEL: 0755-28888886 28888866

hua@hlwconn.com

[Http://www.hlwconn.com](http://www.hlwconn.com)

目 录

Contents

图纸.....	Page03
产品规格书.....	Page04-06
产品检测报告.....	Page07-08
尺寸测试报告.....	Page09
电镀报告.....	Page10
盐雾报告.....	Page11
材质证明.....	Page12
SGS.....	Page13-32

REV.	ECN.NO.	APPD.
A	XXXXXXXXXX	yangguifeng

技术要求:
 使用温度范围: -40℃~70℃
 额定负荷: DC50V 0.2A
 接触电阻: ≤0.03Ω
 绝缘电阻: ≥100MΩDC500V
 耐压: AC500V(50HZ)/min
 插拔力: 3~25N
 寿命: 10000次

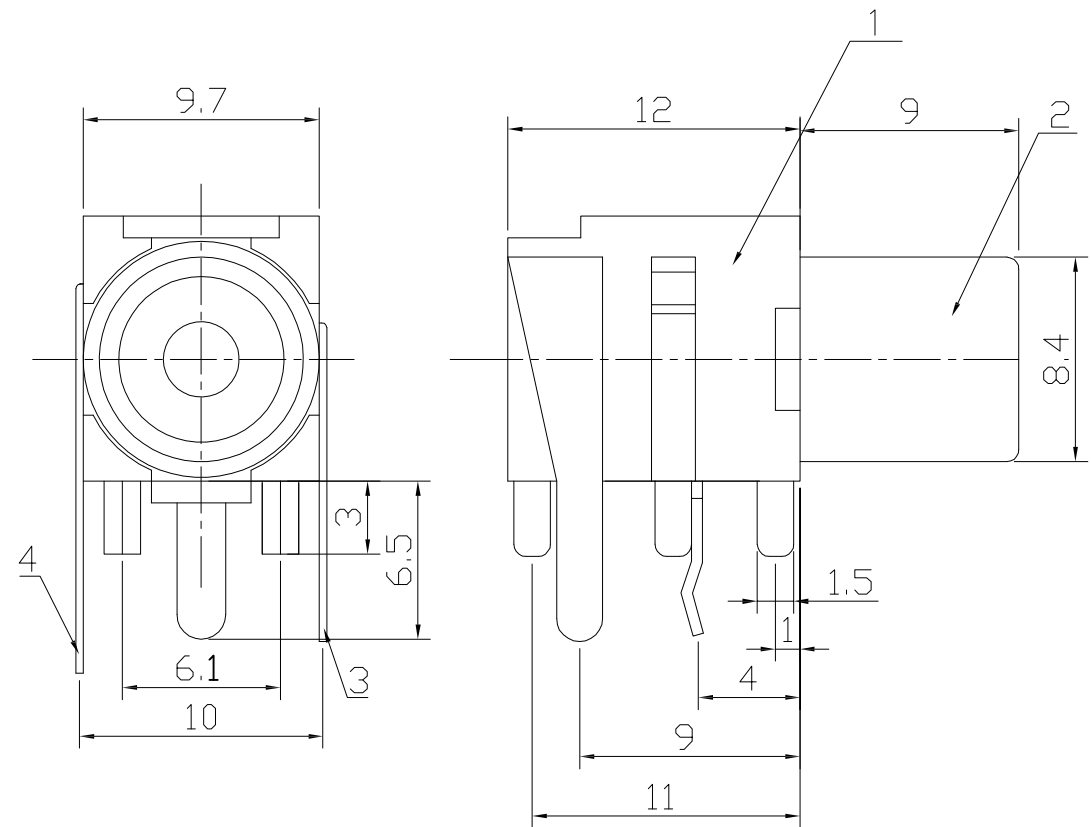

4	插针	1	磷铜 t=0.3
3	插针	1	H62 黄铜 t=0.4
2	铜套	1	H62 黄铜 t=0.35
1	基座	1	ABS
序号	部件名称	数量	材料

JK1-208-XXX7

- 1: 半金1u"
- 3: 半金3u"
- 5: 半金5u"
- G: 半金G/Fu"
- 9: 镀全金1u"
- 4: 镀全亮锡
- 1: PA66
- 2: PBT
- 7: ABS
- 1: 黑色
- 2: 白色
- 3: 米黄色

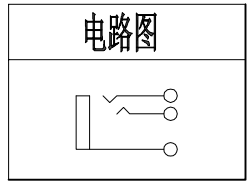
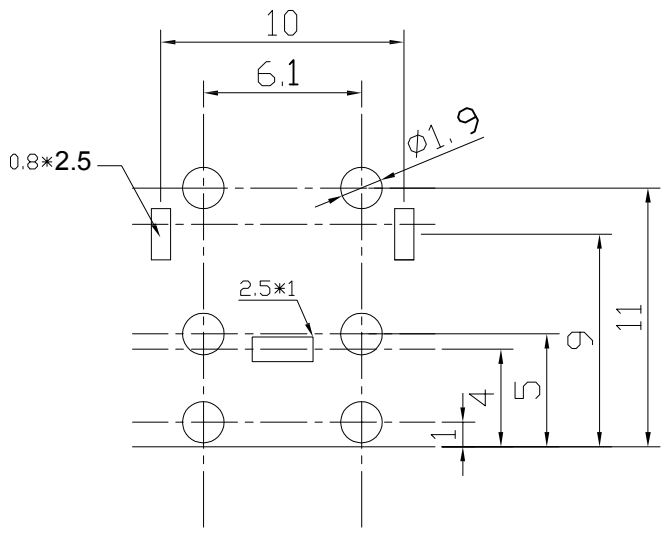

TOLERANCE UNLESS OTHERWISE SPECIFIED		FLW 深圳市华联威电子科技有限公司				
.XXX ±0.10		HUA LIAN WEI TECHNOLOGY ELECTRONICS CO.;LTD.				
.XX ±0.20						
.X ±0.30						
APPROVED		PART NAME:	音频母座			
CHECKED		PART No:	JK1-208-G717			C
DRAWN	yangguifeng	PROJECTION:	UNIT:	SCALE	SHEET	REV.
DATE	2021.12.01		mm	1:1	1 OF 1	A

JACK系列產品SPEC

TEST ITEM		REQUIREMENT	PROCEDURE
1	Examination of Product	Meets requirements of product drawing. No physical damage.	Visual inspection.
2	Operating Temperature	-25°C to 85 °C	
3	Storage Temperature	-25°C to 85 °C	
ELECTRICAL REQUIREMENT			
4	Rating Voltage	12VAC max	on any signal pin with respect to the shield
5	Rating Current	1.0 A per contact	55°C ,maximum ambient 85°C ,maximum temperature change (ANSI/EIA 364-70,TP-70)
6	Contact Resistance	[50] m Ohm Max	Subject mated contacts assembled in housing to 20mV Max open circuit at 100mA Max. EIA-364-23.
7	Dielectric withstanding Voltage	No flashover ,no creeping discharge, no breakdown	500 VAC for 1 minute between adjacent terminals. EIA 364-20
8	Insulation Resistance	[100] M Ohm Min.	Mated connector with a voltage of 500V DC for 1 minutes between adjacent terminals EIA 364-21
9	Temperature Rising	30°C Max. Under loaded rating current	Contact series-wired, apply test current of loaded rating current to the circuit, and measure the temperature rising by probing on soldered areas of contacts, after the temperature becomes stabilized deduct ambient temperature from the measured value.
Mechanical Requirement			
10	Connector Mating Force	<u>3.0 kgf Max</u>	Mating the connector with standard audio plug at a rate of 12.7 mm per minute EIA 364-13
11	Connector Unmating Force	<u>0.30~3.0 kgf</u>	Unmating the connector with standard audio plug at a rate of 12.7 mm per minute EIA 364-13

12	Durability	Visual Inspection-No physical damage LLCR-50 mΩ max per contact initial,100 mΩ after 1500 insertions.	Insertion and extraction with plug up to 1500 cycles at a maximum rate of 200 cycles per hour. EIA 364-09
13	Vibration	No discontinuity at 1 μ s or longer(each contact) when continuity is tested per ANSI/EIA-364-46	ANSI/EIA-364-28,Condition III,Method 5A,15 minute/axis
14	Mechanical Shock	No discontinuity at 1 μ s or longer(each contact) when continuity is tested per ANSI/EIA-364-46	ANSI/EIA-364-27 Condition A(specified pulse)
15	Solder ability	At least 95% of the immersed area shall be covered with new solder	1)Temperature of fused solder: 260+5 °C. 2)Dipping time:5+0.5s EIA 364-52
Environmental Requirements			
16	Resistance to Solder Heat	Forming resin shall not be distorted, and terminations shall not be separated.	1) Depth of dipping termination: the distance between the mounting surface and solder surface shall be 1 mm to 2mm. 2)Temperature:245+5°C . 3) Dipping time:10+1s EIA 364-52
17	Thermal Shock	No physical damage to the samples and LLCR-50 mΩ max per contact	Mated connectors exposed to 10 cycles between - 55°C to 85°C, 30 minutes duration at both temperature extremes EIA 364-28
18	Steady State Humidity	No physical damage to the samples and can pass the Dielectric Withstanding Voltage & Insulation Resistance	Expose mated connectors to a temperature of 40±2°C with relative humidity of 90-95% for 168 hours Min(seven complete cycles). Remove surface moisture and air dry for 24 hours EIA 364-28
19	Temperature Life (Heat Aging)	[100] M Ohm Min. (insulation reisistance)	ANSI/EIA-364-17 Condition 4 105°C for 250 hours,Method A,mated
20	Salt Spray	Visual Inspection-No physical damageLLCR-50 mΩ max per contact	Mated connector expose to 5% salt concentration for 12 hours at temperature 35+2°C .After the test specimens shall be washed with running water and dried
21	Colour	Colour Atla	284C(Blue) 577C(Green) 701C(Red)
22	Plating	Contact: <u>Cu:40u" ,Sn:40u" ,Ni:40u"</u> Shell: <u>Cu:40u" ,Ni:40u"</u> Ground: <u>Cu:40u" ,Ni:40u" ,Sn:40u"</u>	/
Product Qualification and Requalification test			
Test Group			

Test or Examination	A	B	C	D	E	F	G	H	I	J
	Test Sequence (a)									
Examination of Product	1, 7	1, 9	1, 6	1, 5	1, 5	1, 5	1, 5	1, 3	1, 3	1, 3
Contact Resistance		2, 8	2, 5	2, 4	2, 4	2, 4	2, 4			
Dielectric withstanding	3, 6									
Insulation Resistance	2, 5									
Temperature Rising								2		
Mating Force		3, 7								
Unmating Force		4, 6								
Durability		5								
Vibration			3							
Mechanical Shock			4							
Solderability										2
Resistance to Soldering									2	
Thermal Shock				3						
Humidity Temperature	4				3					
Temperature Life						3				
Salt Spray							3			
備注	無客戶指定增加測試項目外，依照此標準進行產品可靠性評估。									

核准：唐竹君

制作人：魏红

3	Cold test	Temperature: -25 ±3°C Duration:168H	PROGRAM CONTROLLED TEMP. & HUMIDTY CHAMBER	No physical damage	Pass	Pass	Pass	Pass	Pass	P	
4	Temperature cycling test	Temperature:85 ~-25°C Duration:5 cycle	PROGRAM CONTROLLED TEMP. & HUMIDTY CHAMBER	No physical damage	Pass	Pass	Pass	Pass	Pass	P	

四.物理測試 PHYSICAL TEST

序 號 NO.	測試項目 Testing Item	測試條件 Testing Conditions	測試設備 Testing Equipment	規格 SPEC	測試記錄 Testing Result					判定 Judge	
					1	2	3	4	5	Pass	Fail
1	Salt spray test	Temperature: 35±2°C Concentration:5±1 %Duration:12H	SALT SPRAY TESTER	No Oxidation	Pass	Pass	Pass	Pass	Pass	P	
2	Resistance to soldering heat test	Temperature: 260±5°C Duration:10±1sec	OVEN	No physical damage	Pass	Pass	Pass	Pass	Pass	P	
3	Solder ability test	Temperature: 260±5°C Duration:5±0.5 sec	CONTROLLED CONSTANT-TEMP SOLDER POT	Soldering area ≥95□	Pass	Pass	Pass	Pass	Pass	P	
判定 Result		<input checked="" type="checkbox"/> 合格 (ACCEPT) <input type="checkbox"/> 不合格 (REJECT)									

核准(Approver): 欠必峰

測試(Tester): 但芬

檢驗報告

首件檢驗
 入庫檢驗
 出貨檢驗
 客退檢驗
 退料檢驗
 其他

2022年06月23日 版次:A1

料號	JK1-208-G717	制令單號	/	送檢單位	工程部	首件製作者	裝配	
品名	耳机 音频母座	客戶代號	/	批 量	/	送檢時間	/	
				數 量	5PCS	確認時間	/	
抽樣標準		<input checked="" type="checkbox"/> 單次 <input type="checkbox"/> 雙次		抽樣數	AQL	CRI:0 MAJ:0.40	MIN:0.65	
MIL-STD-105E(II)		<input checked="" type="checkbox"/> 正常 <input type="checkbox"/> 加嚴 <input type="checkbox"/> 減量		(5PCS)	ACC/REJ	0 /	/	
不良數: CRI (/) MAJ (/) MIN (/)						不良率(%)		/

NO.	檢驗項目 單位:MM/G	檢測 儀器	檢 驗 記 錄					品管判定		CRI	MAJ	MIN	備注
			1	2	3	4	5	AC	RE				
	9.7±0.30	D	9.75	9.73	9.76	9.74	9.75	√					
	6.5±0.30	D	6.53	6.56	6.54	6.53	6.54	√					
	10±0.30	D	10.04	10.05	10.03	10.06	10.05	√					
	12±0.30	D	12.04	12.06	12.05	12.03	12.05	√					
	8.4±0.30	D	8.45	8.43	8.46	8.43	8.44	√					
	11±0.30	D	11.03	11.05	11.04	11.05	11.06	√					
	9±0.30	D	9.05	9.03	9.04	9.05	9.04	√					

 檢驗依據: 《工程圖紙》 《檢驗規範》 《承認書》 樣品 其它

檢測儀器:A游標卡尺 B千分尺 C厚薄儀 D投影鏡 E放大鏡 F顯微鏡 G錫爐 H插拔力器 I間位尺 J其它

品保判定:

核 准 APP	欠必鋒	審 核 CHK	/	檢驗員 INSPBY	但芬
------------	-----	------------	---	---------------	----

保存期限:三年

保存部門:品保部

QR-M-003

品名: 耳机音频母座(端子)		版次:A.0			
电镀规格: Ni30u", Sn100u", Au G/Fu"		日期: 2022-03-20			
页次: 1/1					
厂商: 同华					
测试设备: CMI X-射线膜厚测试仪					
1、底层电镀测试 (Ni)					
数据	测试标准	实测值	判定	测试日期	测试时间
1	30u"MIN	50.5u"	OK	2022/3/20	10:20:15
2	30u"MIN	56.3u"	OK	2022/3/20	10:20:17
3	30u"MIN	67.5u"	OK	2022/3/20	10:20:19
4	30u"MIN	62.4u"	OK	2022/3/20	10:20:21
2、表层电镀测试 (Sn)					
数据	测试标准	实测值	判定	测试日期	测试时间
1	100u"MIN	105.3u"	OK	2022/3/20	10:25:10
2	100u"MIN	104.7u"	OK	2022/3/20	10:25:12
3	100u"MIN	105.9u"	OK	2022/3/20	10:25:14
4	100u"MIN	107.4u"	OK	2022/3/20	10:25:16
3、表层电镀测试 (Au)					
数据	测试标准	实测值	判定	测试日期	测试时间
1	0.5u"MIN	0.52u"	OK	2022/3/20	10:30:32
2	0.5u"MIN	0.55u"	OK	2022/3/20	10:30:34
3	0.5u"MIN	0.53u"	OK	2022/3/20	10:30:36
4	0.5u"MIN	0.54u"	OK	2022/3/20	10:30:38

核准: 欠必锋

审核: 李娟

检验员: 但芬



深圳市华联威电子科技有限公司

盐水喷雾实验报告

试验方法	盐水喷雾腐蚀试验法	参考资料	MIL-STD-1345
METHOD	NEUTRL SALT SPRAY CORROSION TEST	REF	
客户		试验起始日期	2022年06月22日 20:00 时起
		DATE	2022年06月23日 08:00 时止
样品名称	耳机 音频母座	试验数量	5PCS
P/N	JK1-208-G717	QTY	

试验条件 (TEST CONDITION)

- 1、盐水溶解 (SALT SOLUTION: 浓度 $50 \pm 10\text{g/L}$, PH值6.5-7.2).
- 2、试验室温度 (TEMP. IT THE SPRAY DHAMBR): $35 \pm 1^\circ\text{C}$.
- 3、盐水桶温度 (TEMP. OF SALE SOL' N TANK): $35 \pm 1^\circ\text{C}$.
- 4、压力桶温度 (TEMP. OF SAR SUPPLIERY): $47 \pm 1^\circ\text{C}$.
- 5、试验室相对湿度 (R. H IN THE CHAMBER) 85%.
- 6、压缩空气压力 (COMPRESSED AIR PRESSURE): $1.00 \pm 0.01\text{Kg/cm}^2$.
- 7、样品放置位置 (SPECIMEN SUPPORTED ANGLE): 尼龙绳吊挂 $70^\circ - 90^\circ$.
- 8、喷雾收集量 (COLLECT RATE OF SALT SOL' N) $1-2\text{mL}/(8 \text{ cm}^2\text{hr})$.
- 9、盐雾测试时间: 12小时 (H)

判定方法 (ADFUSGD METHOD)

试验后以20倍放大镜观察、无蓝、绿色腐蚀物之现象 (不包含折弯处), 即判定合格. (Inspext the ecimen at 20 xmagnification no blue or green corrosion products are acceptable)

样品序号	试验后现象	判定
	PHENOMENON AFTER TEST	COMMENT
1	无蓝、绿色腐蚀物之现象	OK
2	无蓝、绿色腐蚀物之现象	OK
3	无蓝、绿色腐蚀物之现象	OK
4	无蓝、绿色腐蚀物之现象	OK
5	无蓝、绿色腐蚀物之现象	OK

核准: 欠必锋

审核: 李娟

试验员: 但芬

鉅鼎銅材廠檢驗報告單

公司名稱 Customer	鉅鼎銅材廠檢驗報告單				重量 Weight(kg)	1078	出貨日期 Date	2021/11/23		
品名 Article	標準 Standard No				尺寸 Dimension		狀態 Tenper	銅卷編號 Coil No		
C2680	JISH3100:2017				0.18*400		EH	1021-C-08		
化學成分Chemical Compositions(%)										
元素 Element	Cu %	Zn%	Pb%	Fe%	\	\	\	\	化學成分	雜質
規範 Spec	64.0-68.0	餘量	<0.05	<0.05	\	\	\	\	合格	合格
實測 Actual	64.32	餘量	0.0036	0.0136	\	\	\	\	合格	合格
機械性質Mechanical Properties										
項目 Item	結晶粒度 Grain Size Mm	硬度 Hardness Hv	抗拉強度 TensionStrength Mpa	伸長度 Elongation %	導電率 Electrical Conduc %IACS	彎曲試驗 Bending Test 180	表面粗度 Surface Roughness Ra(u m)	彎曲度 Camber mm/n		
規範MAX Spec	\	170-190	490-610	\	\	\	\	\		
實測 Actual	\	178	574	5	\	\	\	\		

品質部



Test Report

No. CANEC2119174201

Date: 22 Oct 2021

Page 1 of 4

SHENZHEN HUALIANWEI ELECTRONICS TECHNOLOGY CO.,LTD

101, 201, PLANT 1, NO.307, GUANLAN GUIHUA ROAD, GUIXIANG COMMUNITY, GUANLAN SUB-DISTRICT, LONGHUA DISTRICT, SHENZHEN CITY, GUANGDONG PROVINCE, CHINA

The following sample(s) was/were submitted and identified on behalf of the clients as : C2680 Terminal

SGS Job No. : CP21-055214 - GZ
Model No. : C2680 terminal after plating
Client Ref. Info. : Used for USB series, HDMI series, RJ series, 1394 series, MICRO series, MINI series, DISPLAYPORT series, VGA series, DVI series, TYPE-C series, JACK series
Date of Sample Received : 18 Oct 2021
Testing Period : 18 Oct 2021 - 22 Oct 2021
Test Requested : Selected test(s) as requested by client.
Test Method : Please refer to next page(s).
Test Results : Please refer to next page(s).
Conclusion : Based on the performed tests on submitted sample(s), the results of Lead, Mercury, Cadmium, Hexavalent chromium comply with the limits as set by RoHS Directive (EU) 2015/863 amending Annex II to Directive 2011/65/EU.

Signed for and on behalf of
SGS-CSTC Standards Technical Services Co., Ltd. Guangzhou Branch

Allie Chen

Allie Chen
Approved Signatory

scan to see the report



94BEAB15



SGS-CSTC Standards Technical Services Co., Ltd.
Guangzhou Branch Testing Center Chemical Laboratory.

Unless otherwise agreed in writing, this document is issued by the Company subject to its General Conditions of Service printed overleaf, available on request or accessible at <http://www.sgs.com/en/Terms-and-Conditions.aspx> and, for electronic format documents, subject to Terms and Conditions for Electronic Documents at <http://www.sgs.com/en/Terms-and-Conditions/Terms-e-Documents.aspx>. Attention is drawn to the limitation of liability, indemnification and jurisdiction issues defined therein. Any holder of this document is advised that information contained hereon reflects the Company's findings at the time of its intervention only and within the limits of Client's instructions, if any. The Company's sole responsibility is to its Client and this document does not exonerate parties to a transaction from exercising all their rights and obligations under the transaction documents. This document cannot be reproduced except in full, without prior written approval of the Company. Any unauthorized alteration, forgery or falsification of the content or appearance of this document is unlawful and offenders may be prosecuted to the fullest extent of the law. Unless otherwise stated the results shown in this test report refer only to the sample(s) tested.

Attention: To check the authenticity of testing / inspection report & certificate, please contact us at telephone: (86-755) 8307 1443, or email: CN.Doccheck@sgs.com

198 Kazhu Road, Sciotech Park Guangzhou Economic & Technology Development District, Guangzhou, China 510663

中国·广州·经济技术开发区科学城科珠路198号 邮编: 510663

t (86-20) 82155555 www.sgs.com

t (86-20) 82155555 sgs.china@sgs.com

Test Report

No. CANEC2119174201

Date: 22 Oct 2021

Page 2 of 4

Test Results :

Test Part Description :

Specimen No.	SGS Sample ID	Description
SN1	CAN21-191742.001	Silver-grey/brassy metal

Remarks :

- (1) 1 mg/kg = 0.0001%
- (2) MDL = Method Detection Limit
- (3) ND = Not Detected (< MDL)
- (4) "-" = Not Regulated

RoHS Directive (EU) 2015/863 amending Annex II to Directive 2011/65/EU

Test Method : With reference to IEC 62321-4:2013+A1:2017, IEC 62321-5:2013, IEC 62321-7-1:2015, analyzed by ICP-OES and UV-Vis .

Test Item(s)	Limit	Unit	MDL	001
Cadmium (Cd)	100	mg/kg	2	ND
Lead (Pb)	1,000	mg/kg	2	44
Mercury (Hg)	1,000	mg/kg	2	ND
Hexavalent Chromium (Cr(VI))▼	-	µg/cm ²	0.10	ND

Notes :

- (1) The maximum permissible limit is quoted from RoHS Directive (EU) 2015/863.
- (2) IEC 62321 series is equivalent to EN 62321 series
https://www.cenelec.eu/dyn/www/f?p=104:30:1742232870351101:::FSP_ORG_ID,FSP_LANG_ID:1258637,25
- (3) ▼= a. The sample is positive for CrVI if the CrVI concentration is greater than 0.13 µg/cm². The sample coating is considered to contain CrVI
 b. The sample is negative for CrVI if CrVI is ND (concentration less than 0.10 µg/cm²). The coating is considered a non-CrVI based coating
 c. The result between 0.10 µg/cm² and 0.13 µg/cm² is considered to be inconclusive - unavoidable coating variations may influence the determination
 Information on storage conditions and production date of the tested sample is unavailable and thus Cr(VI) results represent status of the sample at the time of testing.



Unless otherwise agreed in writing, this document is issued by the Company subject to its General Conditions of Service printed overleaf, available on request or accessible at <http://www.sgs.com/en/Terms-and-Conditions.aspx> and, for electronic format documents, subject to Terms and Conditions for Electronic Documents at <http://www.sgs.com/en/Terms-and-Conditions/Terms-e-Document.aspx>. Attention is drawn to the limitation of liability, indemnification and jurisdiction issues defined therein. Any holder of this document is advised that information contained hereon reflects the Company's findings at the time of its intervention only and within the limits of Client's instructions, if any. The Company's sole responsibility is to its Client and this document does not exonerate parties to a transaction from exercising all their rights and obligations under the transaction documents. This document cannot be reproduced except in full, without prior written approval of the Company. Any unauthorized alteration, forgery or falsification of the content or appearance of this document is unlawful and offenders may be prosecuted to the fullest extent of the law. Unless otherwise stated the results shown in this test report refer only to the sample(s) tested.

Attention: To check the authenticity of testing / inspection report & certificate, please contact us at telephone: (86-755) 8307 1443, or email: CN.Doccheck@sgs.com

ATTACHMENTS

Pb/Cd/Hg/Cr⁶⁺ Testing Flow Chart

1) These samples were dissolved totally by pre-conditioning method according to below flow chart. (Cr⁶⁺ test method excluded).

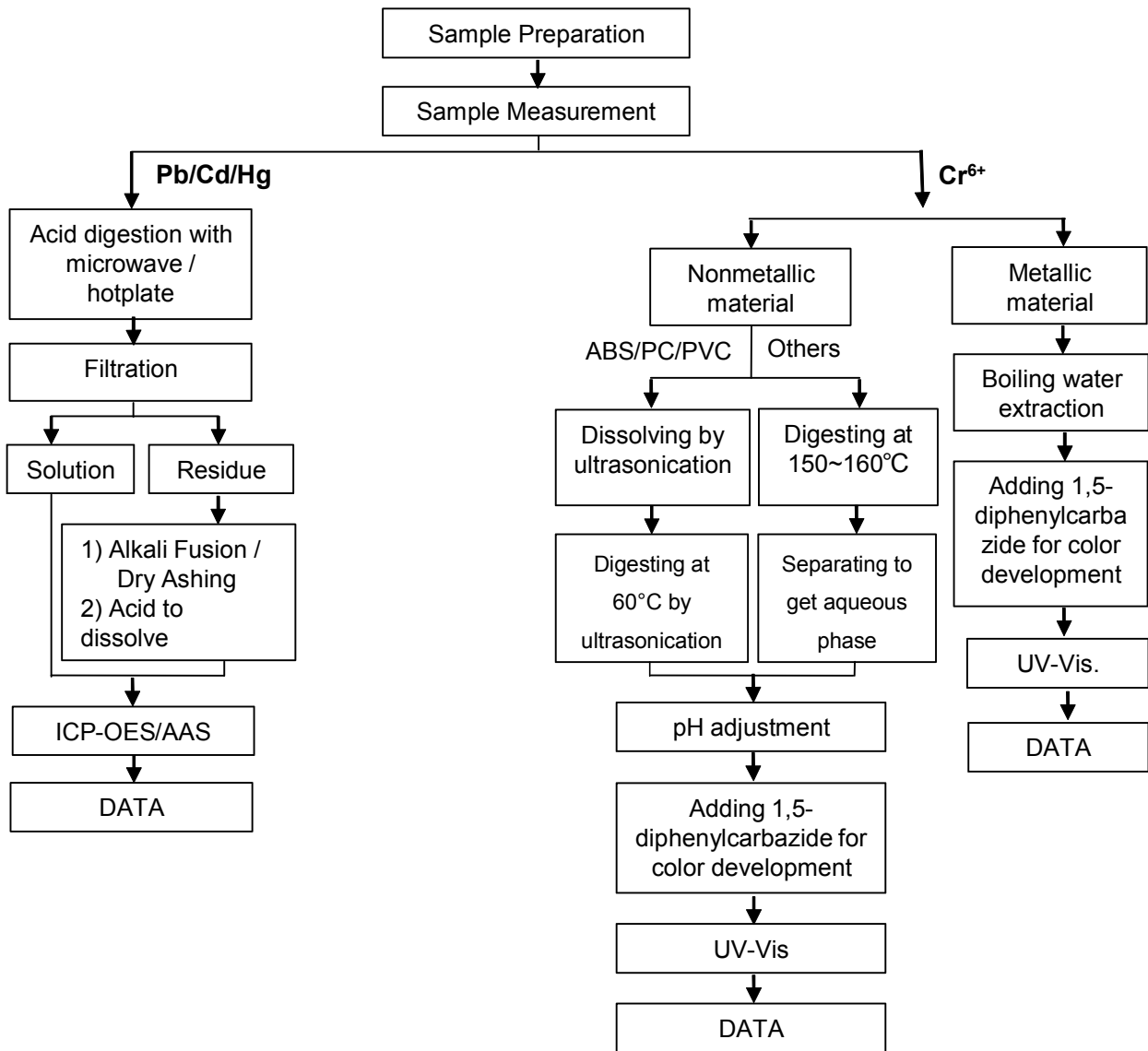

Sample photo:



SGS authenticate the photo on original report only

*** End of Report ***



Test Report

No. CANEC2117633803

Date: 27 Sep 2021

Page 1 of 8

SHENZHEN CITY TONGHUA INDUSTRY CO.,LTD

TONGHUA MANSIN TONGLE XINBU VILLANG TOWN SHENZHEN CITY CHINA

The following sample(s) was/were submitted and identified on behalf of the clients as : Nickel(Ni)

SGS Job No. : CP21-051017 - SZ

Date of Sample Received : 18 Sep 2021

Testing Period : 18 Sep 2021 - 27 Sep 2021

Test Requested : Selected test(s) as requested by client.

Test Method : Please refer to next page(s).

Test Results : Please refer to next page(s).

Conclusion : Based on the performed tests on submitted sample(s), the results of Lead, Mercury, Cadmium, Hexavalent chromium, Polybrominated biphenyls (PBBs), Polybrominated diphenyl ethers (PBDEs) and Phthalates such as Bis(2-ethylhexyl) phthalate (DEHP) , Butyl benzyl phthalate (BBP), Dibutyl phthalate (DBP) , and Diisobutyl phthalate (DIBP) comply with the limits as set by RoHS Directive (EU) 2015/863 amending Annex II to Directive 2011/65/EU.

Signed for and on behalf of
SGS-CSTC Standards Technical Services Co., Ltd. Guangzhou Branch

Allie Chen

Allie Chen
Approved Signatory

scan to see the report



CANEC2117633803



SGS-CSTC Standards Technical Services Co., Ltd.
Guangzhou Branch Testing Center Chemical Laboratory.

Unless otherwise agreed in writing, this document is issued by the Company subject to its General Conditions of Service printed overleaf, available on request or accessible at <http://www.sgs.com/en/Terms-and-Conditions.aspx> and, for electronic format documents, subject to Terms and Conditions for Electronic Documents at <http://www.sgs.com/en/Terms-and-Conditions/Terms-e-Document.aspx>. Attention is drawn to the limitation of liability, indemnification and jurisdiction issues defined therein. Any holder of this document is advised that information contained hereon reflects the Company's findings at the time of its intervention only and within the limits of Client's instructions, if any. The Company's sole responsibility is to its Client and this document does not exonerate parties to a transaction from exercising all their rights and obligations under the transaction documents. This document cannot be reproduced except in full, without prior written approval of the Company. Any unauthorized alteration, forgery or falsification of the content or appearance of this document is unlawful and offenders may be prosecuted to the fullest extent of the law. Unless otherwise stated the results shown in this test report refer only to the sample(s) tested.

Attention: To check the authenticity of testing /inspection report & certificate, please contact us at telephone: (86-755) 8307 1443, or email: CN.Doccheck@sgs.com

198 Kazhu Road, Sciotech Park Guangzhou Economic & Technology Development District, Guangzhou, China 510663

中国·广州·经济技术开发区科学城科珠路198号

邮编: 510663

t (86-20) 82155555 www.sgs.com

t (86-20) 82155555 sgs.china@sgs.com

Test Report

No. CANEC2117633803

Date: 27 Sep 2021

Page 2 of 8

Test Results :

Test Part Description :

Specimen No.	SGS Sample ID	Description
SN1	CAN21-176338.003	Silver-gray plated metal

Remarks :

- (1) 1 mg/kg = 1 ppm = 0.0001%
- (2) MDL = Method Detection Limit
- (3) ND = Not Detected (< MDL)
- (4) "-" = Not Regulated

RoHS Directive (EU) 2015/863 amending Annex II to Directive 2011/65/EU

Test Method : With reference to IEC 62321-4:2013+A1:2017, IEC 62321-5:2013, IEC 62321-7-1:2015 , IEC 62321-6:2015 and IEC 62321-8:2017, analyzed by ICP-OES , UV-Vis and GC-MS .

Test Item(s)	Limit	Unit	MDL	003
Cadmium (Cd)	100	mg/kg	2	ND
Lead (Pb)	1,000	mg/kg	2	37
Mercury (Hg)	1,000	mg/kg	2	ND
Hexavalent Chromium (Cr(VI))▼	-	µg/cm ²	0.10	ND
Sum of PBBs	1,000	mg/kg	-	ND
Monobromobiphenyl	-	mg/kg	5	ND
Dibromobiphenyl	-	mg/kg	5	ND
Tribromobiphenyl	-	mg/kg	5	ND
Tetrabromobiphenyl	-	mg/kg	5	ND
Pentabromobiphenyl	-	mg/kg	5	ND
Hexabromobiphenyl	-	mg/kg	5	ND
Heptabromobiphenyl	-	mg/kg	5	ND
Octabromobiphenyl	-	mg/kg	5	ND
Nonabromobiphenyl	-	mg/kg	5	ND
Decabromobiphenyl	-	mg/kg	5	ND
Sum of PBDEs	1,000	mg/kg	-	ND
Monobromodiphenyl ether	-	mg/kg	5	ND
Dibromodiphenyl ether	-	mg/kg	5	ND
Tribromodiphenyl ether	-	mg/kg	5	ND
Tetrabromodiphenyl ether	-	mg/kg	5	ND
Pentabromodiphenyl ether	-	mg/kg	5	ND



Unless otherwise agreed in writing, this document is issued by the Company subject to its General Conditions of Service printed overleaf, available on request or accessible at <http://www.sgs.com/en/Terms-and-Conditions.aspx> and, for electronic format documents, subject to Terms and Conditions for Electronic Documents at <http://www.sgs.com/en/Terms-and-Conditions/Terms-e-Documents.aspx>. Attention is drawn to the limitation of liability, indemnification and jurisdiction issues defined therein. Any holder of this document is advised that information contained hereon reflects the Company's findings at the time of its intervention only and within the limits of Client's instructions, if any. The Company's sole responsibility is to its Client and this document does not exonerate parties to a transaction from exercising all their rights and obligations under the transaction documents. This document cannot be reproduced except in full, without prior written approval of the Company. Any unauthorized alteration, forgery or falsification of the content or appearance of this document is unlawful and offenders may be prosecuted to the fullest extent of the law. Unless otherwise stated the results shown in this test report refer only to the sample(s) tested.

Attention: To check the authenticity of testing / inspection report & certificate, please contact us at telephone: (86-755) 8307 1443, or email: CN.Doccheck@sgs.com

Test Report

No. CANEC2117633803

Date: 27 Sep 2021

Page 3 of 8

<u>Test Item(s)</u>	<u>Limit</u>	<u>Unit</u>	<u>MDL</u>	<u>003</u>
Hexabromodiphenyl ether	-	mg/kg	5	ND
Heptabromodiphenyl ether	-	mg/kg	5	ND
Octabromodiphenyl ether	-	mg/kg	5	ND
Nonabromodiphenyl ether	-	mg/kg	5	ND
Decabromodiphenyl ether	-	mg/kg	5	ND
Dibutyl phthalate (DBP)	1000	mg/kg	50	ND
Butyl benzyl phthalate (BBP)	1000	mg/kg	50	ND
Bis (2-ethylhexyl) phthalate (DEHP)	1000	mg/kg	50	ND
Diisobutyl Phthalates (DIBP)	1000	mg/kg	50	ND

Notes :

- (1) The maximum permissible limit is quoted from RoHS Directive (EU) 2015/863.
- (2) IEC 62321 series is equivalent to EN 62321 series
https://www.cenelec.eu/dyn/www/f?p=104:30:1742232870351101:::FSP_ORG_ID,FSP_LANG_ID:1258637,25
- (3) ▼ = a. The sample is positive for CrVI if the CrVI concentration is greater than 0.13 µg/cm². The sample coating is considered to contain CrVI
 b. The sample is negative for CrVI if CrVI is ND (concentration less than 0.10 µg/cm²). The coating is considered a non-CrVI based coating
 c. The result between 0.10 µg/cm² and 0.13 µg/cm² is considered to be inconclusive - unavoidable coating variations may influence the determination
 Information on storage conditions and production date of the tested sample is unavailable and thus Cr(VI) results represent status of the sample at the time of testing.

Perfluorooctanoic acid (PFOA) and its salts & Perfluorooctane sulfonates (PFOS) and its derivatives

Test Method : With reference to CEN/TS15968:2010, analysis was performed by LC-MS or LC-MS/MS.

<u>Test Item(s)</u>	<u>CAS NO.</u>	<u>Unit</u>	<u>MDL</u>	<u>003</u>
Perfluorooctanoic acid (PFOA) and its salts+	335-67-1	mg/kg	0.010	ND
Perfluorooctane sulfonates (PFOS) ^	1763-23-1	mg/kg	0.010	ND
Perfluorooctane Sulfonamide (PFOSA)	754-91-6	mg/kg	0.010	ND
N-methylperfluoro-1-octanesulfonamide(MeFOSA)	31506-32-8	mg/kg	0.010	ND
N-ethylperfluoro-1-octanesulfonamide (EtFOSA)	4151-50-2	mg/kg	0.010	ND
2-(N-methylperfluoro-1-octanesulfonamido)-ethanol(MeFOSE)	24448-09-7	mg/kg	0.010	ND
2-(N-ethylperfluoro-1-octanesulfonamido)-ethanol(EtFOSE)	1691-99-2	mg/kg	0.010	ND
Perfluorooctane sulfonates (PFOS) and its derivatives	-	mg/kg	-	ND



Unless otherwise agreed in writing, this document is issued by the Company subject to its General Conditions of Service printed overleaf, available on request or accessible at <http://www.sgs.com/en/Terms-and-Conditions.aspx> and, for electronic format documents, subject to Terms and Conditions for Electronic Documents at <http://www.sgs.com/en/Terms-and-Conditions/Terms-e-Documents.aspx>. Attention is drawn to the limitation of liability, indemnification and jurisdiction issues defined therein. Any holder of this document is advised that information contained hereon reflects the Company's findings at the time of its intervention only and within the limits of Client's instructions, if any. The Company's sole responsibility is to its Client and this document does not exonerate parties to a transaction from exercising all their rights and obligations under the transaction documents. This document cannot be reproduced except in full, without prior written approval of the Company. Any unauthorized alteration, forgery or falsification of the content or appearance of this document is unlawful and offenders may be prosecuted to the fullest extent of the law. Unless otherwise stated the results shown in this test report refer only to the sample(s) tested.

Attention: To check the authenticity of testing / inspection report & certificate, please contact us at telephone: (86-755) 8307 1443, or email: CN.Doccheck@sgs.com

Notes :

- (1) + PFOA and its salts including PFOA-Na (CAS No.: 335-95-5), PFOA-K (CAS No.: 2395-00-8), PFOA-Ag (CAS No.: 335-93-3), PFOA-F (CAS No.: 335-66-0) and APFO (CAS No.: 3825-26-1);
- (2) ^ PFOS including PFOS-K (CAS No.: 2795-39-3), PFOS-Li (CAS No.: 29457-72-5), PFOS-NH₄ (CAS No.: 29081-56-9), PFOS-NH(OH)₂ (CAS No.: 70225-14-8), PFOS-N(C₂H₅)₄ (CAS No.: 56773-42-3), PFOS-DDA(CAS No.:251099-16-8) and POSF (CAS No.: 307-35-7)



Unless otherwise agreed in writing, this document is issued by the Company subject to its General Conditions of Service printed overleaf, available on request or accessible at <http://www.sgs.com/en/Terms-and-Conditions.aspx> and, for electronic format documents, subject to Terms and Conditions for Electronic Documents at <http://www.sgs.com/en/Terms-and-Conditions/Terms-e-Documents.aspx>. Attention is drawn to the limitation of liability, indemnification and jurisdiction issues defined therein. Any holder of this document is advised that information contained hereon reflects the Company's findings at the time of its intervention only and within the limits of Client's instructions, if any. The Company's sole responsibility is to its Client and this document does not exonerate parties to a transaction from exercising all their rights and obligations under the transaction documents. This document cannot be reproduced except in full, without prior written approval of the Company. Any unauthorized alteration, forgery or falsification of the content or appearance of this document is unlawful and offenders may be prosecuted to the fullest extent of the law. Unless otherwise stated the results shown in this test report refer only to the sample(s) tested.

Attention: To check the authenticity of testing /inspection report & certificate, please contact us at telephone: (86-755) 8307 1443, or email: CN.Doccheck@sgs.com

ATTACHMENTS

Pb/Cd/Hg/Cr⁶⁺/PBBs/PBDEs Testing Flow Chart

1) These samples were dissolved totally by pre-conditioning method according to below flow chart. (Cr⁶⁺ and PBBs/PBDEs test method excluded).

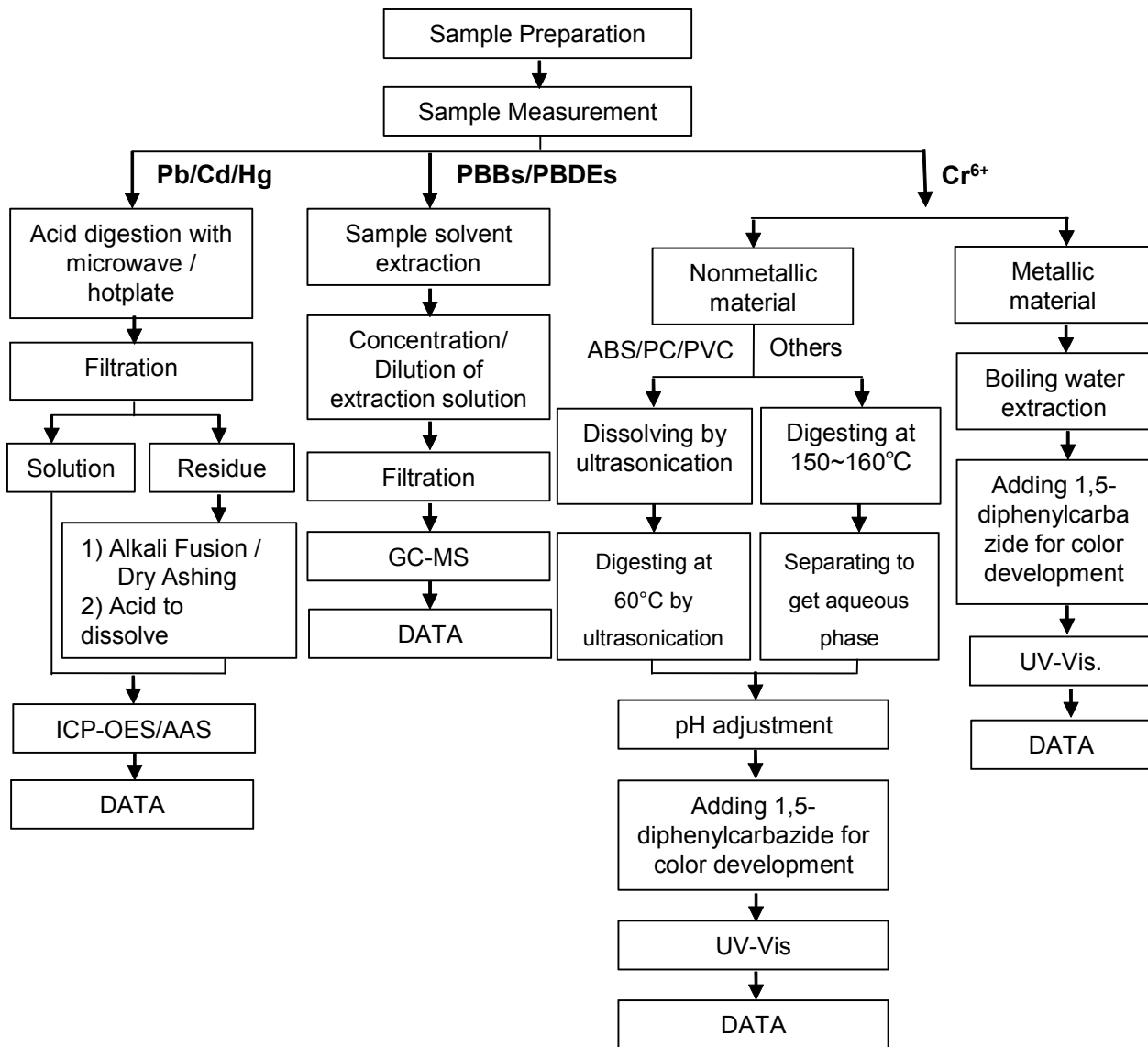

ATTACHMENTS

Phthalates Testing Flow Chart

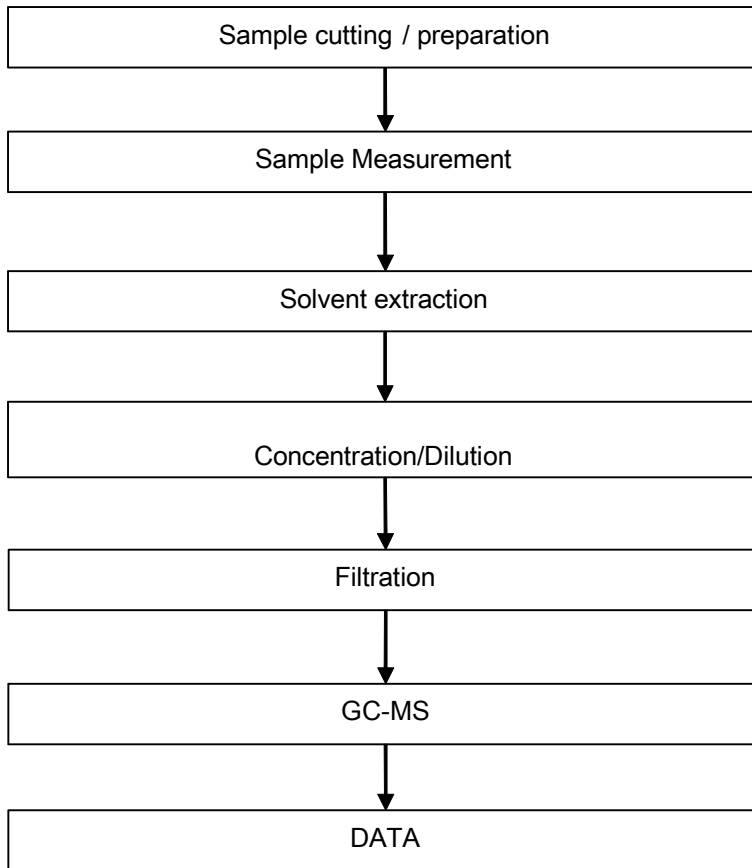

Unless otherwise agreed in writing, this document is issued by the Company subject to its General Conditions of Service printed overleaf, available on request or accessible at <http://www.sgs.com/en/Terms-and-Conditions.aspx> and, for electronic format documents, subject to Terms and Conditions for Electronic Documents at <http://www.sgs.com/en/Terms-and-Conditions/Terms-e-Document.aspx>. Attention is drawn to the limitation of liability, indemnification and jurisdiction issues defined therein. Any holder of this document is advised that information contained hereon reflects the Company's findings at the time of its intervention only and within the limits of Client's instructions, if any. The Company's sole responsibility is to its Client and this document does not exonerate parties to a transaction from exercising all their rights and obligations under the transaction documents. This document cannot be reproduced except in full, without prior written approval of the Company. Any unauthorized alteration, forgery or falsification of the content or appearance of this document is unlawful and offenders may be prosecuted to the fullest extent of the law. Unless otherwise stated the results shown in this test report refer only to the sample(s) tested.

Attention: To check the authenticity of testing / inspection report & certificate, please contact us at telephone: (86-755) 8307 1443, or email: CN.Doccheck@sgs.com

ATTACHMENTS

PFOA / PFOS Testing Flow Chart

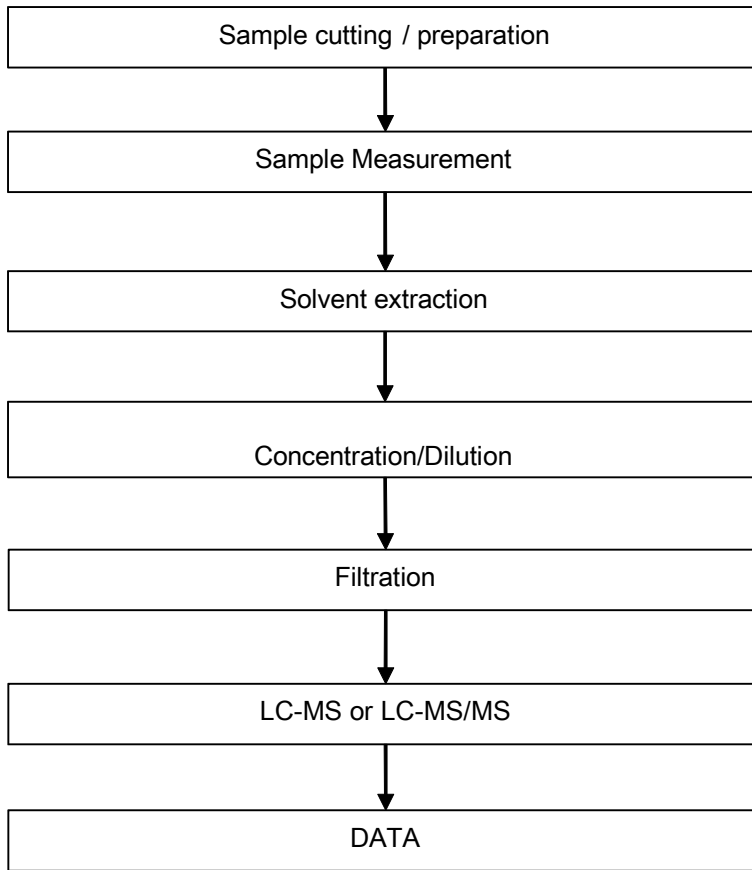

Unless otherwise agreed in writing, this document is issued by the Company subject to its General Conditions of Service printed overleaf, available on request or accessible at <http://www.sgs.com/en/Terms-and-Conditions.aspx> and, for electronic format documents, subject to Terms and Conditions for Electronic Documents at <http://www.sgs.com/en/Terms-and-Conditions/Terms-e-Document.aspx>. Attention is drawn to the limitation of liability, indemnification and jurisdiction issues defined therein. Any holder of this document is advised that information contained hereon reflects the Company's findings at the time of its intervention only and within the limits of Client's instructions, if any. The Company's sole responsibility is to its Client and this document does not exonerate parties to a transaction from exercising all their rights and obligations under the transaction documents. This document cannot be reproduced except in full, without prior written approval of the Company. Any unauthorized alteration, forgery or falsification of the content or appearance of this document is unlawful and offenders may be prosecuted to the fullest extent of the law. Unless otherwise stated the results shown in this test report refer only to the sample(s) tested.

Attention: To check the authenticity of testing / inspection report & certificate, please contact us at telephone: (86-755) 8307 1443, or email: CN.Doccheck@sgs.com

Sample photo:



SGS authenticate the photo on original report only

*** End of Report ***



Test Report

No. CANEC2117633802

Date: 27 Sep 2021

Page 1 of 8

SHENZHEN CITY TONGHUA INDUSTRY CO.,LTD

TONGHUA MANSIN TONGLE XINBU VILLANG TOWN SHENZHEN CITY CHINA

The following sample(s) was/were submitted and identified on behalf of the clients as : Bright Tin(SN)

SGS Job No. : CP21-051017 - SZ

Date of Sample Received : 18 Sep 2021

Testing Period : 18 Sep 2021 - 27 Sep 2021

Test Requested : Selected test(s) as requested by client.

Test Method : Please refer to next page(s).

Test Results : Please refer to next page(s).

Conclusion : Based on the performed tests on submitted sample(s), the results of Lead, Mercury, Cadmium, Hexavalent chromium, Polybrominated biphenyls (PBBs), Polybrominated diphenyl ethers (PBDEs) and Phthalates such as Bis(2-ethylhexyl) phthalate (DEHP) , Butyl benzyl phthalate (BBP), Dibutyl phthalate (DBP) , and Diisobutyl phthalate (DIBP) comply with the limits as set by RoHS Directive (EU) 2015/863 amending Annex II to Directive 2011/65/EU.

Signed for and on behalf of
SGS-CSTC Standards Technical Services Co., Ltd. Guangzhou Branch

Allie Chen

Allie Chen
Approved Signatory

scan to see the report



CANEC2117633802



SGS-CSTC Standards Technical Services Co., Ltd.
Guangzhou Branch Testing Center Chemical Laboratory.

Unless otherwise agreed in writing, this document is issued by the Company subject to its General Conditions of Service printed overleaf, available on request or accessible at <http://www.sgs.com/en/Terms-and-Conditions.aspx> and, for electronic format documents, subject to Terms and Conditions for Electronic Documents at <http://www.sgs.com/en/Terms-and-Conditions/Terms-e-Document.aspx>. Attention is drawn to the limitation of liability, indemnification and jurisdiction issues defined therein. Any holder of this document is advised that information contained hereon reflects the Company's findings at the time of its intervention only and within the limits of Client's instructions, if any. The Company's sole responsibility is to its Client and this document does not exonerate parties to a transaction from exercising all their rights and obligations under the transaction documents. This document cannot be reproduced except in full, without prior written approval of the Company. Any unauthorized alteration, forgery or falsification of the content or appearance of this document is unlawful and offenders may be prosecuted to the fullest extent of the law. Unless otherwise stated the results shown in this test report refer only to the sample(s) tested.

Attention: To check the authenticity of testing / inspection report & certificate, please contact us at telephone: (86-755) 8307 1443, or email: CN.Doccheck@sgs.com

198 Kazhu Road, Sciotech Park Guangzhou Economic & Technology Development District, Guangzhou, China 510663

中国·广州·经济技术开发区科学城科珠路198号

邮编: 510663

t (86-20) 82155555 www.sgs.com

t (86-20) 82155555 sgs.china@sgs.com

Test Report

No. CANEC2117633802

Date: 27 Sep 2021

Page 2 of 8

Test Results :

Test Part Description :

Specimen No.	SGS Sample ID	Description
SN1	CAN21-176338.002	Silver-gray plated metal

Remarks :

- (1) 1 mg/kg = 1 ppm = 0.0001%
- (2) MDL = Method Detection Limit
- (3) ND = Not Detected (< MDL)
- (4) "-" = Not Regulated

RoHS Directive (EU) 2015/863 amending Annex II to Directive 2011/65/EU

Test Method : With reference to IEC 62321-4:2013+A1:2017, IEC 62321-5:2013, IEC 62321-7-1:2015 , IEC 62321-6:2015 and IEC 62321-8:2017, analyzed by ICP-OES , UV-Vis and GC-MS .

Test Item(s)	Limit	Unit	MDL	002
Cadmium (Cd)	100	mg/kg	2	ND
Lead (Pb)	1,000	mg/kg	2	29
Mercury (Hg)	1,000	mg/kg	2	ND
Hexavalent Chromium (Cr(VI))▼	-	µg/cm ²	0.10	ND
Sum of PBBs	1,000	mg/kg	-	ND
Monobromobiphenyl	-	mg/kg	5	ND
Dibromobiphenyl	-	mg/kg	5	ND
Tribromobiphenyl	-	mg/kg	5	ND
Tetrabromobiphenyl	-	mg/kg	5	ND
Pentabromobiphenyl	-	mg/kg	5	ND
Hexabromobiphenyl	-	mg/kg	5	ND
Heptabromobiphenyl	-	mg/kg	5	ND
Octabromobiphenyl	-	mg/kg	5	ND
Nonabromobiphenyl	-	mg/kg	5	ND
Decabromobiphenyl	-	mg/kg	5	ND
Sum of PBDEs	1,000	mg/kg	-	ND
Monobromodiphenyl ether	-	mg/kg	5	ND
Dibromodiphenyl ether	-	mg/kg	5	ND
Tribromodiphenyl ether	-	mg/kg	5	ND
Tetrabromodiphenyl ether	-	mg/kg	5	ND
Pentabromodiphenyl ether	-	mg/kg	5	ND



Unless otherwise agreed in writing, this document is issued by the Company subject to its General Conditions of Service printed overleaf, available on request or accessible at <http://www.sgs.com/en/Terms-and-Conditions.aspx> and, for electronic format documents, subject to Terms and Conditions for Electronic Documents at <http://www.sgs.com/en/Terms-and-Conditions/Terms-e-Documents.aspx>. Attention is drawn to the limitation of liability, indemnification and jurisdiction issues defined therein. Any holder of this document is advised that information contained hereon reflects the Company's findings at the time of its intervention only and within the limits of Client's instructions, if any. The Company's sole responsibility is to its Client and this document does not exonerate parties to a transaction from exercising all their rights and obligations under the transaction documents. This document cannot be reproduced except in full, without prior written approval of the Company. Any unauthorized alteration, forgery or falsification of the content or appearance of this document is unlawful and offenders may be prosecuted to the fullest extent of the law. Unless otherwise stated the results shown in this test report refer only to the sample(s) tested.

Attention: To check the authenticity of testing / inspection report & certificate, please contact us at telephone: (86-755) 8307 1443, or email: CN.Doccheck@sgs.com

Test Report

No. CANEC2117633802

Date: 27 Sep 2021

Page 3 of 8

<u>Test Item(s)</u>	<u>Limit</u>	<u>Unit</u>	<u>MDL</u>	<u>002</u>
Hexabromodiphenyl ether	-	mg/kg	5	ND
Heptabromodiphenyl ether	-	mg/kg	5	ND
Octabromodiphenyl ether	-	mg/kg	5	ND
Nonabromodiphenyl ether	-	mg/kg	5	ND
Decabromodiphenyl ether	-	mg/kg	5	ND
Dibutyl phthalate (DBP)	1000	mg/kg	50	ND
Butyl benzyl phthalate (BBP)	1000	mg/kg	50	ND
Bis (2-ethylhexyl) phthalate (DEHP)	1000	mg/kg	50	ND
Diisobutyl Phthalates (DIBP)	1000	mg/kg	50	ND

Notes :

- (1) The maximum permissible limit is quoted from RoHS Directive (EU) 2015/863.
- (2) IEC 62321 series is equivalent to EN 62321 series
https://www.cenelec.eu/dyn/www/f?p=104:30:1742232870351101:::FSP_ORG_ID,FSP_LANG_ID:1258637,25
- (3) ▼ = a. The sample is positive for CrVI if the CrVI concentration is greater than 0.13 µg/cm². The sample coating is considered to contain CrVI
 b. The sample is negative for CrVI if CrVI is ND (concentration less than 0.10 µg/cm²). The coating is considered a non-CrVI based coating
 c. The result between 0.10 µg/cm² and 0.13 µg/cm² is considered to be inconclusive - unavoidable coating variations may influence the determination
 Information on storage conditions and production date of the tested sample is unavailable and thus Cr(VI) results represent status of the sample at the time of testing.

Perfluorooctanoic acid (PFOA) and its salts & Perfluorooctane sulfonates (PFOS) and its derivatives

Test Method : With reference to CEN/TS15968:2010, analysis was performed by LC-MS or LC-MS/MS.

<u>Test Item(s)</u>	<u>CAS NO.</u>	<u>Unit</u>	<u>MDL</u>	<u>002</u>
Perfluorooctanoic acid (PFOA) and its salts+	335-67-1	mg/kg	0.010	ND
Perfluorooctane sulfonates (PFOS) ^	1763-23-1	mg/kg	0.010	ND
Perfluorooctane Sulfonamide (PFOSA)	754-91-6	mg/kg	0.010	ND
N-methylperfluoro-1-octanesulfonamide(MeFOSA)	31506-32-8	mg/kg	0.010	ND
N-ethylperfluoro-1-octanesulfonamide (EtFOSA)	4151-50-2	mg/kg	0.010	ND
2-(N-methylperfluoro-1-octanesulfonamido)-ethanol(MeFOSE)	24448-09-7	mg/kg	0.010	ND
2-(N-ethylperfluoro-1-octanesulfonamido)-ethanol(EtFOSE)	1691-99-2	mg/kg	0.010	ND
Perfluorooctane sulfonates (PFOS) and its derivatives	-	mg/kg	-	ND



Unless otherwise agreed in writing, this document is issued by the Company subject to its General Conditions of Service printed overleaf, available on request or accessible at <http://www.sgs.com/en/Terms-and-Conditions.aspx> and, for electronic format documents, subject to Terms and Conditions for Electronic Documents at <http://www.sgs.com/en/Terms-and-Conditions/Terms-e-Documents.aspx>. Attention is drawn to the limitation of liability, indemnification and jurisdiction issues defined therein. Any holder of this document is advised that information contained hereon reflects the Company's findings at the time of its intervention only and within the limits of Client's instructions, if any. The Company's sole responsibility is to its Client and this document does not exonerate parties to a transaction from exercising all their rights and obligations under the transaction documents. This document cannot be reproduced except in full, without prior written approval of the Company. Any unauthorized alteration, forgery or falsification of the content or appearance of this document is unlawful and offenders may be prosecuted to the fullest extent of the law. Unless otherwise stated the results shown in this test report refer only to the sample(s) tested.

Attention: To check the authenticity of testing / inspection report & certificate, please contact us at telephone: (86-755) 8307 1443, or email: CN.Doccheck@sgs.com

Notes :

- (1) + PFOA and its salts including PFOA-Na (CAS No.: 335-95-5), PFOA-K (CAS No.: 2395-00-8), PFOA-Ag (CAS No.: 335-93-3), PFOA-F (CAS No.: 335-66-0) and APFO (CAS No.: 3825-26-1);
(2) ^ PFOS including PFOS-K (CAS No.: 2795-39-3), PFOS-Li (CAS No.: 29457-72-5), PFOS-NH₄ (CAS No.: 29081-56-9), PFOS-NH(OH)₂ (CAS No.: 70225-14-8), PFOS-N(C₂H₅)₄ (CAS No.: 56773-42-3), PFOS-DDA(CAS No.:251099-16-8) and POSF (CAS No.: 307-35-7)



Unless otherwise agreed in writing, this document is issued by the Company subject to its General Conditions of Service printed overleaf, available on request or accessible at <http://www.sgs.com/en/Terms-and-Conditions.aspx> and, for electronic format documents, subject to Terms and Conditions for Electronic Documents at <http://www.sgs.com/en/Terms-and-Conditions/Terms-e-Documents.aspx>. Attention is drawn to the limitation of liability, indemnification and jurisdiction issues defined therein. Any holder of this document is advised that information contained hereon reflects the Company's findings at the time of its intervention only and within the limits of Client's instructions, if any. The Company's sole responsibility is to its Client and this document does not exonerate parties to a transaction from exercising all their rights and obligations under the transaction documents. This document cannot be reproduced except in full, without prior written approval of the Company. Any unauthorized alteration, forgery or falsification of the content or appearance of this document is unlawful and offenders may be prosecuted to the fullest extent of the law. Unless otherwise stated the results shown in this test report refer only to the sample(s) tested.

Attention: To check the authenticity of testing / inspection report & certificate, please contact us at telephone: (86-755) 8307 1443, or email: CN.Doccheck@sgs.com

ATTACHMENTS

Pb/Cd/Hg/Cr⁶⁺/PBBs/PBDEs Testing Flow Chart

1) These samples were dissolved totally by pre-conditioning method according to below flow chart. (Cr⁶⁺ and PBBs/PBDEs test method excluded).

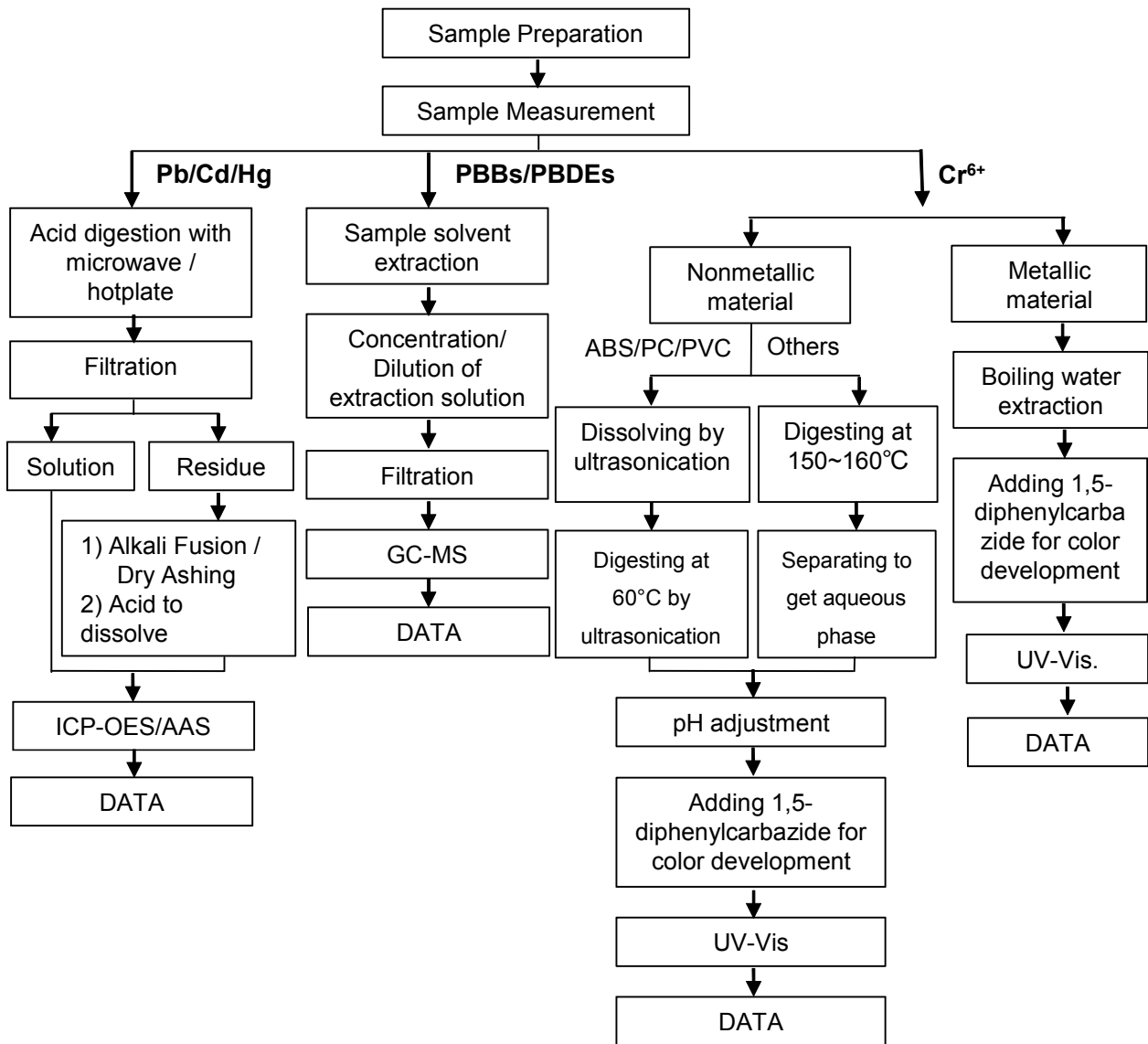

ATTACHMENTS

Phthalates Testing Flow Chart

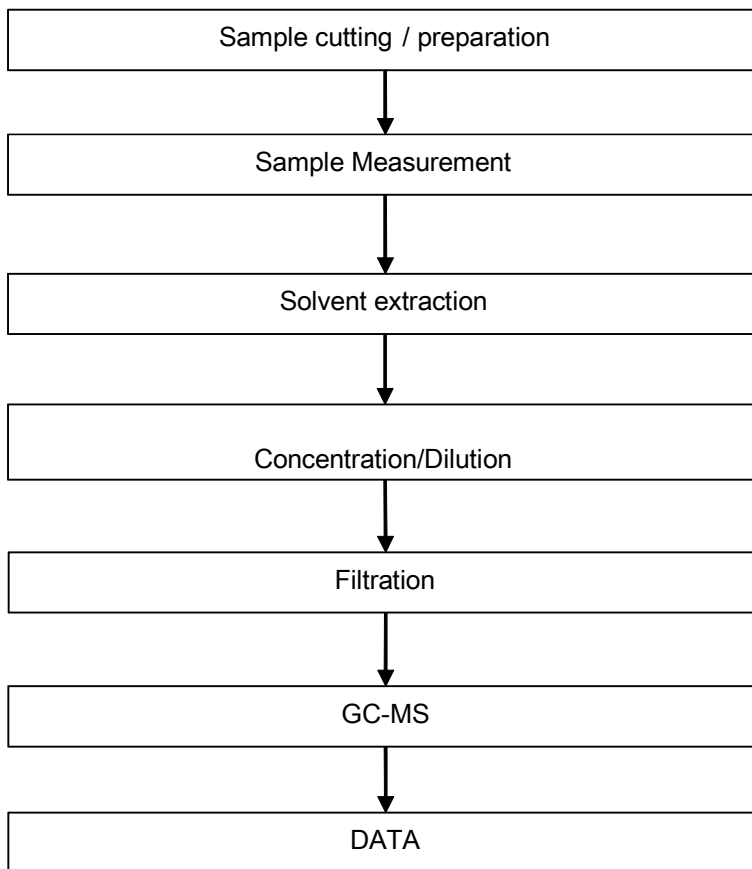

ATTACHMENTS

PFOA / PFOS Testing Flow Chart

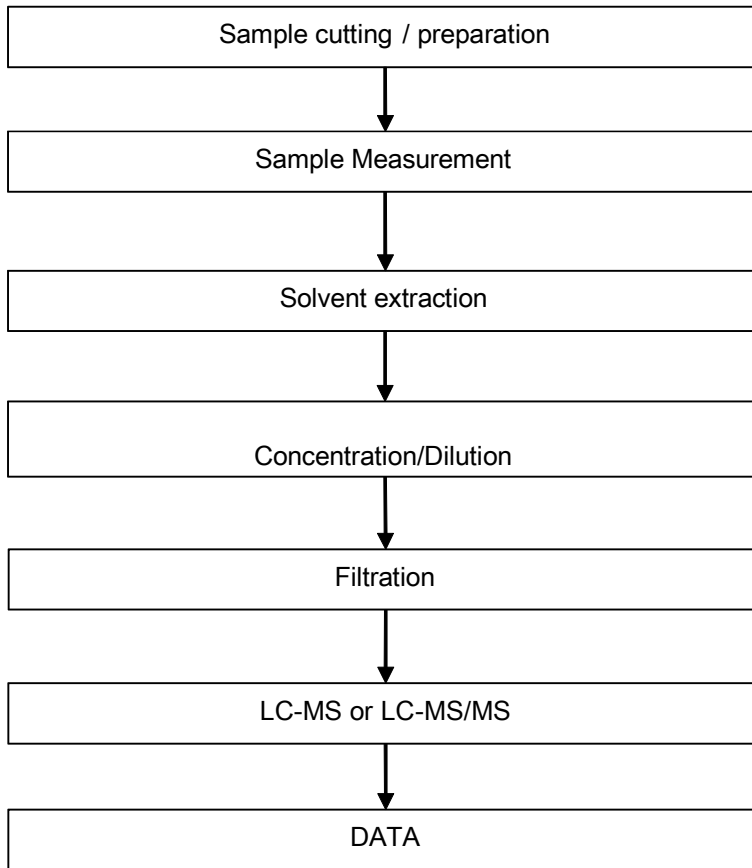

Unless otherwise agreed in writing, this document is issued by the Company subject to its General Conditions of Service printed overleaf, available on request or accessible at <http://www.sgs.com/en/Terms-and-Conditions.aspx> and, for electronic format documents, subject to Terms and Conditions for Electronic Documents at <http://www.sgs.com/en/Terms-and-Conditions/Terms-e-Document.aspx>. Attention is drawn to the limitation of liability, indemnification and jurisdiction issues defined therein. Any holder of this document is advised that information contained hereon reflects the Company's findings at the time of its intervention only and within the limits of Client's instructions, if any. The Company's sole responsibility is to its Client and this document does not exonerate parties to a transaction from exercising all their rights and obligations under the transaction documents. This document cannot be reproduced except in full, without prior written approval of the Company. Any unauthorized alteration, forgery or falsification of the content or appearance of this document is unlawful and offenders may be prosecuted to the fullest extent of the law. Unless otherwise stated the results shown in this test report refer only to the sample(s) tested.

Attention: To check the authenticity of testing / inspection report & certificate, please contact us at telephone: (86-755) 8307 1443, or email: CN.Doccheck@sgs.com

Sample photo:



SGS authenticate the photo on original report only

*** End of Report ***

