

承 认 书

Approval Sheet

客户 (Customer): /

客户料号 (Cus .P/N): /

华联威料号 (HLW P/N): R120-11400-G31017

品名规格 (PronameSpec): RJ11-4P4C 全塑带边

送样日期 (Delivery Date): 2022/10/08

承认日期 (Acknowledge Date): 2022/10/08

Approved No:		客 户 Customer	
采 购 部 Purchasing Dept	品 质 部 QC Dept	工 程 部 Engineering Dept	确 认 Approved By
深 圳 市 华 联 威 电 子 科 技 有 限 公 司 SHEN ZHEN SHI HUA LIAN WEI ELECTRONICS TECHNOLOGY CO; LTD.			
业 务 部 Sales Dept	品 管 部 QC Dept	工 程 部 Engineering Dept	核 准 Checked By
吴鑫萍	欠必锋	陈建辉	唐竹君

地址: 深圳市龙华区观澜街道桂香社区观澜桂花路 307 号

TEL: 0755-28888886 28888866

邮箱: hua@hlwconn.com

[Http://www.hlwconn.com](http://www.hlwconn.com)



目 录

Contents

图纸.....	Page03
产品规格书.....	Page04-10
产品检测报告.....	Page11-12
尺寸测试报告.....	Page13
电镀报告.....	Page14
盐雾报告.....	Page15
材质证明.....	Page16-17
SGS.....	Page18-55

REV.	ECN.NO.	APPD.
A	XXXXXXXXXX	yangguifeng

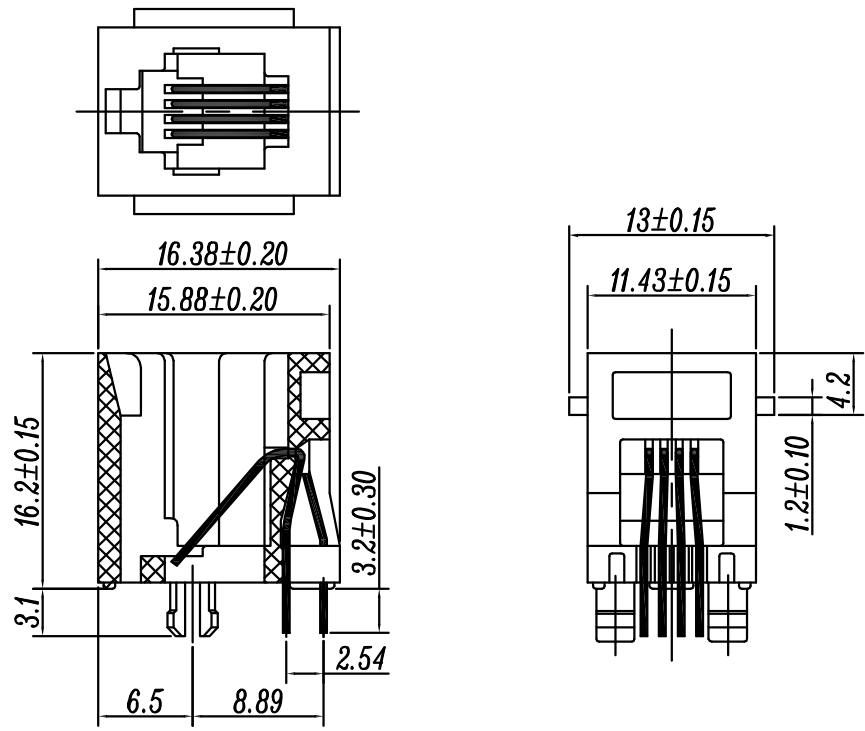

- NOTES:
- MATERIAL:
 - Housing:thermoplastic plastics
 - terminals:Copper Alloy
Gold plated in contact area:
OR Gold Plated overall
 - Shell:Steel&Copper Alloy
Nickel/Tin Plated overall
 - ELECTRICAL CHARACTERISTICS:
 - Rating Current :1.5 Ampere
 - Rating Voltage :125 V Max
 - Contact Resistance:50 Milli ohms
 - Insulation Resistance:500 Mega ohms Min.
 - MECHANICAL CHARACTERISTICS:
 - Connector Mating force: 2.27kgf MAX
 - Durability:750Cycles.
 - ENVIRONMENT CHARACTERISTICS:
 - Operating temperature:-40°C to +85°C
 - Storage temperature:-10°C to +40°C

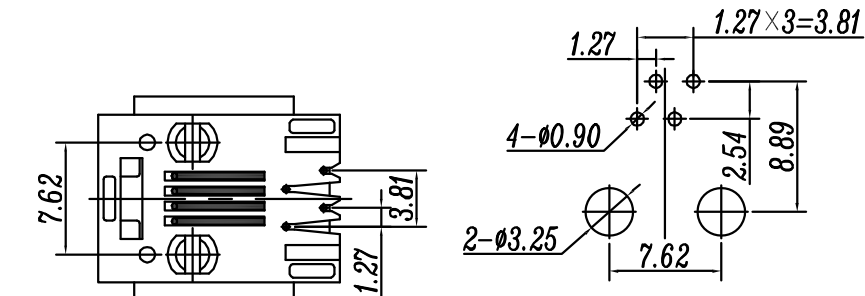

PC Board Layout
Top View

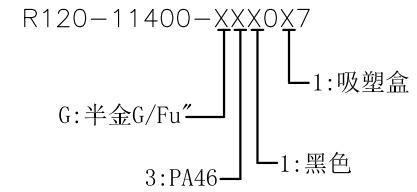

TOLERANCE UNLESS OTHERWISE SPECIFIED		FLW 深圳市华联威电子科技有限公司				
.XXX ±0.10		HUA LIAN WEI TECHNOLOGY ELECTRONICS CO;LTD.				
.XX ±0.20	.X ±3'					
.X ±0.30	.XX' ±2'					
APPROVED		PART NAME:	RJ11 4P4C 全塑带边			
CHECKED		PART No:	R120-11400-G31017	C		
DRAWN	yangguifeng	PROJECTION:	UNIT:	SCALE	SHEET	REV.
DATE	2021.12.01		mm	1:1	1 OF 1	A

RJ45系列产品SPEC

版本版次: C

制定日期 20200707

适用范围 通用

1. Scope (范围)

1.1 Contents(内容)

This specification covers the performance, tests and quality requirements for the Electronics RJ45 Connector.
(此份产品规格适用于RJ45连接器的产品功能, 测试方法及质量要求)

2. Requirements (要求):

2.1 Rating(额定条件)

A. Voltage rating(额定电压):125V AC

B. Current rating(额定电流):0.5A

C. Operation Temperature Range(操作温度范围):-30°C to +80°C

3. Test Condition(测试条件):

3.1 Temperature range(温度范围):-15°C to +35°C

3.2 Humidity range (湿度范围):25% to 85%

4. Test Methods and Requirements:(测试方法及要求)

4.1 Examination of product (产品外观)

4.1.1	Examination of Product 产品外观	(EIA-364-18B) Visual 目视	No peeling off the plating deformation of the base or damage. 不得有电镀层剥落, 塑料变形或破损
-------	--------------------------------	-------------------------------	--

4.2. Electrical Performance(电气性能)

4.2.1	Contact Resistance 接触阻抗	EIA-364-23C Subject mated contacts assembled housing to 20mV maximum 100Ma. Measured from plug side to PCB side. 组装好的端子施以最大电压20mV最大电流100mA从端口处到PCB端测试。	40mΩ Max (Initial) 50 mΩ Max(Final) 初始值最大40mΩ. 最终值最大50 mΩ.
4.2.2	Dielectric Withstanding Voltage (耐电压)	(EIA-364-20C) Mated connectors with 1000±5% VAC for 1 minute 0.5 mA between adjacent contacts or ground. 对组装好的独立端子或接地物之间施加交流1000VAC 0.5mA 电流1 分钟。	One minute hold with no breakdown or flashover. 不能有如跳电、击穿、破裂损坏。
4.2.3	Insulation Resistance 绝缘阻抗	(EIA-364-21C) Mated connectors with 500±10%VDC between adjacent contacts or ground. 对组装好的独立端子或接地物之间施以500±10%VDC的电压测试	500MΩ min (unmated) 没有配对需大于500 MΩ

4.3 Mechanical Performance(机械性能)

4.3.1	Insertion/Withdrawal Force 插入力/拔出力	(EIA-364-13) Insertion and withdrawal speed: 25mm/minute. 插入和拔出的速度为25mm/分	Maximum insertion force 22N 插入力不超过30N(3.0/kg) Withdrawal force 22N max 拔出力不超过30N(3.0/kg)
4.3.2	Durability 寿命测试	(EIA-364-09) Operation Speed:10 To 20cycle/min. Durability cycles:750cycles 测试速度：每分钟10到20个循环，测试次数：750次循环最少	Meet visual requirements,show no physical damage,and meet requirements of additional tests as specified in the product qualification 测试后满足外观要求，无变形损伤.
4.3.3	Vibration 振动	(EIA-364-28条件3) Amplitude:1.52mm P-P or 147m/s ² {15G} Sweep time: 50-2000-50Hz in 20 minutes. Duration: 12 times in each (total of 36 times) X, Y, Z, axes. Electrical load DC 100mA current shall be flowed during the test.(ANSI/EIA-364-28 Condition III) 在直流100毫安通电状态下测试，在X,Y,Z垂直3方向上，频率50-2000-50赫兹（加速度往复20分钟），全振幅1.52mm P-P或147 m/s ² {15G}，每轴12回计36回	Appearance: No damage 外观：无损坏 Discontinuity: 1μ sec Max. 间断性：不超过1微秒
4.3.4	Physical shock 冲击性	(EIA-364-27条件A) Pulse width: 11msec Waveform: Half-sine 490m/s ² (50G) 3 strokes in each X, Y, Z axes. (ANSI/EIA-364-27 condition A) 周期：11msec 冲击波形：正弦半波490m/s ² (50G) 3 循环在X, Y, Z 轴	Appearance: No damage 外观：无损坏 Discontinuity: 1μ sec Max. 间断性：不超过1微秒
4.4 Environmental Performance			
4.4.1	Thermal shock test 冷热冲击	EIA-364-32C条件1) 10 cycles of: a)-55±3℃ for 30 minutes b) +85±3℃ for 30 minutes 10个循环， a)-55±3℃ 30 分钟 b) +85±3℃ 30 分钟	Appearance: No Damage. 外观：没有损坏 Contact Resistance 接触阻抗 Contact: Change from initial Value 30mΩ Max Shell Part: Change from initial Value 50mΩ Max 端子：从初始值开始变化量小于30mΩ 外壳：从初始值开始变化量小于50mΩ

4.4..2	Solder ability 焊锡性	(EIA-364-52) To be sipped in the solder bath 260±5°C Coverage for 3 seconds. 将焊锡脚浸在260±5°C的锡炉中<3秒	The inspected area of each lead must have 95% solder coverage minimum
4.4..3	Humidity 恒温恒湿	(EIA-364-31B) (A) Mate connectors together and perform the test as follows 配对的连接器测试条件 Temperature: +25°C to +85°C(温度: +25°C到+85°C) Relative Humidity: 80% to 90%(相对湿度: 80%到90%) Duration:4 cycles(96 hours) (持续时间: 4个循环共96小时) Upon completion of the test, specimens shall be conditioned ambient room conditions for 24 hours, after which the specified measurements shall be performed. 试验完成后, 样品放置于室温条件中24小时后再进行测试	Appearance: No Damage 外观, 没有损坏
		(EIA-364-31B) (B) Unmated each connector and perform the test as follows. 没有配对的连接器测试条件 Temperature: +25°C to +85°C(温度: +25°C到+85°C) Relative Humidity: 80% to 90%(相对湿度: 80%到90%) Duration:4 cycles(96 hours) (持续时间: 4个循环共96小时) Upon completion of the test, specimens shall be conditioned ambient room conditions for 24 hours, after which the specified measurements shall be performed. 试验完成后, 样品放置于室温条件中24小时后再进行测试	Appearance: No Damage 外观, 没有损坏 Conform to item of dielectric withstanding Voltage and Insulation Resistance. 符合耐电压及绝缘阻抗要求

4.4..4	Salt Spray 盐水喷雾	EIA-364-26B) Tested as below: Temperature:(35±2) °C Humidity:(95-98)%(R.H.) PH:6.5-7.2 It shall be subjected to stand ard atmospheric condition 1hours after removing the salt deposits. It should meet the contact resistance.object non-contact area: Temperature: (35±2) °C Salt-solution(5±1)% Duration time:12hours 测试条件如下: 温度:(35±2) °C 湿度:(95-98)%(R.H.) PH值:6.5-7.2 物体在移出盐水槽后应置于标准大气条件中一个小时后再进行测量动作: 盐水密度: (5±1) % 持续时间: 24小时	No detrimental corrosion(Terminal solder tail unrequested) 产品无氧化, 锈蚀 (端子焊脚镀锡处不作要求)
4.4..5	Cold resistance (Unmated) 冷阻抗	(EIA-364-17B) Unmated connectors and expose to -40±3°C for 96 hours. Upon completion of the exposure period, the test specimens shall be conditioned at ambient room conditions for 1 to 2 hours, after which the specified measurements shall be performed. 没配对的连接器放置于-40±3°C温度中96小时, 当完成实验后, 样品放置一般环境中1到2小时后, 再进行测试	Appearance: No Damage. 外观: 没有损坏
4.4..6	Heat resistance (Unmated) 热阻抗	(EIA-364-17B) Mated connectors and expose to 85±2°C for 96hours. Upon completion of the exposure period, the test specimens shall be conditioned at ambient room conditions for 1 to 2 hours, after which the specified measurements shall be performed. 配对的连接器放置于85±2°C温度中96小时, 当完成实验后, 样品放置一般环境中1到2小时后, 再进行测试	Appearance: No Damage. 外观: 没有损坏

4.4.7	Thermal Aging 高温老化	<p>(EIA-364-31B, Condition 4, Method A) Unmated connectors and expose to +105±2°C for 96 hours. Upon completion of the exposure period, the test specimens shall be conditioned at ambient room conditions for 1 to 2 hours, after which the specified measurements shall be performed.</p> <p>没配对的连接器放置于+105±2°C温度中96小时，当完成实验后，样品放置一般环境中1到2小时后，在进行测试</p>	<p>Appearance: No Damage. 外观：没有损坏</p>
4.4.8	Resistance to Soldering Heat	<p>for wave soldering : mil-std-202f,method 210 A,test condition B 波峰焊: mil-std-202f, method 210 A, 试验条件B Pre-heat : 80°C, 60 Seconds 预热:80°C, 60秒 Temperature : 260 ± 5 °C 温度:260±5°C Immersion duration : 10 ± 1 sec. 浸泡时间:10±1秒。</p> <p>for manual soldering :手动焊接: mil-std-202f,method 210 A,test condition A Pre-heat : No 预热:没有 Temperature : 350 ± 10 °C 温度:350±10°C Immersion duration :3.5±0.5 sec.浸泡时间:3.5±0.5秒</p>	<p>No physical damage shall occur. 不可有损坏</p>

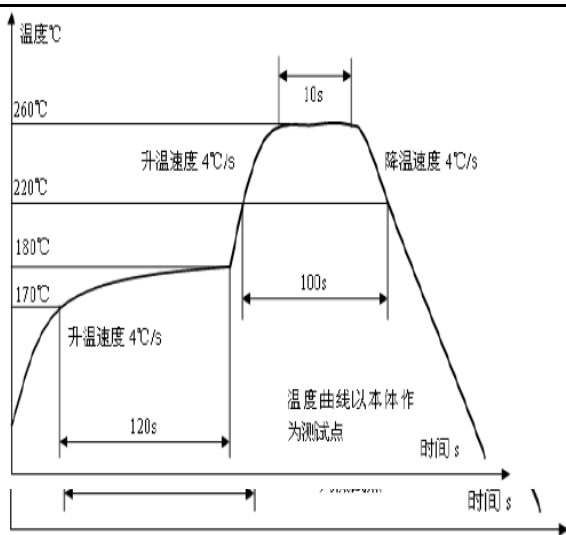

Note 1: Shall meet visual requirements, show no physical damage, and meet requirement of additional tests as specified in the test sequence in Figures 2

说明1: 测试要求不能有物理损坏, 测试依据表格二的顺序进行

3.Product Qualification And Requalification Test:产品测试顺序表 Figure 2

Test or Examination	Test Group													
	A	B	C	D	E	F	G	H	I	J	K	L	M	N
Test Sequence														
4.1.1.Examination of Product 产品外观	1,9	1,3	1,5	1	1,5	1,5	1,5	1,3	1,5	1,5	1,5	1,5	1,5	1
4.2.1.Contact Resistance 接触阻抗	2,8		2,4		2,4	2,4	2,4		2,4	2,4	2,4	2,4	2,4	
4.2.2.Dielectric Withstanding Voltage	3,7													
4.2.3.Insulation Resistance 绝缘阻抗	4,6													
4.3.1.Insertion/Withdrawal force 插拔力		2												
4.3.2.Durability 寿命测试			3											
4.3.3.Vibration 振动性					3									
4.3.4.Physical shock 冲击性						3								
4.4.1.Thermal shock test 冷热冲击							3							
4.4.2.Solderability 焊锡性								2						
4.4.3.Humidity 恒温恒湿	5								3					

4.4.4.Salt Spray 盐水喷雾										3				
4.4.5.Cold resistance 冷阻抗											3			
4.4.6.Heat resistance 热阻抗												3		
4.4.7.Thermal Aging 高温老化													3	
4.4.8.IR-reflow 回流焊测试														2
NO. of Test samples(Min.) 测试样	5	5	5	5	5	5	5	5	5	5	5	5	5	5

NOTE 2: (a) Numbers indicate sequence in which tests are performed.

(b) Discontinuities shall not take place in this test group, during tests.

说明 2: (a)测试依照矩阵要求数量进行。

(b)在测试中，群组测试不能间断

核准：唐竹君

制作人：魏红

測試報告

TEST REPORT

產品名稱 Part Name	RJ11-4P4C全塑帶边	測試日期 Date of Testing	2022.10.05 2022.10.07	報告編號 Report NO.	MD20221007-01
產品型號 Part Name	R120-11400-G31017	樣品數量 Quantity	5PCS	測試環境 Measuring Environment	濕度 Temp:18~21°C 相對濕度RH:49%~57%

一.電性測試 ELECTRICAL TEST

序號 NO.	測試項目 Testing Item	測試條件 Testing Conditions	測試設備 Testing Equipment	規格 SPEC	測試記錄Testing Result					判定Judge	
					1	2	3	4	5	Pass	Fail
1	Contact resistance	Test current:100mA max	DIGITAL MICRO-OHMMETER	50mΩ Max	21.36 mΩ	20.05 mΩ	18.62 mΩ	20.55 mΩ	21.53 mΩ	P	
2	Insulation resistance	Test voltage:500VDC Operation stated:1min	ULTRA HIGH RESISTANCE METER	500MΩ Min	Pass	Pass	Pass	Pass	Pass	P	
3	Dielectric withstand voltage	Test voltage:1000VAC Cut-off current:0.5mA Operation stated:1 min	BREAKDOWN TESTER	No discharge or flashover occur	Pass	Pass	Pass	Pass	Pass	P	

二.機械特性測試 MECHANICAL TEST

序號 NO.	測試項目 Testing Item	測試條件 Testing Conditions	測試設備 Testing Equipment	規格 SPEC	測試記錄Testing Result					判定Judge	
					1	2	3	4	5	Pass	Fail
1	Durability test	Rate:200cycles/hour Total: 750 cycles	LIFE TESTER FOR CONNECTOR	No physical damage	Pass	Pass	Pass	Pass	Pass	P	
2	Mating Force	29.4Newtons maximum at a maximum rare of 7.5mm(0.39") per minute	Insertion force testing machine	3.0kgf Max	Pass	Pass	Pass	Pass	Pass	P	

三.環境特性測試 ENVIRONMENTAL TEST

序號 NO.	測試項目 Testing Item	測試條件 Testing Conditions	測試設備 Testing Equipment	規格 SPEC	測試記錄 Testing Result					判定 Judge	
					1	2	3	4	5	Pass	Fail
1	Humidity-Temperature cycle	Temperature: 40±2°C Humidity: 90~95% Duration:168H	PROGRAM CONTROLLED TEMP. & HUMIDTY CHAMBER	No physical damage	Pass	Pass	Pass	Pass	Pass	P	
2	Heat test	Temperature: 70±2°C Duration:168H	OVEN	No physical damage	Pass	Pass	Pass	Pass	Pass	P	
3	Cold test	Temperature: -25±3°C Duration:168H	PROGRAM CONTROLLED TEMP. & HUMIDTY CHAMBER	No physical damage	Pass	Pass	Pass	Pass	Pass	P	
4	Temperature cycling test	Temperature: -55~85°C Duration:10 cycle	PROGRAM CONTROLLED TEMP. & HUMIDTY CHAMBER	No physical damage	Pass	Pass	Pass	Pass	Pass	P	

四.物理測試 PHYSICAL TEST

序號 NO.	測試項目 Testing Item	測試條件 Testing Conditions	測試設備 Testing Equipment	規格 SPEC	測試記錄 Testing Result					判定 Judge	
					1	2	3	4	5	Pass	Fail
1	Salt spray test	Temperature: 35±2°C Concentration:5±1 % Duration:12H	SALT SPRAY TESTER	No Oxidation	Pass	Pass	Pass	Pass	Pass	P	
2	Resistance to soldering heat test	Temperature: 260°C Duration:3 sec	OVEN	No physical damage	Pass	Pass	Pass	Pass	Pass	P	
3	Solder ability test	Temperature: 260±5°C Duration:5±0.5 sec	CONTROLLED CONSTANT-TEMP SOLDER POT	Soldering area ≥95□	Pass	Pass	Pass	Pass	Pass	P	
判定 Result		<input checked="" type="checkbox"/> 合格 (ACCEPT) <input type="checkbox"/> 不合格 (REJECT)									

核准(Approver): 欠必鋒

測試(Tester): 但芬

檢驗報告

首件檢驗 入庫檢驗 出貨檢驗 客退檢驗 退料檢驗 其他

2022年10月08日 版次:A1

料號	R120-11400-G31017	制令單號	/	送檢單位	工程部	首件製作者	裝配	
品名	RJ11-4P4C全塑帶邊	客戶代號	/	批 量	/	送檢時間	/	
				數 量	5PCS	確認時間	/	
抽樣標準		<input checked="" type="checkbox"/> 單次 <input type="checkbox"/> 雙次		抽樣數 (5PCS)	AQL	CRI:0 MAJ:0.40	MIN:0.65	
MIL-STD-105E(II)		<input checked="" type="checkbox"/> 正常 <input type="checkbox"/> 加嚴 <input type="checkbox"/> 減量			ACC/REJ	0	/	/
不良數: CRI (/) MAJ (/) MIN (/)						不良率(%)		/

NO.	檢驗項目 單位:MM/G	檢測 儀器	檢 驗 記 錄					品管判定		CRI	MAJ	MIN	備注
			1	2	3	4	5	AC	RE				
	16.38±0.20	D	16.38	16.39	16.40	16.38	16.40	√					
	6.5±0.30	D	6.53	6.55	6.54	6.55	6.50	√					
	8.89±0.20	D	8.90	8.89	8.89	8.87	8.90	√					
	16.2±0.15	D	16.20	16.23	16.24	16.23	16.24	√					
	2.54±0.20	D	2.56	2.55	2.56	2.54	2.56	√					
	3.2±0.30	D	3.20	3.23	3.23	3.25	3.25	√					
	13±0.15	D	13.02	13.01	13.00	13.03	13.04	√					
	11.43±0.15	D	11.42	11.43	11.42	11.43	11.44	√					
	7.62±0.20	D	7.62	7.63	7.65	7.62	7.63	√					

檢驗依據: 《《工程圖紙》》 《《檢驗規範》》 《《承認書》》 樣品 其它

檢測儀器:A游標卡尺 B千分尺 C厚薄儀 D投影鏡 E放大鏡 F顯微鏡 G錫爐 H插拔力器 I間位尺 J其它

品保判定:					
核 准 APP	欠必鋒	審 核 CHK	/	檢驗員 INSPBY	但芬

保存期限:三年 保存部門:品保部 QR-M-003

品名:RJ11-4P4C全塑带边(端子)		版次:A.0			
电镀规格:Ni30u",Sn100u",Au G/Fu"		日期:2022-09-04			
页次:1/1					
厂商:同华					
测试设备:CMI X-射线膜厚测试仪					
1、底层电镀测试(Ni)					
数据	测试标准	实测值	判定	测试日期	测试时间
1	30u"MIN	50.5u"	OK	2022/9/4	10:20:15
2	30u"MIN	56.3u"	OK	2022/9/4	10:20:17
3	30u"MIN	67.5u"	OK	2022/9/4	10:20:19
4	30u"MIN	62.4u"	OK	2022/9/4	10:20:21
2、表层电镀测试(Sn)					
数据	测试标准	实测值	判定	测试日期	测试时间
1	100u"MIN	105.3u"	OK	2022/9/4	10:25:10
2	100u"MIN	104.7u"	OK	2022/9/4	10:25:12
3	100u"MIN	105.9u"	OK	2022/9/4	10:25:14
4	100u"MIN	107.4u"	OK	2022/9/4	10:25:16
3、表层电镀测试(Au)					
数据	测试标准	实测值	判定	测试日期	测试时间
1	0.5u"MIN	0.52u"	OK	2022/9/4	10:30:32
2	0.5u"MIN	0.55u"	OK	2022/9/4	10:30:34
3	0.5u"MIN	0.53u"	OK	2022/9/4	10:30:36
4	0.5u"MIN	0.54u"	OK	2022/9/4	10:30:38

核准: 欠必锋

审核: 李娟

检验员: 但芬



深圳市华联威电子科技有限公司

盐水喷雾实验报告

试验方法	盐水喷雾腐蚀试验法	参考资料	MIL-STD-1345
METHOD	NEUTRL SALT SPRAY CORROSION TEST	REF	
客户		试验起始日期	2022年10月07日 20:00 时起
		DATE	2022年10月08日 08:00 时止
样品名称	RJ11-4P4C全塑带边	试验数量	5PCS
P/N	R120-11400-G31017	QTY	

试验条件 (TEST CONDITION)

- 1、盐水溶解 (SALT SOLUTION: 浓度 $50 \pm 10\text{g/L}$, PH值6.5-7.2).
- 2、试验室温度 (TEMP. IN THE SPRAY CHAMBER): $35 \pm 1^\circ\text{C}$.
- 3、盐水桶温度 (TEMP. OF SALT SOLUTION TANK): $35 \pm 1^\circ\text{C}$.
- 4、压力桶温度 (TEMP. OF AIR SUPPLY): $47 \pm 1^\circ\text{C}$.
- 5、试验室相对湿度 (R.H IN THE CHAMBER) 85%.
- 6、压缩空气压力 (COMPRESSED AIR PRESSURE): $1.00 \pm 0.01\text{Kg/cm}^2$.
- 7、样品放置位置 (SPECIMEN SUPPORTED ANGLE): 尼龙绳吊挂 $70^\circ - 90^\circ$.
- 8、喷雾收集量 (COLLECT RATE OF SALT SOLUTION) $1-2\text{mL}/(8\text{ cm}^2\text{hr})$.
- 9、盐雾测试时间: 12小时 (H)

判定方法 (ADJUSTED METHOD)

试验后以20倍放大镜观察、无蓝、绿色腐蚀物之现象 (不包含折弯处), 即判定合格. (Inspect the specimen at 20 magnification no blue or green corrosion products are acceptable)

样品序号	试验后现象	判定
	PHENOMENON AFTER TEST	COMMENT
1	无蓝、绿色腐蚀物之现象	OK
2	无蓝、绿色腐蚀物之现象	OK
3	无蓝、绿色腐蚀物之现象	OK
4	无蓝、绿色腐蚀物之现象	OK
5	无蓝、绿色腐蚀物之现象	OK

核准: 欠必锋

审核: 李娟

试验员: 但芬

深圳市优化新材料科技有限公司

材料安全数据表 (MSDS)

1	供應商資料	物品名稱 : PA46 4630							
		供應商名稱 : 深圳市优化新材料科技有限公司							
		地址 : 深圳市光明新区公明镇塘尾银海工业区							
		公司電話 : 0755-27190258				傳真 : 0755-27199258			
		緊急聯絡人 : 陈武				緊急聯繫電話 : 0755-27190258			
2	成份辨識資料	中英文名稱 Shenzhen Youhua New Material Technology Co., LTD							
		成份名稱	化學式	含量(%)	化學文摘社登記號碼CAS NO:	濃度或濃度範圍(成份百分比)			危害物質分類及圖示
						時量平均容許濃度	短時間時量平均容許濃度	最高容許濃	
		PA46树脂	(C ₁₀ H ₁₈ N ₂ O ₂)	45%	50327-22-5				无
		阻燃剂	(C ₈ H ₅ Br ₃) _n	20%	88497-56-7				无
		色母	无	1%	无				无
		其它助剂	无	4%	无				无
		玻璃纤维	SiO ₂	30%	65997-17-3				
3	健康、環境、物理及化學危害	健康危害效應: 无							
		環境影響: 无							
		物理性及化學興危害: 无							
		特殊危害: 无							
		主要症狀: 无							
物品危害分類: 无									
4	急救措施	不同暴露途徑之急救方法	吸入 :		当吸入加热所产生气体时, 应立即移止通风良好之处, 如有必要送医治疗				
			皮膚接觸 :		若接触到高温物料, 立即以大量的冷水冲洗并送医				
			眼睛接觸 :		若接触到高温物料, 立即以大量的冷水冲洗并送医				
			食入 :		尽量呕吐出食入物, 如有必要则送医治疗				
			最重要危害效應:		无				
			對急救人員防護:		无				
			對醫師之提示:		无				
5	滅火措施	適用滅火器: 干粉灭火介质的灭火器							
		滅火時可能遭遇特殊危害: 在280°C以上可能产生一氧化碳、溴化氢等, 其他分解产物氧化物视火情而定							
		特殊滅火程序: 無							
		消防人員之特殊防護設備: 穿着防护设备							
6	洩漏處理方法	個人應注意事項: 工作后要洗手							
		洩漏處理方法: 选择合适的器械处理							
		清理方法: 收集到容器中即可, 可回收加工处理。							
7	安全處置與儲存方法	作业: 作业时佩带防护手套及防尘口罩, 避免粉尘由口鼻吸入							
		儲存: 应存于干燥及通风良好之处							

8	暴露預防措施	工程控制: 确保工作场所通风, 加工时烟尘需抽走	
		參數控制: 无	
		個人防護設備:	
		呼吸防護: 防粉尘用防护面罩	眼睛防護: 安全护目眼睛
		手部防護: 隔热手套	皮膚及身體防護: 长袖工作服及安全鞋
衛生措施: 无			
9	物理及化學性質	物質狀態: 固体	形狀: 颗粒
		顏色: 黑色	氣味: 烧焦味和带芹菜味
		PH值: ND	沸點: ND
		分解溫度: >350°C	閃火點: >400°C
			測試方法: ASTM
		自然溫度: >450°C	爆炸界限: ND
		蒸氣壓: ND	蒸氣密度: ND
密度: 1.60-1.65	溶解度: ND		
10	安定性及反應性	安定性: 稳定	
		特殊狀況下可能危害反應: 无	
		應避免狀況: 加热不能超350°C	
		應避免之物質: 强酸, 强碱, 强氧化剂	
危害分解物: toxic gases(Nitrogen oxides).(Carbon oxides (CO+ CO2)).(Hydrogen cyanide)			
11	毒性資料	急毒性: 无	致敏感性: 无
		局部效應: 无	
		慢毒性或長期毒性: 无	
		特殊效應: 无	
12	生態資料	可能環境影響/環境流佈: 无	
13	廢棄處置方法	廢棄處置方法: 回收利用, 视为废弃物烧掉	
14	運送資料	國際運送規定: 无	
		聯合國編號: 无	
		國內運送規定: 无	
		特殊運送方法及注意事項: 干燥防潮	
15	法規資料	適用法規: 本品符合相关产品的法规要求, 不属于要求安全许可生产的产品。	
	製表單位:	名稱: 深圳市优化新材料科技有限公司	
		地址: 深圳市光明新区公明镇塘尾银海工业区	
	製表人: 陈武	職稱: 工程	
	製表日期: 2021-07-05	電話: 0755-27190258	

东莞市金思拓金属有限公司
产品质量证明书

产品批号

QR/ZHT-8.2.4-14

产品名称		牌号	规格	状态	厚度公差		宽度公差	
磷铜		C5191	0.46	H	0.01		+ 0/ - 0.01mm	
化学成份	锡sn	磷p	铝AL	锌Zn	镍Ni	铁Fe	铅Pb	铜Cu
	5.704	0.149	≤0.002	/	0.263	≤0.02	≤0.01	余量
物理性能	抗拉强度	伸长率		维氏硬度H		数 量		
	715	8		222		1卷		15kg
技术条件	符合	GB/T2059-2000		标准				
化学成份	符合	GB/T5231-2001						

Test Report

No. CANEC2222380712

Date: 26 Oct 2022

Page 1 of 6

Client Name : SHENZHEN HUALIANWEI ELECTRONICS TECHNOLOGY CO.,LTD

Client Address : 101, 201, PLANT 1, NO.307, GUANLAN GUIHUA ROAD, GUIXIANG COMMUNITY, GUANLAN SUB-DISTRICT, LONGHUA DISTRICT, SHENZHEN CITY, GUANGDONG PROVINCE, CHINA

Sample Name : PA46 black plastic

Model No. : PA46 black plastic

Client Ref. Info. : Used for USB series, HDMI series, RJ series, 1394 series, MICRO series, MINI series, DISPLAYPORT series, VGA series, DVI series, TYPE-C series, JACK series

The above sample(s) and information were provided by the client.

SGS Job No. : CP22-057100 - GZ

Date of Sample Received : 20 Oct 2022

Testing Period : 20 Oct 2022 - 26 Oct 2022

Test Requested : Selected test(s) as requested by the client.

Test Method(s) : Please refer to next page(s).

Test Result(s) : Please refer to next page(s).

Result Summary :

Test Requested	Conclusion
EU RoHS Directive (EU) 2015/863 amending Annex II to Directive 2011/65/EU- Lead, Mercury, Cadmium, Hexavalent chromium, Polybrominated biphenyls (PBBs), Polybrominated diphenyl ethers (PBDEs), Bis(2-ethylhexyl) phthalate (DEHP), Butyl benzyl phthalate (BBP), Dibutyl phthalate (DBP) and Diisobutyl phthalate (DIBP)	PASS

Signed for and on behalf of
SGS-CSTC Standards Technical Services Co., Ltd. Guangzhou Branch

Dongyu Xie

Dongyu Xie
Approved Signatory

scan to see the report



054B87EA



Test Report

No. CANEC2222380712

Date: 26 Oct 2022

Page 2 of 6

Test Result(s) :

Test Part Description :

Specimen No.	SGS Sample ID	Description
SN1	CAN22-223807.012	Black plastic

Remarks :

- (1) 1 mg/kg = 0.0001%
- (2) MDL = Method Detection Limit
- (3) ND = Not Detected (< MDL)
- (4) "-" = Not Regulated

EU RoHS Directive (EU) 2015/863 amending Annex II to Directive 2011/65/EU- Lead, Mercury, Cadmium, Hexavalent chromium, Polybrominated biphenyls (PBBs), Polybrominated diphenyl ethers (PBDEs), Bis(2-ethylhexyl) phthalate (DEHP), Butyl benzyl phthalate (BBP), Dibutyl phthalate (DBP) and Diisobutyl phthalate (DIBP)

Test Method : With reference to IEC 62321-4:2013+A1:2017, IEC 62321-5:2013, IEC 62321-7-2:2017 , IEC 62321-6:2015 and IEC 62321-8:2017, analyzed by ICP-OES , UV-Vis and GC-MS .

Test Item(s)	Limit	Unit	MDL	012
Cadmium (Cd)	100	mg/kg	2	ND
Lead (Pb)	1000	mg/kg	2	5
Mercury (Hg)	1000	mg/kg	2	ND
Hexavalent Chromium (CrVI)	1000	mg/kg	8	ND
Sum of PBBs	1000	mg/kg	-	ND
Monobromobiphenyl	-	mg/kg	5	ND
Dibromobiphenyl	-	mg/kg	5	ND
Tribromobiphenyl	-	mg/kg	5	ND
Tetrabromobiphenyl	-	mg/kg	5	ND
Pentabromobiphenyl	-	mg/kg	5	ND
Hexabromobiphenyl	-	mg/kg	5	ND
Heptabromobiphenyl	-	mg/kg	5	ND
Octabromobiphenyl	-	mg/kg	5	ND
Nonabromobiphenyl	-	mg/kg	5	ND
Decabromobiphenyl	-	mg/kg	5	ND
Sum of PBDEs	1000	mg/kg	-	ND
Monobromodiphenyl ether	-	mg/kg	5	ND
Dibromodiphenyl ether	-	mg/kg	5	ND
Tribromodiphenyl ether	-	mg/kg	5	ND
Tetrabromodiphenyl ether	-	mg/kg	5	ND



Unless otherwise agreed in writing, this document is issued by the Company subject to its General Conditions of Service printed overleaf, available on request or accessible at <http://www.sgs.com/en/Terms-and-Conditions.aspx> and, for electronic format documents, subject to Terms and Conditions for Electronic Documents at <http://www.sgs.com/en/Terms-and-Conditions/Terms-e-Documents.aspx>. Attention is drawn to the limitation of liability, indemnification and jurisdiction issues defined therein. Any holder of this document is advised that information contained hereon reflects the Company's findings at the time of its intervention only and within the limits of Client's instructions, if any. The Company's sole responsibility is to its Client and this document does not exonerate parties to a transaction from exercising all their rights and obligations under the transaction documents. This document cannot be reproduced except in full, without prior written approval of the Company. Any unauthorized alteration, forgery or falsification of the content or appearance of this document is unlawful and offenders may be prosecuted to the fullest extent of the law. Unless otherwise stated the results shown in this test report refer only to the sample(s) tested.

Attention: To check the authenticity of testing / inspection report & certificate, please contact us at telephone: (86-755) 8307 1443, or email: CN.Doccheck@sgs.com

Test Report

No. CANEC2222380712

Date: 26 Oct 2022

Page 3 of 6

<u>Test Item(s)</u>	<u>Limit</u>	<u>Unit</u>	<u>MDL</u>	<u>012</u>
Pentabromodiphenyl ether	-	mg/kg	5	ND
Hexabromodiphenyl ether	-	mg/kg	5	ND
Heptabromodiphenyl ether	-	mg/kg	5	ND
Octabromodiphenyl ether	-	mg/kg	5	ND
Nonabromodiphenyl ether	-	mg/kg	5	ND
Decabromodiphenyl ether	-	mg/kg	5	ND
Dibutyl phthalate (DBP)	1000	mg/kg	50	ND
Butyl benzyl phthalate (BBP)	1000	mg/kg	50	ND
Bis (2-ethylhexyl) phthalate (DEHP)	1000	mg/kg	50	ND
Diisobutyl Phthalates (DIBP)	1000	mg/kg	50	ND

Notes :

- (1) The maximum permissible limit is quoted from RoHS Directive (EU) 2015/863.
- (2) IEC 62321 series is equivalent to EN 62321 series
- (3) The restriction of DEHP, BBP, DBP and DIBP shall apply to medical devices, including in vitro medical devices, and monitoring and control instruments, including industrial monitoring and control instruments, from 22 July 2021.

Unless otherwise stated, the decision rule for conformity reporting is based on Binary Statement for Simple Acceptance Rule ($w=0$) stated in ILAC-G8:09/2019.



Unless otherwise agreed in writing, this document is issued by the Company subject to its General Conditions of Service printed overleaf, available on request or accessible at <http://www.sgs.com/en/Terms-and-Conditions.aspx> and, for electronic format documents, subject to Terms and Conditions for Electronic Documents at <http://www.sgs.com/en/Terms-and-Conditions/Terms-e-Documents.aspx>. Attention is drawn to the limitation of liability, indemnification and jurisdiction issues defined therein. Any holder of this document is advised that information contained hereon reflects the Company's findings at the time of its intervention only and within the limits of Client's instructions, if any. The Company's sole responsibility is to its Client and this document does not exonerate parties to a transaction from exercising all their rights and obligations under the transaction documents. This document cannot be reproduced except in full, without prior written approval of the Company. Any unauthorized alteration, forgery or falsification of the content or appearance of this document is unlawful and offenders may be prosecuted to the fullest extent of the law. Unless otherwise stated the results shown in this test report refer only to the sample(s) tested.

Attention: To check the authenticity of testing / inspection report & certificate, please contact us at telephone: (86-755) 8307 1443, or email: CN.Doccheck@sgs.com

ATTACHMENTS

Pb/Cd/Hg/Cr⁶⁺/PBBs/PBDEs Testing Flow Chart

1) These samples were dissolved totally by pre-conditioning method according to below flow chart. (Cr⁶⁺ and PBBs/PBDEs test method excluded).

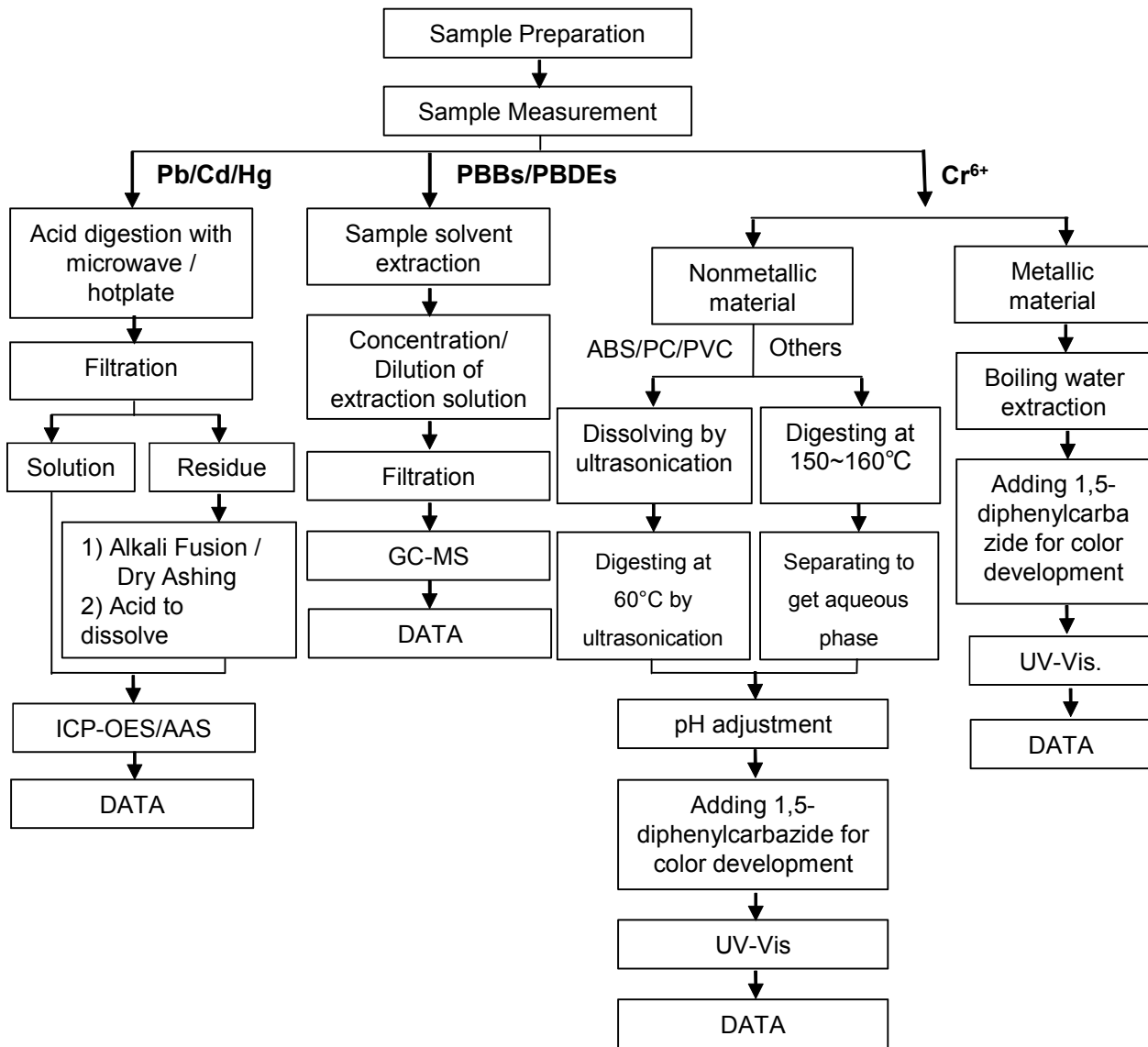

ATTACHMENTS

Phthalates Testing Flow Chart

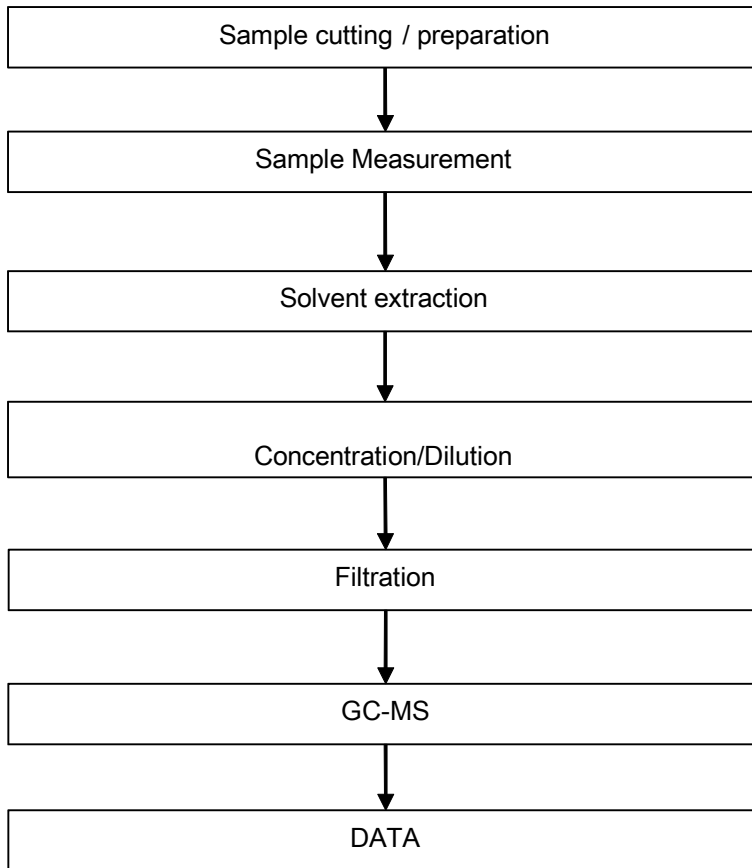

Unless otherwise agreed in writing, this document is issued by the Company subject to its General Conditions of Service printed overleaf, available on request or accessible at <http://www.sgs.com/en/Terms-and-Conditions.aspx> and, for electronic format documents, subject to Terms and Conditions for Electronic Documents at <http://www.sgs.com/en/Terms-and-Conditions/Terms-e-Document.aspx>. Attention is drawn to the limitation of liability, indemnification and jurisdiction issues defined therein. Any holder of this document is advised that information contained hereon reflects the Company's findings at the time of its intervention only and within the limits of Client's instructions, if any. The Company's sole responsibility is to its Client and this document does not exonerate parties to a transaction from exercising all their rights and obligations under the transaction documents. This document cannot be reproduced except in full, without prior written approval of the Company. Any unauthorized alteration, forgery or falsification of the content or appearance of this document is unlawful and offenders may be prosecuted to the fullest extent of the law. Unless otherwise stated the results shown in this test report refer only to the sample(s) tested.

Attention: To check the authenticity of testing / inspection report & certificate, please contact us at telephone: (86-755) 8307 1443, or email: CN_Doccheck@sgs.com

Sample photo:



SGS authenticate the photo on original report only

*** End of Report ***



Test Report

No. CANEC2222380703

Date: 26 Oct 2022

Page 1 of 4

Client Name : SHENZHEN HUALIANWEI ELECTRONICS TECHNOLOGY CO.,LTD

Client Address : 101, 201, PLANT 1, NO.307, GUANLAN GUIHUA ROAD, GUIXIANG COMMUNITY, GUANLAN SUB-DISTRICT, LONGHUA DISTRICT, SHENZHEN CITY, GUANGDONG PROVINCE, CHINA

Sample Name : Phosphor copper terminal

Model No. : Phosphor copper terminal after plating

Client Ref. Info. : Used for USB series, HDMI series, RJ series, 1394 series, MICRO series, MINI series, DISPLAYPORT series, VGA series, DVI series, TYPE-C series, JACK series

The above sample(s) and information were provided by the client.

SGS Job No. : CP22-057100 - GZ

Date of Sample Received : 20 Oct 2022

Testing Period : 20 Oct 2022 - 26 Oct 2022

Test Requested : Selected test(s) as requested by the client.

Test Method(s) : Please refer to next page(s).

Test Result(s) : Please refer to next page(s).

Result Summary :

Test Requested	Conclusion
EU RoHS Directive (EU) 2015/863 amending Annex II to Directive 2011/65/EU- Lead, Mercury, Cadmium and Hexavalent chromium	PASS

Signed for and on behalf of
SGS-CSTC Standards Technical Services Co., Ltd. Guangzhou Branch

Dongyu Xie

Dongyu Xie
Approved Signatory

scan to see the report



12DD8E3F



Test Report

No. CANEC2222380703

Date: 26 Oct 2022

Page 2 of 4

Test Result(s) :

Test Part Description :

Specimen No.	SGS Sample ID	Description
SN1	CAN22-223807.003	Silver-grey/brassy metal

Remarks :

- (1) 1 mg/kg = 0.0001%
- (2) MDL = Method Detection Limit
- (3) ND = Not Detected (< MDL)
- (4) "-" = Not Regulated

EU RoHS Directive (EU) 2015/863 amending Annex II to Directive 2011/65/EU- Lead, Mercury, Cadmium and Hexavalent chromium

Test Method : With reference to IEC 62321-4:2013+A1:2017, IEC 62321-5:2013, IEC 62321-7-1:2015, analyzed by ICP-OES and UV-Vis .

Test Item(s)	Limit	Unit	MDL	003
Cadmium (Cd)	100	mg/kg	2	ND
Lead (Pb)	1000	mg/kg	2	29
Mercury (Hg)	1000	mg/kg	2	ND
Hexavalent Chromium (Cr(VI))▼	-	µg/cm ²	0.10	ND

Notes :

- (1) The maximum permissible limit is quoted from RoHS Directive (EU) 2015/863.
 - (2) IEC 62321 series is equivalent to EN 62321 series
 - (3) ▼= a. The sample is positive for CrVI if the CrVI concentration is greater than 0.13 µg/cm². The sample coating is considered to contain CrVI
 b. The sample is negative for CrVI if CrVI is ND (concentration less than 0.10 µg/cm²). The coating is considered a non-CrVI based coating
 c. The result between 0.10 µg/cm² and 0.13 µg/cm² is considered to be inconclusive - unavoidable coating variations may influence the determination
- Information on storage conditions and production date of the tested sample is unavailable and thus Cr(VI) results represent status of the sample at the time of testing.

Unless otherwise stated, the decision rule for conformity reporting is based on Binary Statement for Simple Acceptance Rule ($w=0$) stated in ILAC-G8:09/2019.



ATTACHMENTS

Pb/Cd/Hg/Cr⁶⁺ Testing Flow Chart

1) These samples were dissolved totally by pre-conditioning method according to below flow chart. (Cr⁶⁺ test method excluded).

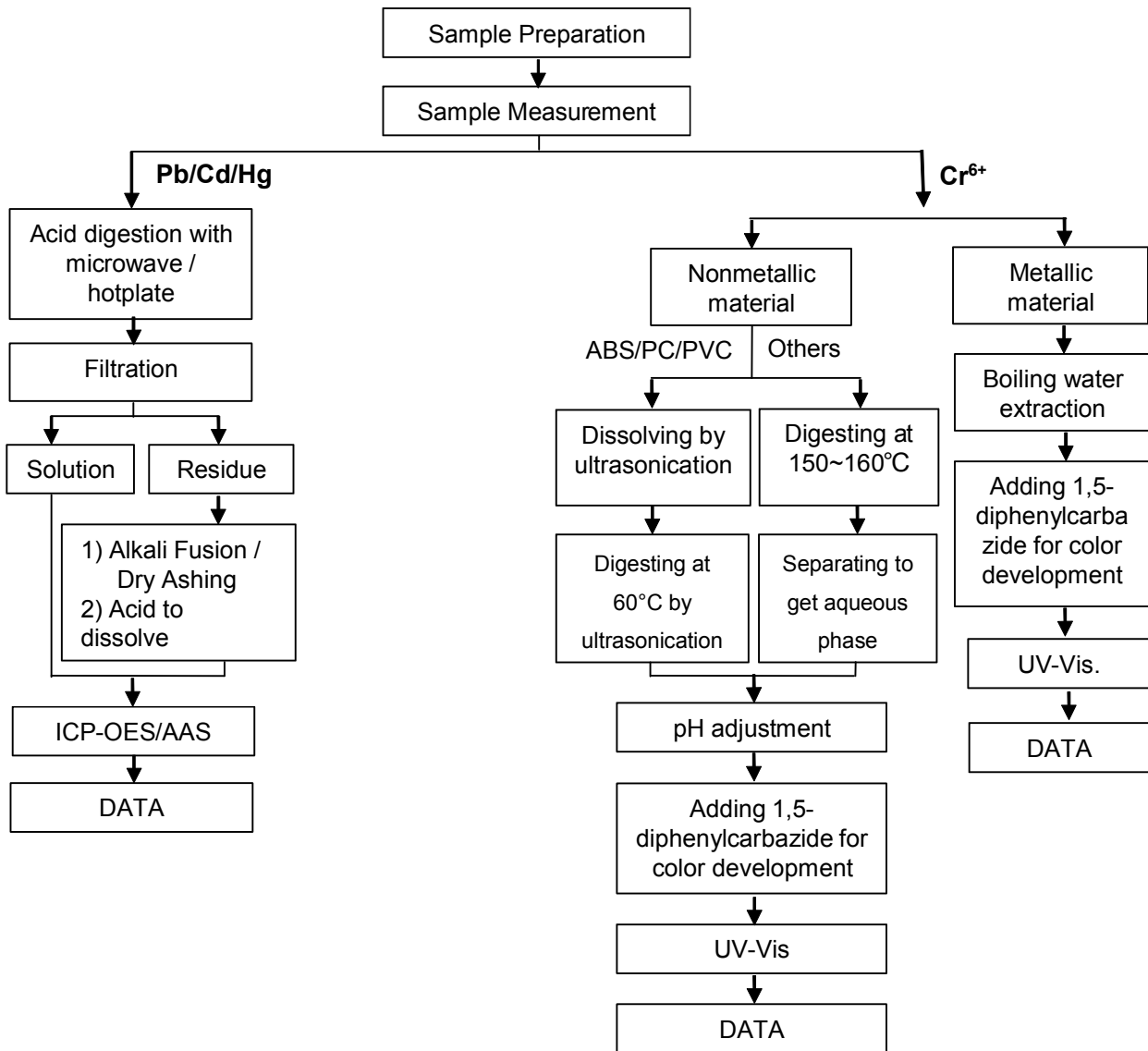

Unless otherwise agreed in writing, this document is issued by the Company subject to its General Conditions of Service printed overleaf, available on request or accessible at <http://www.sgs.com/en/Terms-and-Conditions.aspx> and, for electronic format documents, subject to Terms and Conditions for Electronic Documents at <http://www.sgs.com/en/Terms-and-Conditions/Terms-e-Documents.aspx>. Attention is drawn to the limitation of liability, indemnification and jurisdiction issues defined therein. Any holder of this document is advised that information contained hereon reflects the Company's findings at the time of its intervention only and within the limits of Client's instructions, if any. The Company's sole responsibility is to its Client and this document does not exonerate parties to a transaction from exercising all their rights and obligations under the transaction documents. This document cannot be reproduced except in full, without prior written approval of the Company. Any unauthorized alteration, forgery or falsification of the content or appearance of this document is unlawful and offenders may be prosecuted to the fullest extent of the law. Unless otherwise stated the results shown in this test report refer only to the sample(s) tested.

Attention: To check the authenticity of testing / inspection report & certificate, please contact us at telephone: (86-755) 8307 1443, or email: CN.Doccheck@sgs.com

Sample photo:



SGS authenticate the photo on original report only

*** End of Report ***



Test Report

No. CANEC2218227002

Date: 30 Aug 2022

Page 1 of 8

Client Name : SHENZHEN CITY TONGHUA INDUSTRY CO.,LTD

Client Address : TONGHUA MANSIN TONGLE XINBU VILLANG TOWN SHENZHEN CITY CHINA

Sample Name : Gold (AU)

The above sample(s) and information were provided by the client.

SGS Job No. : CP22-047169 - SZ
 Date of Sample Received : 25 Aug 2022
 Testing Period : 25 Aug 2022 - 30 Aug 2022
 Test Requested : Selected test(s) as requested by the client.
 Test Method(s) : Please refer to next page(s).
 Test Result(s) : Please refer to next page(s).

Result Summary :

Test Requested	Conclusion
EU RoHS Directive (EU) 2015/863 amending Annex II to Directive 2011/65/EU- Lead, Mercury, Cadmium, Hexavalent chromium, Polybrominated biphenyls (PBBs), Polybrominated diphenyl ethers (PBDEs), Bis(2-ethylhexyl) phthalate (DEHP), Butyl benzyl phthalate (BBP), Dibutyl phthalate (DBP) and Diisobutyl phthalate (DIBP)	PASS
Perfluorooctanoic acid (PFOA) and its salts & Perfluorooctane sulfonates (PFOS) and its derivatives	See Results

Signed for and on behalf of
 SGS-CSTC Standards Technical Services Co., Ltd. Guangzhou Branch

Dongyu Xie

Dongyu Xie
 Approved Signatory

scan to see the report



9B230D54



Test Report

No. CANEC2218227002

Date: 30 Aug 2022

Page 2 of 8

Test Result(s) :

Test Part Description :

Specimen No.	SGS Sample ID	Description
SN1	CAN22-182270.002	Gold plated metal

Remarks :

- (1) 1 mg/kg = 0.0001%
- (2) MDL = Method Detection Limit
- (3) ND = Not Detected (< MDL)
- (4) "-" = Not Regulated

EU RoHS Directive (EU) 2015/863 amending Annex II to Directive 2011/65/EU- Lead, Mercury, Cadmium, Hexavalent chromium, Polybrominated biphenyls (PBBs), Polybrominated diphenyl ethers (PBDEs), Bis(2-ethylhexyl) phthalate (DEHP), Butyl benzyl phthalate (BBP), Dibutyl phthalate (DBP) and Diisobutyl phthalate (DIBP)

Test Method : With reference to IEC 62321-4:2013+A1:2017, IEC 62321-5:2013, IEC 62321-7-1:2015 , IEC 62321-6:2015 and IEC 62321-8:2017, analyzed by ICP-OES , UV-Vis and GC-MS .

<u>Test Item(s)</u>	<u>Limit</u>	<u>Unit</u>	<u>MDL</u>	<u>002</u>
Cadmium (Cd)	100	mg/kg	2	ND
Lead (Pb)	1000	mg/kg	2	50
Mercury (Hg)	1000	mg/kg	2	ND
Hexavalent Chromium (Cr(VI))▼	-	µg/cm ²	0.10	ND
Sum of PBBs	1000	mg/kg	-	ND
Monobromobiphenyl	-	mg/kg	5	ND
Dibromobiphenyl	-	mg/kg	5	ND
Tribromobiphenyl	-	mg/kg	5	ND
Tetrabromobiphenyl	-	mg/kg	5	ND
Pentabromobiphenyl	-	mg/kg	5	ND
Hexabromobiphenyl	-	mg/kg	5	ND
Heptabromobiphenyl	-	mg/kg	5	ND
Octabromobiphenyl	-	mg/kg	5	ND
Nonabromobiphenyl	-	mg/kg	5	ND
Decabromobiphenyl	-	mg/kg	5	ND
Sum of PBDEs	1000	mg/kg	-	ND
Monobromodiphenyl ether	-	mg/kg	5	ND
Dibromodiphenyl ether	-	mg/kg	5	ND
Tribromodiphenyl ether	-	mg/kg	5	ND
Tetrabromodiphenyl ether	-	mg/kg	5	ND



Unless otherwise agreed in writing, this document is issued by the Company subject to its General Conditions of Service printed overleaf, available on request or accessible at <http://www.sgs.com/en/Terms-and-Conditions.aspx> and, for electronic format documents, subject to Terms and Conditions for Electronic Documents at <http://www.sgs.com/en/Terms-and-Conditions/Terms-e-Document.aspx>. Attention is drawn to the limitation of liability, indemnification and jurisdiction issues defined therein. Any holder of this document is advised that information contained hereon reflects the Company's findings at the time of its intervention only and within the limits of Client's instructions, if any. The Company's sole responsibility is to its Client and this document does not exonerate parties to a transaction from exercising all their rights and obligations under the transaction documents. This document cannot be reproduced except in full, without prior written approval of the Company. Any unauthorized alteration, forgery or falsification of the content or appearance of this document is unlawful and offenders may be prosecuted to the fullest extent of the law. Unless otherwise stated the results shown in this test report refer only to the sample(s) tested.

Attention: To check the authenticity of testing /inspection report & certificate, please contact us at telephone: (86-755) 8307 1443, or email: CN.Doccheck@sgs.com

Test Report

No. CANEC2218227002

Date: 30 Aug 2022

Page 3 of 8

<u>Test Item(s)</u>	<u>Limit</u>	<u>Unit</u>	<u>MDL</u>	<u>002</u>
Pentabromodiphenyl ether	-	mg/kg	5	ND
Hexabromodiphenyl ether	-	mg/kg	5	ND
Heptabromodiphenyl ether	-	mg/kg	5	ND
Octabromodiphenyl ether	-	mg/kg	5	ND
Nonabromodiphenyl ether	-	mg/kg	5	ND
Decabromodiphenyl ether	-	mg/kg	5	ND
Dibutyl phthalate (DBP)	1000	mg/kg	50	ND
Butyl benzyl phthalate (BBP)	1000	mg/kg	50	ND
Bis (2-ethylhexyl) phthalate (DEHP)	1000	mg/kg	50	ND
Diisobutyl Phthalates (DIBP)	1000	mg/kg	50	ND

Notes :

- (1) The maximum permissible limit is quoted from RoHS Directive (EU) 2015/863.
- (2) IEC 62321 series is equivalent to EN 62321 series
- (3) ▼= a. The sample is positive for CrVI if the CrVI concentration is greater than 0.13 µg/cm². The sample coating is considered to contain CrVI
 b. The sample is negative for CrVI if CrVI is ND (concentration less than 0.10 µg/cm²). The coating is considered a non-CrVI based coating
 c. The result between 0.10 µg/cm² and 0.13 µg/cm² is considered to be inconclusive - unavoidable coating variations may influence the determination
 Information on storage conditions and production date of the tested sample is unavailable and thus Cr(VI) results represent status of the sample at the time of testing.

Perfluorooctanoic acid (PFOA) and its salts & Perfluorooctane sulfonates (PFOS) and its derivatives

Test Method : With reference to CEN/TS15968:2010, analysis was performed by LC-MS or LC-MS/MS.

<u>Test Item(s)</u>	<u>CAS NO.</u>	<u>Unit</u>	<u>MDL</u>	<u>002</u>
Perfluorooctanoic acid (PFOA) and its salts+	335-67-1	mg/kg	0.010	ND
Perfluorooctane sulfonates (PFOS) ^	1763-23-1	mg/kg	0.010	ND
Perfluorooctane Sulfonamide (PFOSA)	754-91-6	mg/kg	0.010	ND
N-methylperfluoro-1-octanesulfonamide(MeFOSA)	31506-32-8	mg/kg	0.010	ND
N-ethylperfluoro-1-octanesulfonamide (EtFOSA)	4151-50-2	mg/kg	0.010	ND
2-(N-methylperfluoro-1-octanesulfonamido)-ethanol(MeFOSE)	24448-09-7	mg/kg	0.010	ND
2-(N-ethylperfluoro-1-octanesulfonamido)-ethanol(EtFOSE)	1691-99-2	mg/kg	0.010	ND
Perfluorooctane sulfonates (PFOS) and its derivatives	-	mg/kg	-	ND

Notes :



Unless otherwise agreed in writing, this document is issued by the Company subject to its General Conditions of Service printed overleaf, available on request or accessible at <http://www.sgs.com/en/Terms-and-Conditions.aspx> and, for electronic format documents, subject to Terms and Conditions for Electronic Documents at <http://www.sgs.com/en/Terms-and-Conditions/Terms-e-Documents.aspx>. Attention is drawn to the limitation of liability, indemnification and jurisdiction issues defined therein. Any holder of this document is advised that information contained hereon reflects the Company's findings at the time of its intervention only and within the limits of Client's instructions, if any. The Company's sole responsibility is to its Client and this document does not exonerate parties to a transaction from exercising all their rights and obligations under the transaction documents. This document cannot be reproduced except in full, without prior written approval of the Company. Any unauthorized alteration, forgery or falsification of the content or appearance of this document is unlawful and offenders may be prosecuted to the fullest extent of the law. Unless otherwise stated the results shown in this test report refer only to the sample(s) tested.

Attention: To check the authenticity of testing /inspection report & certificate, please contact us at telephone: (86-755) 8307 1443, or email: CN.Doccheck@sgs.com

- (1) + PFOA and its salts including PFOA-Na (CAS No.: 335-95-5), PFOA-K (CAS No.: 2395-00-8), PFOA-Ag (CAS No.: 335-93-3), PFOA-F (CAS No.: 335-66-0) and APFO (CAS No.: 3825-26-1);
- (2) ^ PFOS including PFOS-K (CAS No.: 2795-39-3), PFOS-Li (CAS No.: 29457-72-5), PFOS-NH₄ (CAS No.: 29081-56-9), PFOS-NH(OH)₂ (CAS No.: 70225-14-8), PFOS-N(C₂H₅)₄ (CAS No.: 56773-42-3), PFOS-DDA (CAS No.: 251099-16-8) and POSF (CAS No.: 307-35-7)

Unless otherwise stated, the decision rule for conformity reporting is based on Binary Statement for Simple Acceptance Rule ($w=0$) stated in ILAC-G8:09/2019.



Unless otherwise agreed in writing, this document is issued by the Company subject to its General Conditions of Service printed overleaf, available on request or accessible at <http://www.sgs.com/en/Terms-and-Conditions.aspx> and, for electronic format documents, subject to Terms and Conditions for Electronic Documents at <http://www.sgs.com/en/Terms-and-Conditions/Terms-e-Documents.aspx>. Attention is drawn to the limitation of liability, indemnification and jurisdiction issues defined therein. Any holder of this document is advised that information contained hereon reflects the Company's findings at the time of its intervention only and within the limits of Client's instructions, if any. The Company's sole responsibility is to its Client and this document does not exonerate parties to a transaction from exercising all their rights and obligations under the transaction documents. This document cannot be reproduced except in full, without prior written approval of the Company. Any unauthorized alteration, forgery or falsification of the content or appearance of this document is unlawful and offenders may be prosecuted to the fullest extent of the law. Unless otherwise stated the results shown in this test report refer only to the sample(s) tested.

Attention: To check the authenticity of testing / inspection report & certificate, please contact us at telephone: (86-755) 8307 1443, or email: CN.Doccheck@sgs.com

ATTACHMENTS

Pb/Cd/Hg/Cr⁶⁺/PBBs/PBDEs Testing Flow Chart

1) These samples were dissolved totally by pre-conditioning method according to below flow chart. (Cr⁶⁺ and PBBs/PBDEs test method excluded).

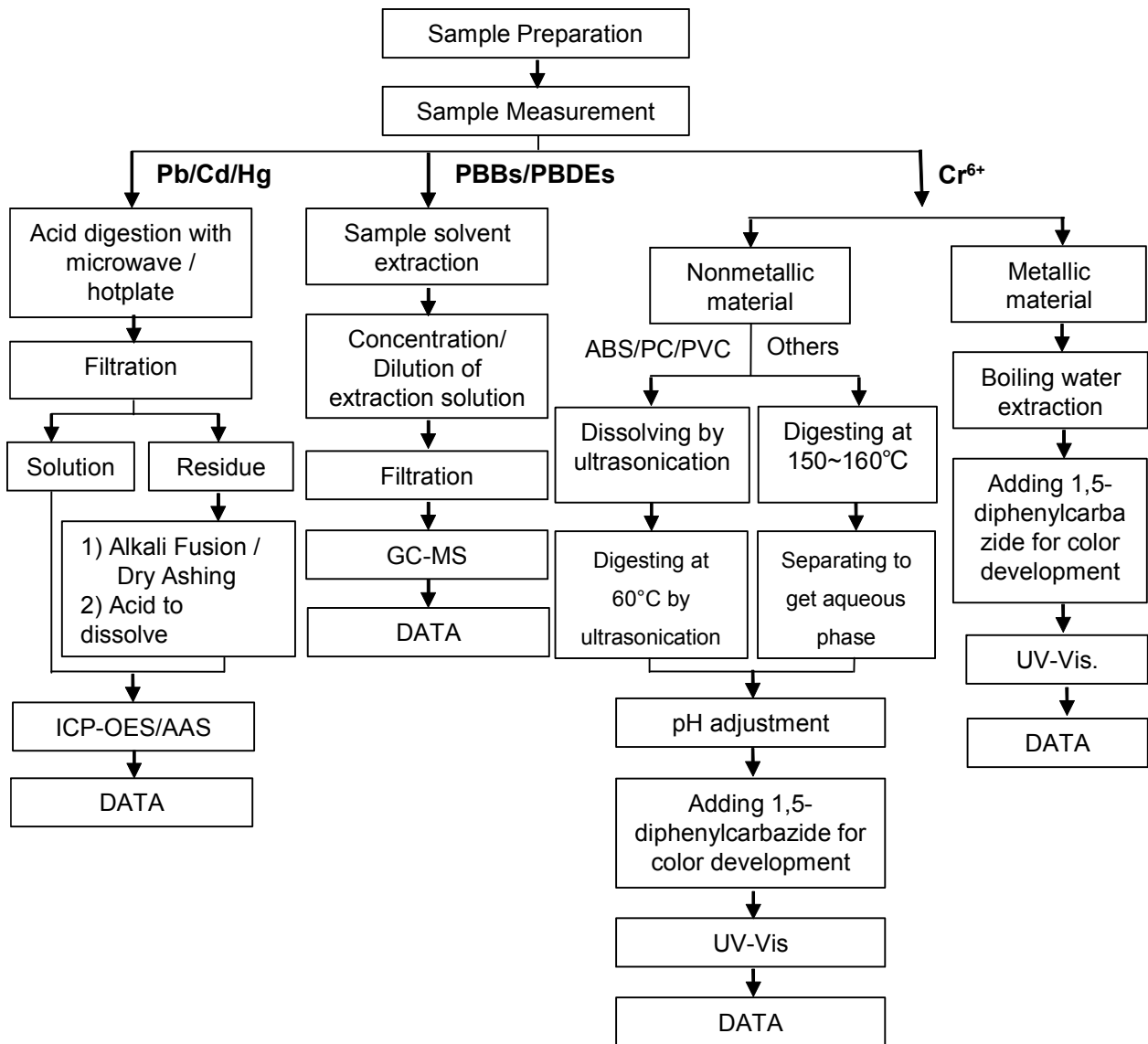

ATTACHMENTS

Phthalates Testing Flow Chart

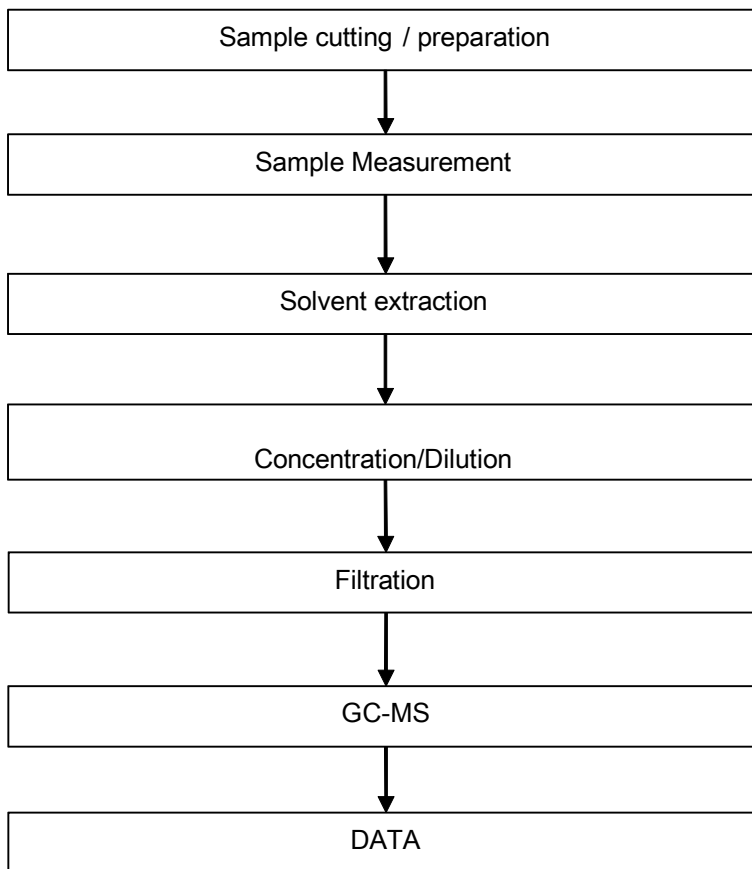

Unless otherwise agreed in writing, this document is issued by the Company subject to its General Conditions of Service printed overleaf, available on request or accessible at <http://www.sgs.com/en/Terms-and-Conditions.aspx> and, for electronic format documents, subject to Terms and Conditions for Electronic Documents at <http://www.sgs.com/en/Terms-and-Conditions/Terms-e-Document.aspx>. Attention is drawn to the limitation of liability, indemnification and jurisdiction issues defined therein. Any holder of this document is advised that information contained hereon reflects the Company's findings at the time of its intervention only and within the limits of Client's instructions, if any. The Company's sole responsibility is to its Client and this document does not exonerate parties to a transaction from exercising all their rights and obligations under the transaction documents. This document cannot be reproduced except in full, without prior written approval of the Company. Any unauthorized alteration, forgery or falsification of the content or appearance of this document is unlawful and offenders may be prosecuted to the fullest extent of the law. Unless otherwise stated the results shown in this test report refer only to the sample(s) tested.

Attention: To check the authenticity of testing / inspection report & certificate, please contact us at telephone: (86-755) 8307 1443, or email: CN_Doccheck@sgs.com

ATTACHMENTS

PFOA / PFOS Testing Flow Chart

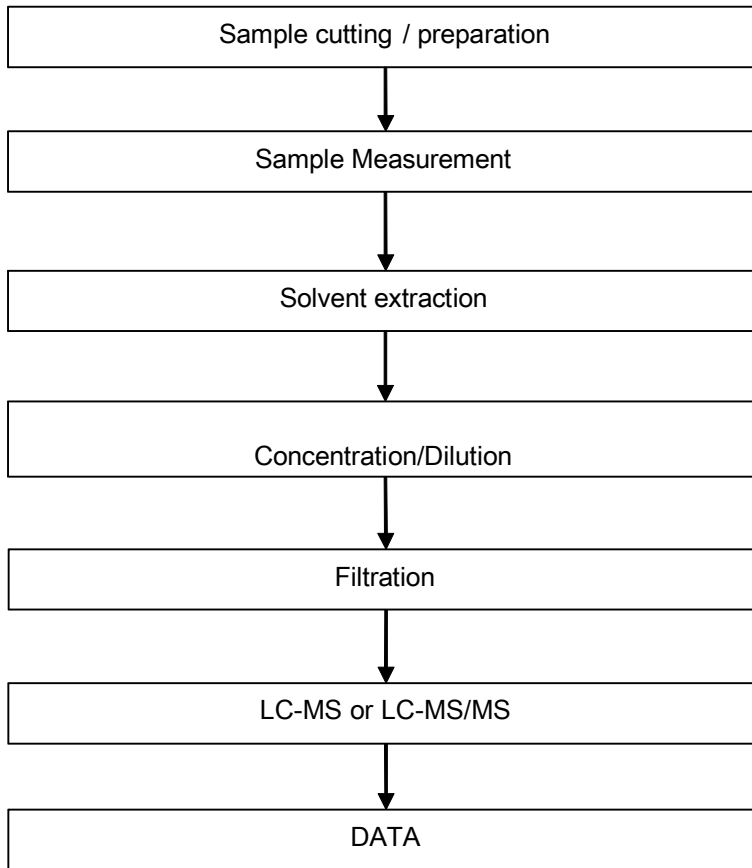

Unless otherwise agreed in writing, this document is issued by the Company subject to its General Conditions of Service printed overleaf, available on request or accessible at <http://www.sgs.com/en/Terms-and-Conditions.aspx> and, for electronic format documents, subject to Terms and Conditions for Electronic Documents at <http://www.sgs.com/en/Terms-and-Conditions/Terms-e-Document.aspx>. Attention is drawn to the limitation of liability, indemnification and jurisdiction issues defined therein. Any holder of this document is advised that information contained hereon reflects the Company's findings at the time of its intervention only and within the limits of Client's instructions, if any. The Company's sole responsibility is to its Client and this document does not exonerate parties to a transaction from exercising all their rights and obligations under the transaction documents. This document cannot be reproduced except in full, without prior written approval of the Company. Any unauthorized alteration, forgery or falsification of the content or appearance of this document is unlawful and offenders may be prosecuted to the fullest extent of the law. Unless otherwise stated the results shown in this test report refer only to the sample(s) tested.

Attention: To check the authenticity of testing / inspection report & certificate, please contact us at telephone: (86-755) 8307 1443, or email: CN_Doccheck@sgs.com

Sample photo:



SGS authenticate the photo on original report only

*** End of Report ***



Test Report

No. CANEC2218227001

Date: 30 Aug 2022

Page 1 of 8

Client Name : SHENZHEN CITY TONGHUA INDUSTRY CO.,LTD

Client Address : TONGHUA MANSIN TONGLE XINBU VILLANG TOWN SHENZHEN CITY CHINA

Sample Name : Nickel(Ni)

The above sample(s) and information were provided by the client.

SGS Job No. : CP22-047169 - SZ
 Date of Sample Received : 25 Aug 2022
 Testing Period : 25 Aug 2022 - 30 Aug 2022
 Test Requested : Selected test(s) as requested by the client.
 Test Method(s) : Please refer to next page(s).
 Test Result(s) : Please refer to next page(s).

Result Summary :

Test Requested	Conclusion
EU RoHS Directive (EU) 2015/863 amending Annex II to Directive 2011/65/EU- Lead, Mercury, Cadmium, Hexavalent chromium, Polybrominated biphenyls (PBBs), Polybrominated diphenyl ethers (PBDEs), Bis(2-ethylhexyl) phthalate (DEHP), Butyl benzyl phthalate (BBP), Dibutyl phthalate (DBP) and Diisobutyl phthalate (DIBP)	PASS
Perfluorooctanoic acid (PFOA) and its salts & Perfluorooctane sulfonates (PFOS) and its derivatives	See Results

Signed for and on behalf of
 SGS-CSTC Standards Technical Services Co., Ltd. Guangzhou Branch

Dongyu Xie

Dongyu Xie
 Approved Signatory

scan to see the report



5753937E



Test Report

No. CANEC2218227001

Date: 30 Aug 2022

Page 2 of 8

Test Result(s) :

Test Part Description :

Specimen No.	SGS Sample ID	Description
SN1	CAN22-182270.001	Silver-gray plated metal

Remarks :

- (1) 1 mg/kg = 0.0001%
- (2) MDL = Method Detection Limit
- (3) ND = Not Detected (< MDL)
- (4) "-" = Not Regulated

EU RoHS Directive (EU) 2015/863 amending Annex II to Directive 2011/65/EU- Lead, Mercury, Cadmium, Hexavalent chromium, Polybrominated biphenyls (PBBs), Polybrominated diphenyl ethers (PBDEs), Bis(2-ethylhexyl) phthalate (DEHP), Butyl benzyl phthalate (BBP), Dibutyl phthalate (DBP) and Diisobutyl phthalate (DIBP)

Test Method : With reference to IEC 62321-4:2013+A1:2017, IEC 62321-5:2013, IEC 62321-7-1:2015 , IEC 62321-6:2015 and IEC 62321-8:2017, analyzed by ICP-OES , UV-Vis and GC-MS .

<u>Test Item(s)</u>	<u>Limit</u>	<u>Unit</u>	<u>MDL</u>	<u>001</u>
Cadmium (Cd)	100	mg/kg	2	ND
Lead (Pb)	1000	mg/kg	2	49
Mercury (Hg)	1000	mg/kg	2	ND
Hexavalent Chromium (Cr(VI))▼	-	µg/cm ²	0.10	ND
Sum of PBBs	1000	mg/kg	-	ND
Monobromobiphenyl	-	mg/kg	5	ND
Dibromobiphenyl	-	mg/kg	5	ND
Tribromobiphenyl	-	mg/kg	5	ND
Tetrabromobiphenyl	-	mg/kg	5	ND
Pentabromobiphenyl	-	mg/kg	5	ND
Hexabromobiphenyl	-	mg/kg	5	ND
Heptabromobiphenyl	-	mg/kg	5	ND
Octabromobiphenyl	-	mg/kg	5	ND
Nonabromobiphenyl	-	mg/kg	5	ND
Decabromobiphenyl	-	mg/kg	5	ND
Sum of PBDEs	1000	mg/kg	-	ND
Monobromodiphenyl ether	-	mg/kg	5	ND
Dibromodiphenyl ether	-	mg/kg	5	ND
Tribromodiphenyl ether	-	mg/kg	5	ND
Tetrabromodiphenyl ether	-	mg/kg	5	ND



Unless otherwise agreed in writing, this document is issued by the Company subject to its General Conditions of Service printed overleaf, available on request or accessible at <http://www.sgs.com/en/Terms-and-Conditions.aspx> and, for electronic format documents, subject to Terms and Conditions for Electronic Documents at <http://www.sgs.com/en/Terms-and-Conditions/Terms-e-Document.aspx>. Attention is drawn to the limitation of liability, indemnification and jurisdiction issues defined therein. Any holder of this document is advised that information contained hereon reflects the Company's findings at the time of its intervention only and within the limits of Client's instructions, if any. The Company's sole responsibility is to its Client and this document does not exonerate parties to a transaction from exercising all their rights and obligations under the transaction documents. This document cannot be reproduced except in full, without prior written approval of the Company. Any unauthorized alteration, forgery or falsification of the content or appearance of this document is unlawful and offenders may be prosecuted to the fullest extent of the law. Unless otherwise stated the results shown in this test report refer only to the sample(s) tested.

Attention: To check the authenticity of testing /inspection report & certificate, please contact us at telephone: (86-755) 8307 1443, or email: CN.Doccheck@sgs.com

Test Report

No. CANEC2218227001

Date: 30 Aug 2022

Page 3 of 8

<u>Test Item(s)</u>	<u>Limit</u>	<u>Unit</u>	<u>MDL</u>	<u>001</u>
Pentabromodiphenyl ether	-	mg/kg	5	ND
Hexabromodiphenyl ether	-	mg/kg	5	ND
Heptabromodiphenyl ether	-	mg/kg	5	ND
Octabromodiphenyl ether	-	mg/kg	5	ND
Nonabromodiphenyl ether	-	mg/kg	5	ND
Decabromodiphenyl ether	-	mg/kg	5	ND
Dibutyl phthalate (DBP)	1000	mg/kg	50	ND
Butyl benzyl phthalate (BBP)	1000	mg/kg	50	ND
Bis (2-ethylhexyl) phthalate (DEHP)	1000	mg/kg	50	ND
Diisobutyl Phthalates (DIBP)	1000	mg/kg	50	ND

Notes :

- (1) The maximum permissible limit is quoted from RoHS Directive (EU) 2015/863.
- (2) IEC 62321 series is equivalent to EN 62321 series
- (3) ▼= a. The sample is positive for CrVI if the CrVI concentration is greater than 0.13 µg/cm². The sample coating is considered to contain CrVI
 b. The sample is negative for CrVI if CrVI is ND (concentration less than 0.10 µg/cm²). The coating is considered a non-CrVI based coating
 c. The result between 0.10 µg/cm² and 0.13 µg/cm² is considered to be inconclusive - unavoidable coating variations may influence the determination
 Information on storage conditions and production date of the tested sample is unavailable and thus Cr(VI) results represent status of the sample at the time of testing.

Perfluorooctanoic acid (PFOA) and its salts & Perfluorooctane sulfonates (PFOS) and its derivatives

Test Method : With reference to CEN/TS15968:2010, analysis was performed by LC-MS or LC-MS/MS.

<u>Test Item(s)</u>	<u>CAS NO.</u>	<u>Unit</u>	<u>MDL</u>	<u>001</u>
Perfluorooctanoic acid (PFOA) and its salts+	335-67-1	mg/kg	0.010	ND
Perfluorooctane sulfonates (PFOS) ^	1763-23-1	mg/kg	0.010	ND
Perfluorooctane Sulfonamide (PFOSA)	754-91-6	mg/kg	0.010	ND
N-methylperfluoro-1-octanesulfonamide(MeFOSA)	31506-32-8	mg/kg	0.010	ND
N-ethylperfluoro-1-octanesulfonamide (EtFOSA)	4151-50-2	mg/kg	0.010	ND
2-(N-methylperfluoro-1-octanesulfonamido)-ethanol(MeFOSE)	24448-09-7	mg/kg	0.010	ND
2-(N-ethylperfluoro-1-octanesulfonamido)-ethanol(EtFOSE)	1691-99-2	mg/kg	0.010	ND
Perfluorooctane sulfonates (PFOS) and its derivatives	-	mg/kg	-	ND

Notes :



Unless otherwise agreed in writing, this document is issued by the Company subject to its General Conditions of Service printed overleaf, available on request or accessible at <http://www.sgs.com/en/Terms-and-Conditions.aspx> and, for electronic format documents, subject to Terms and Conditions for Electronic Documents at <http://www.sgs.com/en/Terms-and-Conditions/Terms-e-Documents.aspx>. Attention is drawn to the limitation of liability, indemnification and jurisdiction issues defined therein. Any holder of this document is advised that information contained hereon reflects the Company's findings at the time of its intervention only and within the limits of Client's instructions, if any. The Company's sole responsibility is to its Client and this document does not exonerate parties to a transaction from exercising all their rights and obligations under the transaction documents. This document cannot be reproduced except in full, without prior written approval of the Company. Any unauthorized alteration, forgery or falsification of the content or appearance of this document is unlawful and offenders may be prosecuted to the fullest extent of the law. Unless otherwise stated the results shown in this test report refer only to the sample(s) tested.

Attention: To check the authenticity of testing /inspection report & certificate, please contact us at telephone: (86-755) 8307 1443, or email: CN.Doccheck@sgs.com

- (1) + PFOA and its salts including PFOA-Na (CAS No.: 335-95-5), PFOA-K (CAS No.: 2395-00-8), PFOA-Ag (CAS No.: 335-93-3), PFOA-F (CAS No.: 335-66-0) and APFO (CAS No.: 3825-26-1);
- (2) ^ PFOS including PFOS-K (CAS No.: 2795-39-3), PFOS-Li (CAS No.: 29457-72-5), PFOS-NH₄ (CAS No.: 29081-56-9), PFOS-NH(OH)₂ (CAS No.: 70225-14-8), PFOS-N(C₂H₅)₄ (CAS No.: 56773-42-3), PFOS-DDA (CAS No.: 251099-16-8) and POSF (CAS No.: 307-35-7)

Unless otherwise stated, the decision rule for conformity reporting is based on Binary Statement for Simple Acceptance Rule ($w=0$) stated in ILAC-G8:09/2019.



Unless otherwise agreed in writing, this document is issued by the Company subject to its General Conditions of Service printed overleaf, available on request or accessible at <http://www.sgs.com/en/Terms-and-Conditions.aspx> and, for electronic format documents, subject to Terms and Conditions for Electronic Documents at <http://www.sgs.com/en/Terms-and-Conditions/Terms-e-Documents.aspx>. Attention is drawn to the limitation of liability, indemnification and jurisdiction issues defined therein. Any holder of this document is advised that information contained hereon reflects the Company's findings at the time of its intervention only and within the limits of Client's instructions, if any. The Company's sole responsibility is to its Client and this document does not exonerate parties to a transaction from exercising all their rights and obligations under the transaction documents. This document cannot be reproduced except in full, without prior written approval of the Company. Any unauthorized alteration, forgery or falsification of the content or appearance of this document is unlawful and offenders may be prosecuted to the fullest extent of the law. Unless otherwise stated the results shown in this test report refer only to the sample(s) tested.

Attention: To check the authenticity of testing / inspection report & certificate, please contact us at telephone: (86-755) 8307 1443, or email: CN.Doccheck@sgs.com

ATTACHMENTS

Pb/Cd/Hg/Cr⁶⁺/PBBs/PBDEs Testing Flow Chart

1) These samples were dissolved totally by pre-conditioning method according to below flow chart. (Cr⁶⁺ and PBBs/PBDEs test method excluded).

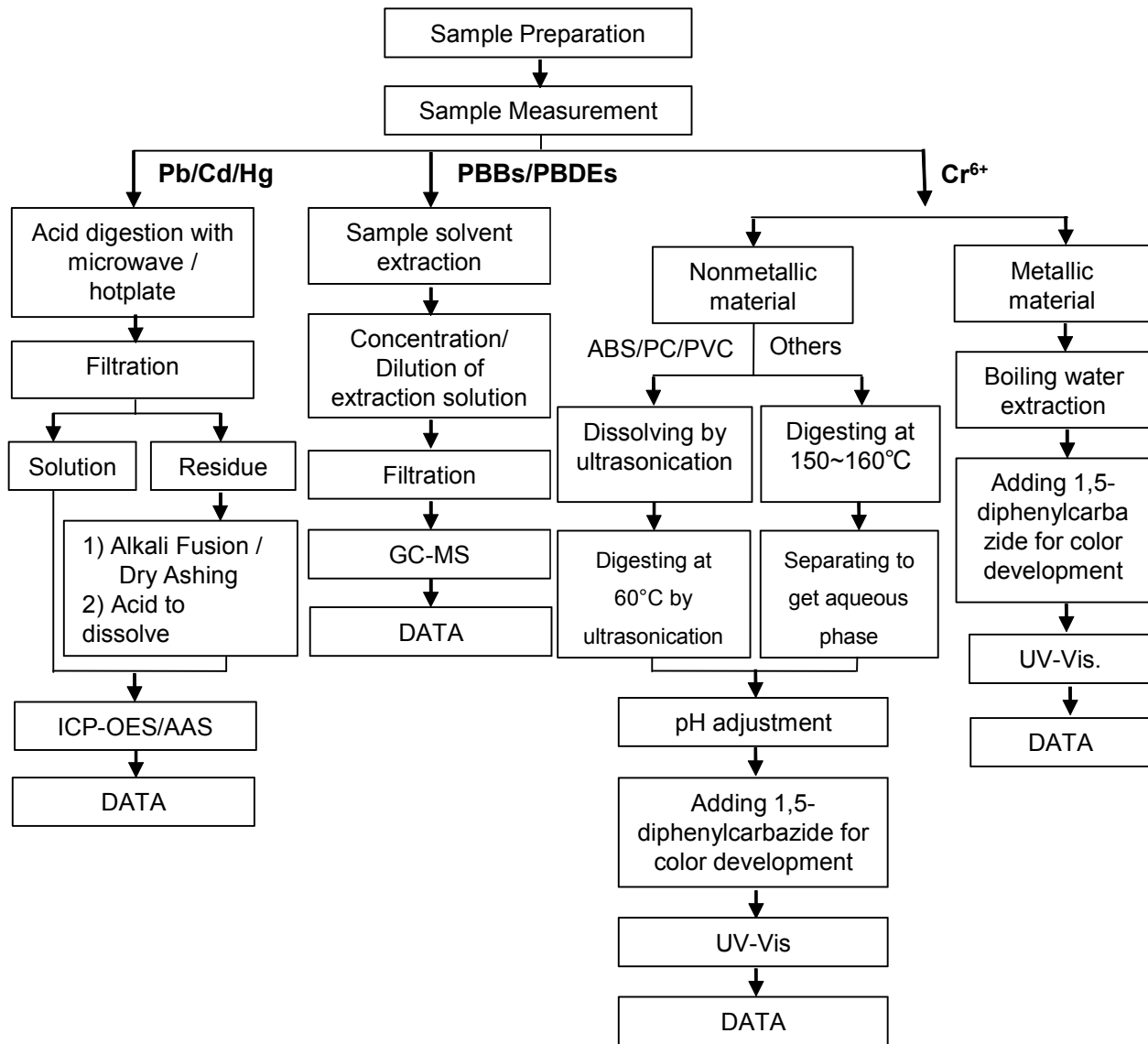

ATTACHMENTS

Phthalates Testing Flow Chart

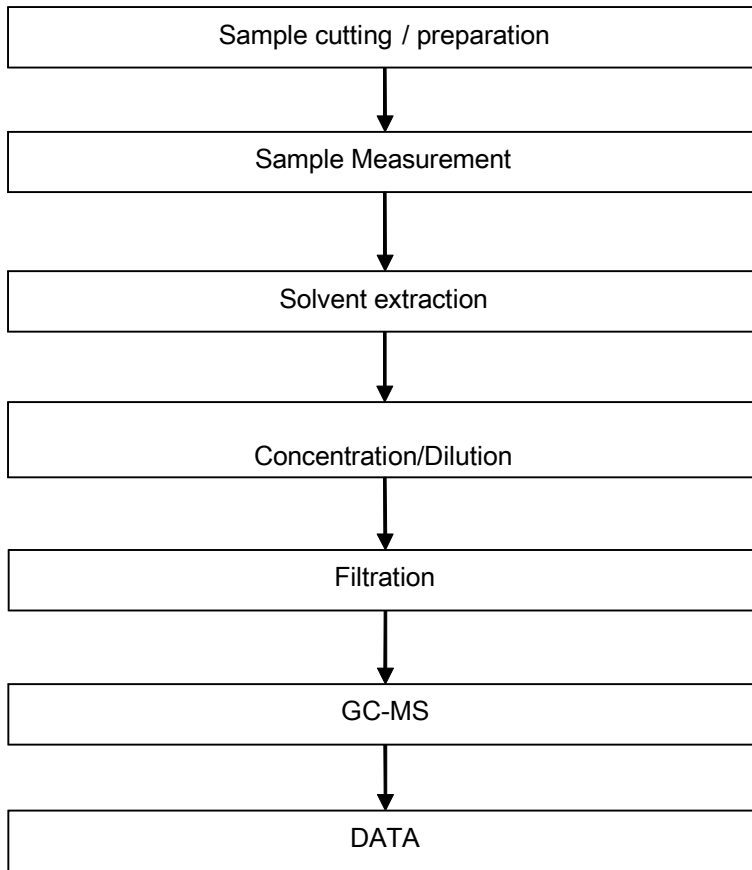

Unless otherwise agreed in writing, this document is issued by the Company subject to its General Conditions of Service printed overleaf, available on request or accessible at <http://www.sgs.com/en/Terms-and-Conditions.aspx> and, for electronic format documents, subject to Terms and Conditions for Electronic Documents at <http://www.sgs.com/en/Terms-and-Conditions/Terms-e-Document.aspx>. Attention is drawn to the limitation of liability, indemnification and jurisdiction issues defined therein. Any holder of this document is advised that information contained hereon reflects the Company's findings at the time of its intervention only and within the limits of Client's instructions, if any. The Company's sole responsibility is to its Client and this document does not exonerate parties to a transaction from exercising all their rights and obligations under the transaction documents. This document cannot be reproduced except in full, without prior written approval of the Company. Any unauthorized alteration, forgery or falsification of the content or appearance of this document is unlawful and offenders may be prosecuted to the fullest extent of the law. Unless otherwise stated the results shown in this test report refer only to the sample(s) tested.

Attention: To check the authenticity of testing / inspection report & certificate, please contact us at telephone: (86-755) 8307 1443, or email: CN_Doccheck@sgs.com

ATTACHMENTS

PFOA / PFOS Testing Flow Chart

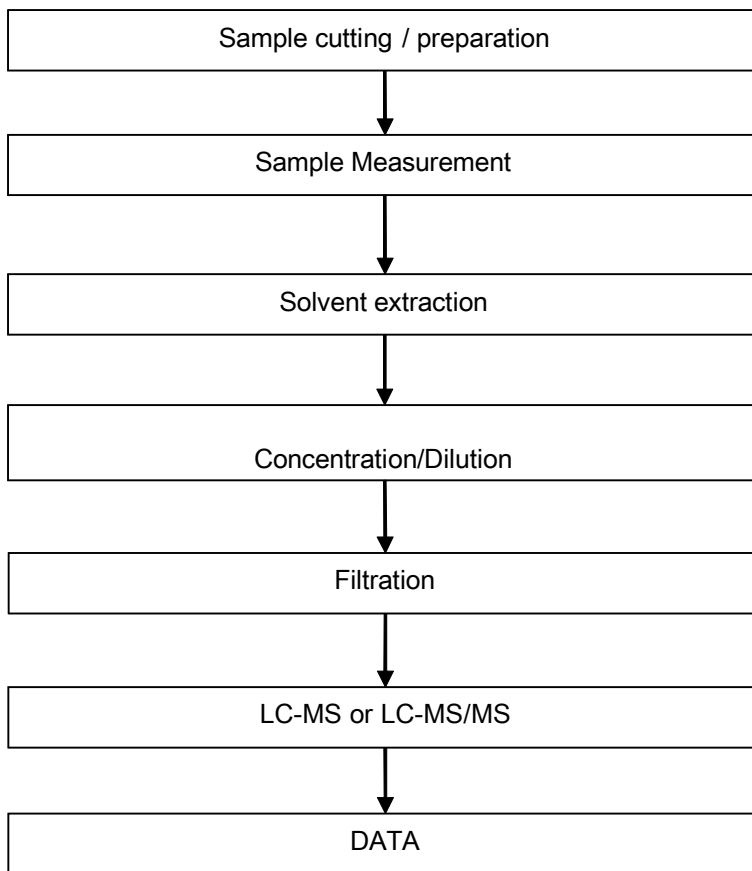

Unless otherwise agreed in writing, this document is issued by the Company subject to its General Conditions of Service printed overleaf, available on request or accessible at <http://www.sgs.com/en/Terms-and-Conditions.aspx> and, for electronic format documents, subject to Terms and Conditions for Electronic Documents at <http://www.sgs.com/en/Terms-and-Conditions/Terms-e-Document.aspx>. Attention is drawn to the limitation of liability, indemnification and jurisdiction issues defined therein. Any holder of this document is advised that information contained hereon reflects the Company's findings at the time of its intervention only and within the limits of Client's instructions, if any. The Company's sole responsibility is to its Client and this document does not exonerate parties to a transaction from exercising all their rights and obligations under the transaction documents. This document cannot be reproduced except in full, without prior written approval of the Company. Any unauthorized alteration, forgery or falsification of the content or appearance of this document is unlawful and offenders may be prosecuted to the fullest extent of the law. Unless otherwise stated the results shown in this test report refer only to the sample(s) tested.

Attention: To check the authenticity of testing / inspection report & certificate, please contact us at telephone: (86-755) 8307 1443, or email: CN.Doccheck@sgs.com

Sample photo:



SGS authenticate the photo on original report only

*** End of Report ***



Test Report

No. CANEC2218227003

Date: 30 Aug 2022

Page 1 of 8

Client Name : SHENZHEN CITY TONGHUA INDUSTRY CO.,LTD

Client Address : TONGHUA MANSIN TONGLE XINBU VILLANG TOWN SHENZHEN CITY CHINA

Sample Name : Bright Tin(SN)

The above sample(s) and information were provided by the client.

SGS Job No. : CP22-047169 - SZ
 Date of Sample Received : 25 Aug 2022
 Testing Period : 25 Aug 2022 - 30 Aug 2022
 Test Requested : Selected test(s) as requested by the client.
 Test Method(s) : Please refer to next page(s).
 Test Result(s) : Please refer to next page(s).

Result Summary :

Test Requested	Conclusion
EU RoHS Directive (EU) 2015/863 amending Annex II to Directive 2011/65/EU- Lead, Mercury, Cadmium, Hexavalent chromium, Polybrominated biphenyls (PBBs), Polybrominated diphenyl ethers (PBDEs), Bis(2-ethylhexyl) phthalate (DEHP), Butyl benzyl phthalate (BBP), Dibutyl phthalate (DBP) and Diisobutyl phthalate (DIBP)	PASS
Perfluorooctanoic acid (PFOA) and its salts & Perfluorooctane sulfonates (PFOS) and its derivatives	See Results

Signed for and on behalf of
 SGS-CSTC Standards Technical Services Co., Ltd. Guangzhou Branch

Dongyu Xie

Dongyu Xie
 Approved Signatory

scan to see the report



87F8007D



Unless otherwise agreed in writing, this document is issued by the Company subject to its General Conditions of Service printed overleaf, available on request or accessible at <http://www.sgs.com/en/Terms-and-Conditions.aspx> and, for electronic format documents, subject to Terms and Conditions for Electronic Documents at <http://www.sgs.com/en/Terms-and-Conditions/Terms-e-Document.aspx>. Attention is drawn to the limitation of liability, indemnification and jurisdiction issues defined therein. Any holder of this document is advised that information contained hereon reflects the Company's findings at the time of its intervention only and within the limits of Client's instructions, if any. The Company's sole responsibility is to its Client and this document does not exonerate parties to a transaction from exercising all their rights and obligations under the transaction documents. This document cannot be reproduced except in full, without prior written approval of the Company. Any unauthorized alteration, forgery or falsification of the content or appearance of this document is unlawful and offenders may be prosecuted to the fullest extent of the law. Unless otherwise stated the results shown in this test report refer only to the sample(s) tested.

Attention: To check the authenticity of testing /inspection report & certificate, please contact us at telephone: (86-755) 8307 1443, or email: CN.Doccheck@sgs.com

Test Report

No. CANEC2218227003

Date: 30 Aug 2022

Page 2 of 8

Test Result(s) :

Test Part Description :

Specimen No.	SGS Sample ID	Description
SN1	CAN22-182270.003	Silver-gray plated metal

Remarks :

- (1) 1 mg/kg = 0.0001%
- (2) MDL = Method Detection Limit
- (3) ND = Not Detected (< MDL)
- (4) "-" = Not Regulated

EU RoHS Directive (EU) 2015/863 amending Annex II to Directive 2011/65/EU- Lead, Mercury, Cadmium, Hexavalent chromium, Polybrominated biphenyls (PBBs), Polybrominated diphenyl ethers (PBDEs), Bis(2-ethylhexyl) phthalate (DEHP), Butyl benzyl phthalate (BBP), Dibutyl phthalate (DBP) and Diisobutyl phthalate (DIBP)

Test Method : With reference to IEC 62321-4:2013+A1:2017, IEC 62321-5:2013, IEC 62321-7-1:2015 , IEC 62321-6:2015 and IEC 62321-8:2017, analyzed by ICP-OES , UV-Vis and GC-MS .

Test Item(s)	Limit	Unit	MDL	003
Cadmium (Cd)	100	mg/kg	2	ND
Lead (Pb)	1000	mg/kg	2	44
Mercury (Hg)	1000	mg/kg	2	ND
Hexavalent Chromium (Cr(VI))▼	-	µg/cm ²	0.10	ND
Sum of PBBs	1000	mg/kg	-	ND
Monobromobiphenyl	-	mg/kg	5	ND
Dibromobiphenyl	-	mg/kg	5	ND
Tribromobiphenyl	-	mg/kg	5	ND
Tetrabromobiphenyl	-	mg/kg	5	ND
Pentabromobiphenyl	-	mg/kg	5	ND
Hexabromobiphenyl	-	mg/kg	5	ND
Heptabromobiphenyl	-	mg/kg	5	ND
Octabromobiphenyl	-	mg/kg	5	ND
Nonabromobiphenyl	-	mg/kg	5	ND
Decabromobiphenyl	-	mg/kg	5	ND
Sum of PBDEs	1000	mg/kg	-	ND
Monobromodiphenyl ether	-	mg/kg	5	ND
Dibromodiphenyl ether	-	mg/kg	5	ND
Tribromodiphenyl ether	-	mg/kg	5	ND
Tetrabromodiphenyl ether	-	mg/kg	5	ND



Unless otherwise agreed in writing, this document is issued by the Company subject to its General Conditions of Service printed overleaf, available on request or accessible at <http://www.sgs.com/en/Terms-and-Conditions.aspx> and, for electronic format documents, subject to Terms and Conditions for Electronic Documents at <http://www.sgs.com/en/Terms-and-Conditions/Terms-e-Documents.aspx>. Attention is drawn to the limitation of liability, indemnification and jurisdiction issues defined therein. Any holder of this document is advised that information contained hereon reflects the Company's findings at the time of its intervention only and within the limits of Client's instructions, if any. The Company's sole responsibility is to its Client and this document does not exonerate parties to a transaction from exercising all their rights and obligations under the transaction documents. This document cannot be reproduced except in full, without prior written approval of the Company. Any unauthorized alteration, forgery or falsification of the content or appearance of this document is unlawful and offenders may be prosecuted to the fullest extent of the law. Unless otherwise stated the results shown in this test report refer only to the sample(s) tested.

Attention: To check the authenticity of testing / inspection report & certificate, please contact us at telephone: (86-755) 8307 1443, or email: CN.Doccheck@sgs.com

Test Report

No. CANEC2218227003

Date: 30 Aug 2022

Page 3 of 8

<u>Test Item(s)</u>	<u>Limit</u>	<u>Unit</u>	<u>MDL</u>	<u>003</u>
Pentabromodiphenyl ether	-	mg/kg	5	ND
Hexabromodiphenyl ether	-	mg/kg	5	ND
Heptabromodiphenyl ether	-	mg/kg	5	ND
Octabromodiphenyl ether	-	mg/kg	5	ND
Nonabromodiphenyl ether	-	mg/kg	5	ND
Decabromodiphenyl ether	-	mg/kg	5	ND
Dibutyl phthalate (DBP)	1000	mg/kg	50	ND
Butyl benzyl phthalate (BBP)	1000	mg/kg	50	ND
Bis (2-ethylhexyl) phthalate (DEHP)	1000	mg/kg	50	ND
Diisobutyl Phthalates (DIBP)	1000	mg/kg	50	ND

Notes :

- (1) The maximum permissible limit is quoted from RoHS Directive (EU) 2015/863.
 - (2) IEC 62321 series is equivalent to EN 62321 series
 - (3) ▼= a. The sample is positive for CrVI if the CrVI concentration is greater than 0.13 µg/cm². The sample coating is considered to contain CrVI
 b. The sample is negative for CrVI if CrVI is ND (concentration less than 0.10 µg/cm²). The coating is considered a non-CrVI based coating
 c. The result between 0.10 µg/cm² and 0.13 µg/cm² is considered to be inconclusive - unavoidable coating variations may influence the determination
- Information on storage conditions and production date of the tested sample is unavailable and thus Cr(VI) results represent status of the sample at the time of testing.

Perfluorooctanoic acid (PFOA) and its salts & Perfluorooctane sulfonates (PFOS) and its derivatives

Test Method : With reference to CEN/TS15968:2010, analysis was performed by LC-MS or LC-MS/MS.

<u>Test Item(s)</u>	<u>CAS NO.</u>	<u>Unit</u>	<u>MDL</u>	<u>003</u>
Perfluorooctanoic acid (PFOA) and its salts+	335-67-1	mg/kg	0.010	ND
Perfluorooctane sulfonates (PFOS) ^	1763-23-1	mg/kg	0.010	ND
Perfluorooctane Sulfonamide (PFOSA)	754-91-6	mg/kg	0.010	ND
N-methylperfluoro-1-octanesulfonamide(MeFOSA)	31506-32-8	mg/kg	0.010	ND
N-ethylperfluoro-1-octanesulfonamide (EtFOSA)	4151-50-2	mg/kg	0.010	ND
2-(N-methylperfluoro-1-octanesulfonamido)-ethanol(MeFOSE)	24448-09-7	mg/kg	0.010	ND
2-(N-ethylperfluoro-1-octanesulfonamido)-ethanol(EtFOSE)	1691-99-2	mg/kg	0.010	ND
Perfluorooctane sulfonates (PFOS) and its derivatives	-	mg/kg	-	ND

Notes :



Unless otherwise agreed in writing, this document is issued by the Company subject to its General Conditions of Service printed overleaf, available on request or accessible at <http://www.sgs.com/en/Terms-and-Conditions.aspx> and, for electronic format documents, subject to Terms and Conditions for Electronic Documents at <http://www.sgs.com/en/Terms-and-Conditions/Terms-e-Documents.aspx>. Attention is drawn to the limitation of liability, indemnification and jurisdiction issues defined therein. Any holder of this document is advised that information contained hereon reflects the Company's findings at the time of its intervention only and within the limits of Client's instructions, if any. The Company's sole responsibility is to its Client and this document does not exonerate parties to a transaction from exercising all their rights and obligations under the transaction documents. This document cannot be reproduced except in full, without prior written approval of the Company. Any unauthorized alteration, forgery or falsification of the content or appearance of this document is unlawful and offenders may be prosecuted to the fullest extent of the law. Unless otherwise stated the results shown in this test report refer only to the sample(s) tested.

- (1) + PFOA and its salts including PFOA-Na (CAS No.: 335-95-5), PFOA-K (CAS No.: 2395-00-8), PFOA-Ag (CAS No.: 335-93-3), PFOA-F (CAS No.: 335-66-0) and APFO (CAS No.: 3825-26-1);
- (2) ^ PFOS including PFOS-K (CAS No.: 2795-39-3), PFOS-Li (CAS No.: 29457-72-5), PFOS-NH₄ (CAS No.: 29081-56-9), PFOS-NH(OH)₂ (CAS No.: 70225-14-8), PFOS-N(C₂H₅)₄ (CAS No.: 56773-42-3), PFOS-DDA (CAS No.: 251099-16-8) and POSF (CAS No.: 307-35-7)

Unless otherwise stated, the decision rule for conformity reporting is based on Binary Statement for Simple Acceptance Rule ($w=0$) stated in ILAC-G8:09/2019.



Unless otherwise agreed in writing, this document is issued by the Company subject to its General Conditions of Service printed overleaf, available on request or accessible at <http://www.sgs.com/en/Terms-and-Conditions.aspx> and, for electronic format documents, subject to Terms and Conditions for Electronic Documents at <http://www.sgs.com/en/Terms-and-Conditions/Terms-e-Documents.aspx>. Attention is drawn to the limitation of liability, indemnification and jurisdiction issues defined therein. Any holder of this document is advised that information contained hereon reflects the Company's findings at the time of its intervention only and within the limits of Client's instructions, if any. The Company's sole responsibility is to its Client and this document does not exonerate parties to a transaction from exercising all their rights and obligations under the transaction documents. This document cannot be reproduced except in full, without prior written approval of the Company. Any unauthorized alteration, forgery or falsification of the content or appearance of this document is unlawful and offenders may be prosecuted to the fullest extent of the law. Unless otherwise stated the results shown in this test report refer only to the sample(s) tested.

Attention: To check the authenticity of testing / inspection report & certificate, please contact us at telephone: (86-755) 8307 1443, or email: CN.Doccheck@sgs.com

ATTACHMENTS

Pb/Cd/Hg/Cr⁶⁺/PBBs/PBDEs Testing Flow Chart

1) These samples were dissolved totally by pre-conditioning method according to below flow chart. (Cr⁶⁺ and PBBs/PBDEs test method excluded).

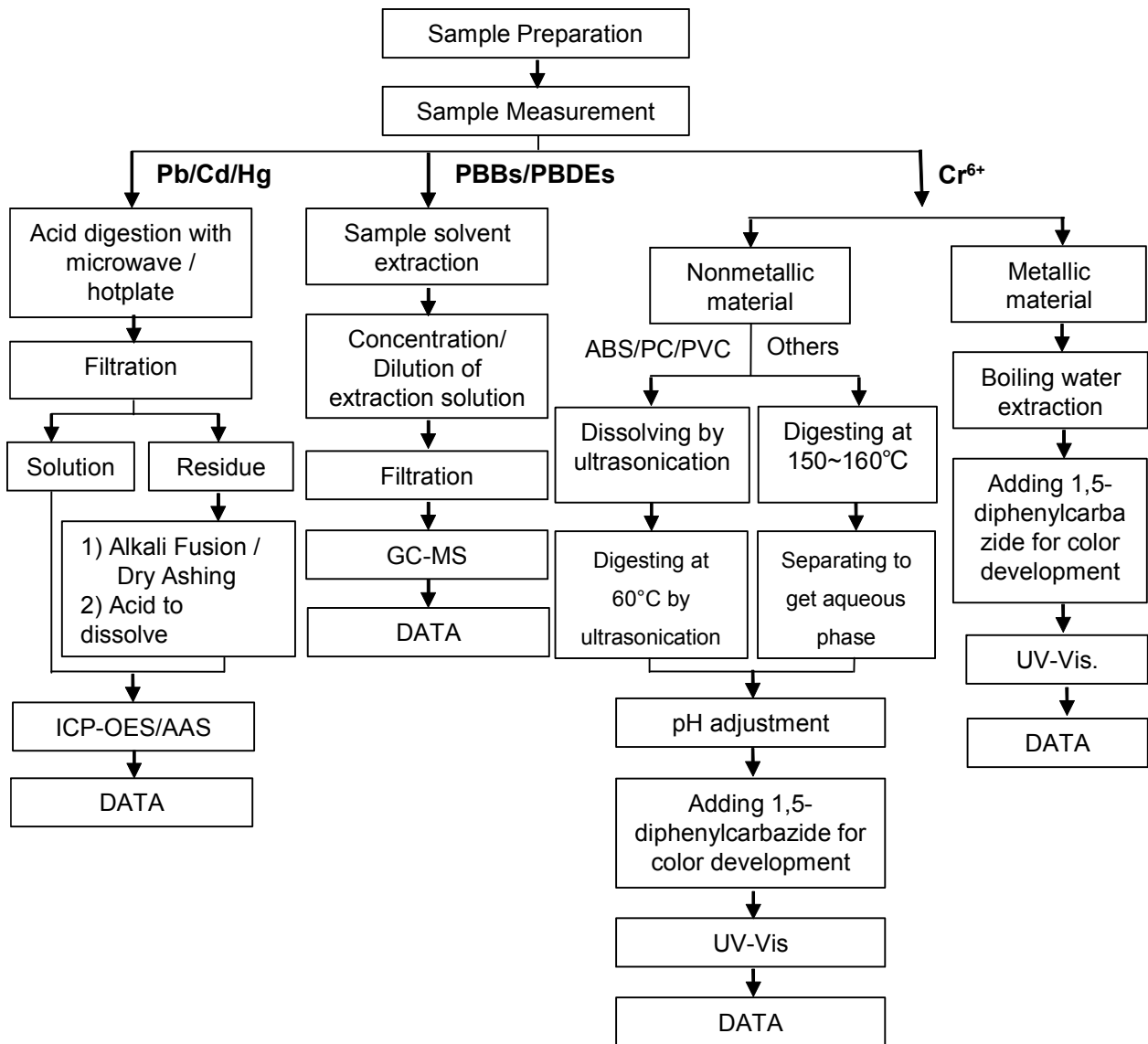

ATTACHMENTS

Phthalates Testing Flow Chart

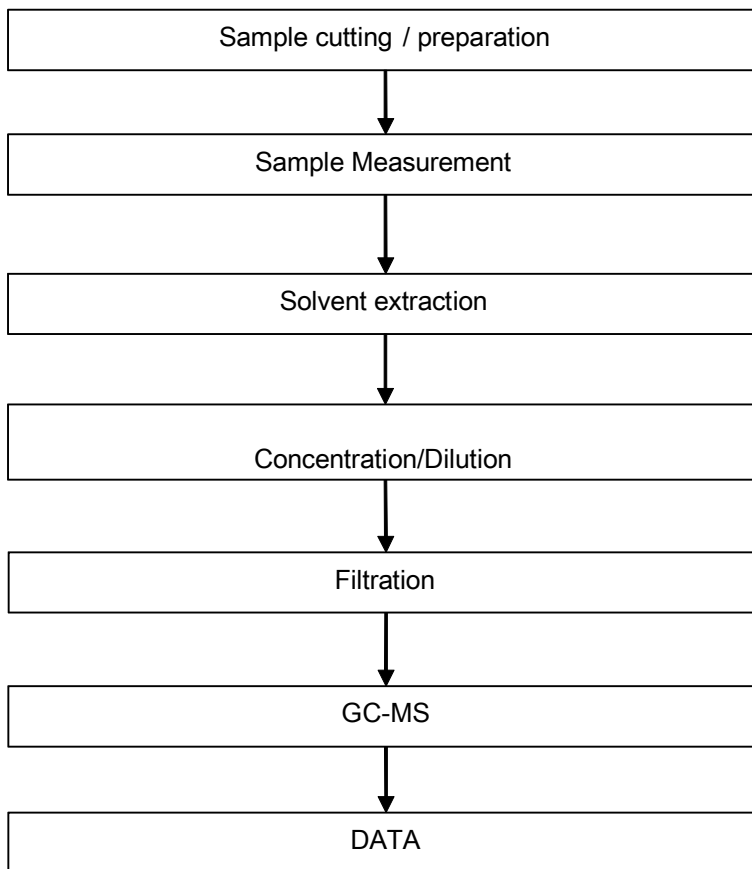

Unless otherwise agreed in writing, this document is issued by the Company subject to its General Conditions of Service printed overleaf, available on request or accessible at <http://www.sgs.com/en/Terms-and-Conditions.aspx> and, for electronic format documents, subject to Terms and Conditions for Electronic Documents at <http://www.sgs.com/en/Terms-and-Conditions/Terms-e-Document.aspx>. Attention is drawn to the limitation of liability, indemnification and jurisdiction issues defined therein. Any holder of this document is advised that information contained hereon reflects the Company's findings at the time of its intervention only and within the limits of Client's instructions, if any. The Company's sole responsibility is to its Client and this document does not exonerate parties to a transaction from exercising all their rights and obligations under the transaction documents. This document cannot be reproduced except in full, without prior written approval of the Company. Any unauthorized alteration, forgery or falsification of the content or appearance of this document is unlawful and offenders may be prosecuted to the fullest extent of the law. Unless otherwise stated the results shown in this test report refer only to the sample(s) tested.

Attention: To check the authenticity of testing / inspection report & certificate, please contact us at telephone: (86-755) 8307 1443, or email: CN_Doccheck@sgs.com

ATTACHMENTS

PFOA / PFOS Testing Flow Chart

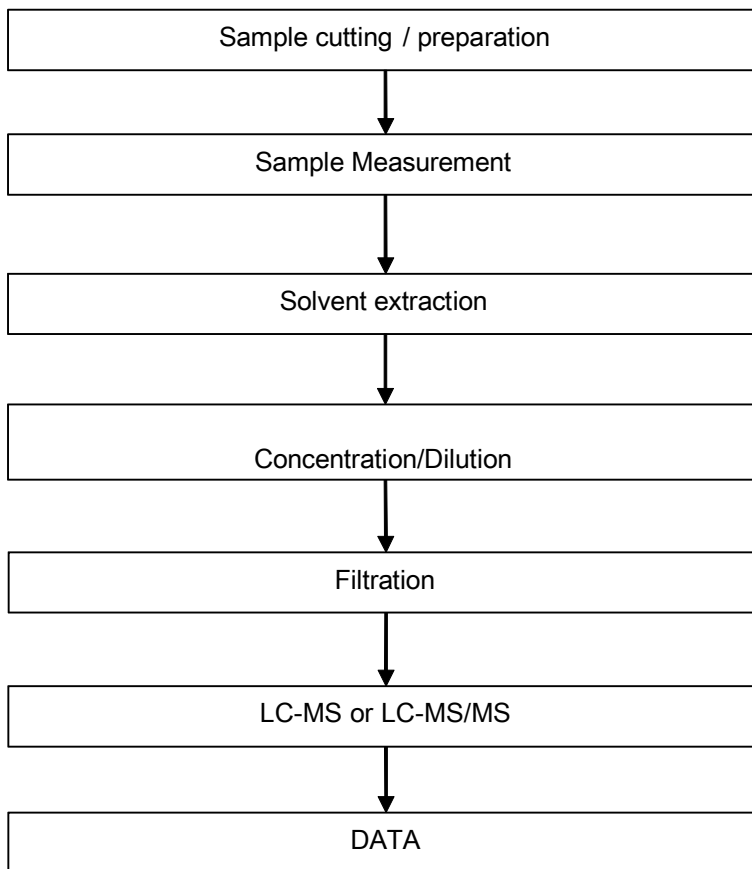

Unless otherwise agreed in writing, this document is issued by the Company subject to its General Conditions of Service printed overleaf, available on request or accessible at <http://www.sgs.com/en/Terms-and-Conditions.aspx> and, for electronic format documents, subject to Terms and Conditions for Electronic Documents at <http://www.sgs.com/en/Terms-and-Conditions/Terms-e-Document.aspx>. Attention is drawn to the limitation of liability, indemnification and jurisdiction issues defined therein. Any holder of this document is advised that information contained hereon reflects the Company's findings at the time of its intervention only and within the limits of Client's instructions, if any. The Company's sole responsibility is to its Client and this document does not exonerate parties to a transaction from exercising all their rights and obligations under the transaction documents. This document cannot be reproduced except in full, without prior written approval of the Company. Any unauthorized alteration, forgery or falsification of the content or appearance of this document is unlawful and offenders may be prosecuted to the fullest extent of the law. Unless otherwise stated the results shown in this test report refer only to the sample(s) tested.

Attention: To check the authenticity of testing / inspection report & certificate, please contact us at telephone: (86-755) 8307 1443, or email: CN.Doccheck@sgs.com

Sample photo:



SGS authenticate the photo on original report only

*** End of Report ***

