

REV.	ECN.NO.	APPD.
A	/	ZFY

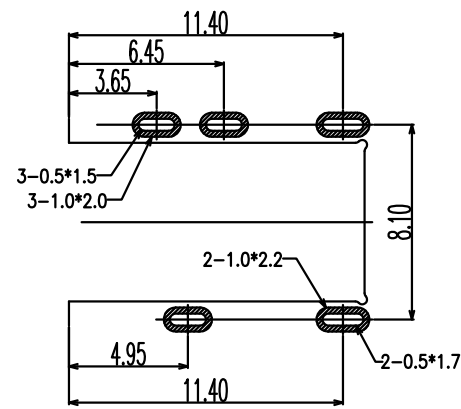
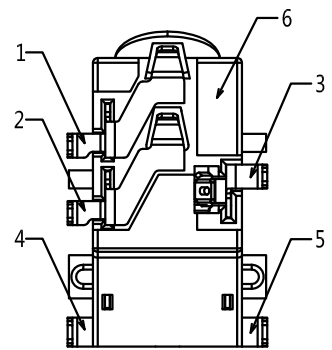
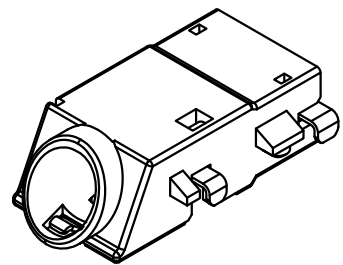

P.C.B LAYOUT
TOP VIEW

- 1.CURRENT RATING : 1.0 AMP. MAX.
- 2.DIELECTRIC WITHSTANDING : AC 500V/min R.M.S.
- 3.INSULATION RESISTANCE : 100MΩ min. AT 100V DC.
- 4.CONTACT RESISTANCE : 50mΩ MAX.
- 5.OPERATING TEMPERATURE : -25°C TO +85°C.
- 6.DURABILITY : 1500 CYCLES.
- 7.MATING FORCE : 3kgs MAX
- 8.UNMATING FORCE :0.3~3.0kgs
- 9.MAX PROCESSING TEMPERATURE :
60 SECONDS IN 230°C AND 10 SECONDS IN 260°C

JK1-167-G318
G: 镀半金G/Fu
1: 黑色
3: PPA

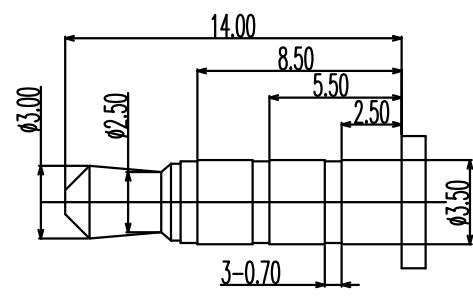
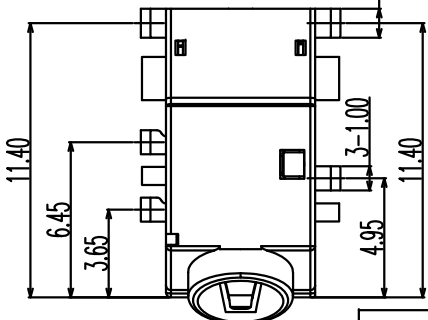
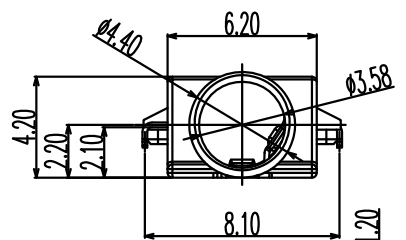
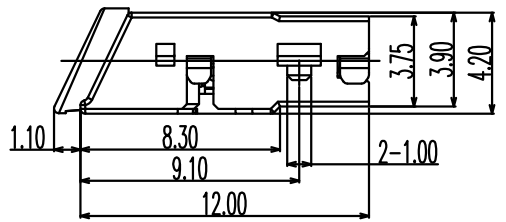

(ø3.50mm 4 POLE PLUG DETAIL DRAWING)

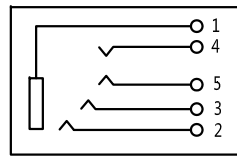

SCHEMATIC

TOLERANCE UNLESS OTHERWISE SPECIFIED		FLW 深圳市华联威电子科技有限公司			
.XXX ±0.15 .XX ±0.20 .X ±0.30		.X' ±5° .XX' ±2°		HUA LIAN WEI TECHNOLOGY ELECTRONICS CO;LTD.	
APPROVED		PART NAME:	ø3.5mm PHONE JACK H=4.2 mm 耳机座板下1.5正斜口5PIN		
CHECKED		PART No:	JK1-167-G318	C	
DRAWN	ZhangFenYan	PROJECTION:	UNIT:	SCALE	SHEET
DATE	2018.10.10		mm	1:1	10F1
					REV. A