

REV.	ECN.NO.	APPD.
A	/	/

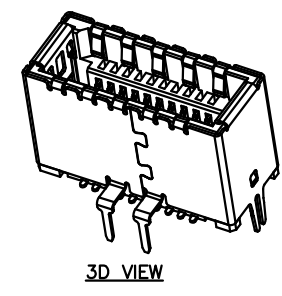
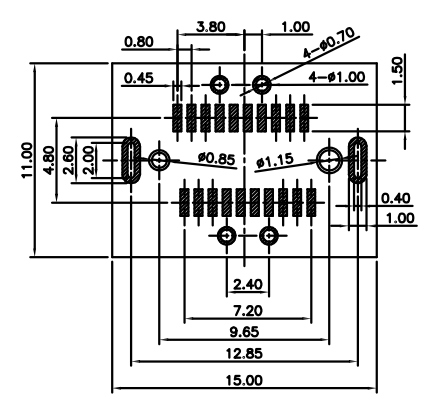
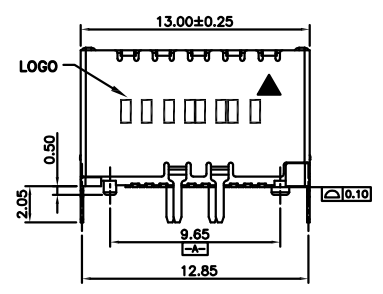
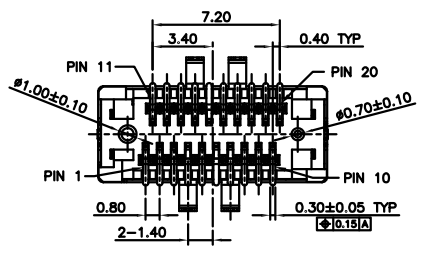
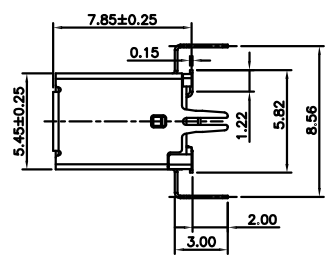
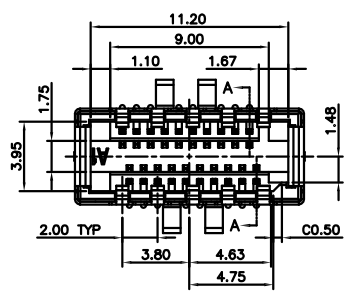
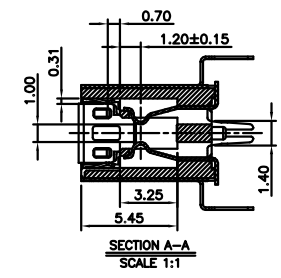
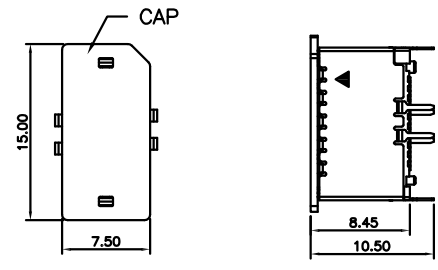
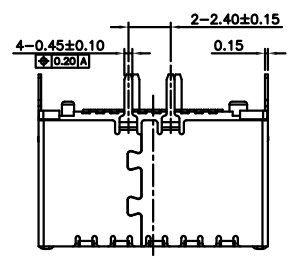

NOTES:  
1.MATERIAL:

- 1.1 Housing:thermoplastic plastics
- 1.2 terminals:Copper Alloy  
Gold plated in contact area:  
Tin plated in termination  
Nickel Plated overall
- 1.3 Shell:Steel&Copper Alloy  
Nickel/Au Plated overall

2.characteristics:

- 2.1 Rating Voltage : 30V AC.
  - 2.2 Rating Current:  
5A for Vbus PIN;1.25A for Vconn PIN
  - 2.3 Contact Resistance:40 mΩ MAX.
  - 2.4 Insulation Resistance:100 MΩ MIN.
  - 2.5 Withstanding Voltage:AC 100V
  - 2.6 Mating force: 5~20N MAX
  - 2.7 Extraction force:8~20N Min
  - 2.8 Life test:10000Cycles MIN.
  - 2.9 Temperature Range: -30℃~+80℃.
- The product must be compliance ROHS

U573-089B-161038

- B:不锈钢镀镍
- 1:1u" Au
- 3:载带
- 1:黑色
- 6:LCP

TOLERANCE UNLESS OTHERWISE SPECIFIED	
.XXX ±0.10	.X' ±3'
.XX ±0.20	.XX' ±2'
.X ±0.30	

**FLW** 深圳市华联威电子科技有限公司  
HUA LIAN WEI TECHNOLOGY ELECTRONICS CO;LTD.

APPROVED		PART NAME:	USB 3.1 TYPE E KETA 20PIN 贴板式			
CHECKED		PART No:	U573-089B-161038		C	
DRAWN	weihong	PROJECTION:	UNIT:	SCALE	SHEET	REV.
DATE	2021.07.23		mm	1:1	10F1	A