

承 认 书

Approval Sheet

客户 (Customer): /

客户料号 (Cus .P/N): /

华联威料号 (HLW P/N): U142-0535-G61018

品名规格 (PronameSpec): MINI 5P/F 短体前插后贴

送样日期 (Delivery Date): 2022/06/17

承认日期 (Acknowledge Date): 2022/06/17

| | | | |
|---|------------------|---------------------------|--------------------|
| Approved No: | | 客 户 Customer | |
| 采 购 部 Purchasing Dept | 品 质 部 QC Dept | 工 程 部 Engineering Dept | 确 认 Approved By |
| | | | |
| 深 圳 市 华 联 威 电 子 科 技 有 限 公 司 SHEN ZHEN SHI HUA LIAN WEI ELECTRONICS TECHNOLOGY CO; LTD. | | | |
| 业 务 部 Sales Dept | 品 管 部 QC Dept | 工 程 部 Engineering Dept | 核 准 Checked By |
| 蒋成英 | 欠必锋 | 魏红 | 唐竹君 |

地址: 深圳市龙华区观澜街道桂香社区观澜桂花路 307 号

TEL: 0755-28888886 28888866

邮箱: hua@hlwconn.com

[Http://www.hlwconn.com](http://www.hlwconn.com)

目 录

Contents

| | |
|-------------|-----------|
| 图纸..... | Page03 |
| 产品规格书..... | Page04-09 |
| 产品检测报告..... | Page10-11 |
| 尺寸测试报告..... | Page12 |
| 电镀报告..... | Page13-14 |
| 盐雾报告..... | Page15 |
| 材质证明..... | Page16-17 |
| SGS..... | Page18-51 |

| | | |
|------|---------|-------|
| REV. | ECN.NO. | APPD. |
| A | / | LXQ |

规格说明:Specifications:

电气特性:Electrical:

1. 额定电流: Current Rating
1.0A/contact terminal
2. 额定电压: Voltage Rating
30V DC
3. 接触阻抗: Contact Resistance
50 milliohms MAX
4. 耐电压: Dielectric Withstanding Voltage:
300 V AC AT Sea Level
5. 绝缘阻抗: Insulation Resistance:
100MEGA ohms MIN

原材料:Raw material:

1. 塑胶: Plastic cement:
Hing Temperature Thermoplastics,
LCP Black
2. 端子: Contact: Copper Alloy C2680/C5191
3. 外壳: Shell: Copper Alloy C2680

电镀: Electroplate:

1. 端子: Contact: Plated Gold in Mating Area;
Tin On Solder Talls
2. 外壳: Shell:
Nickel Plating

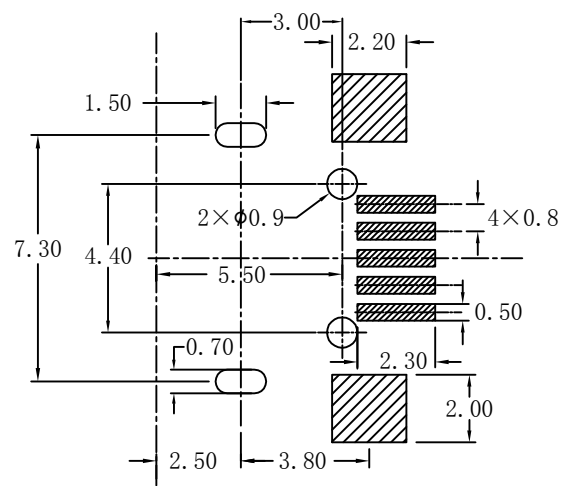
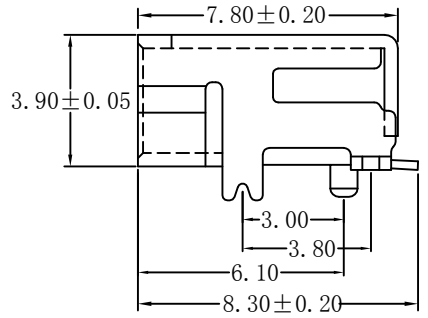
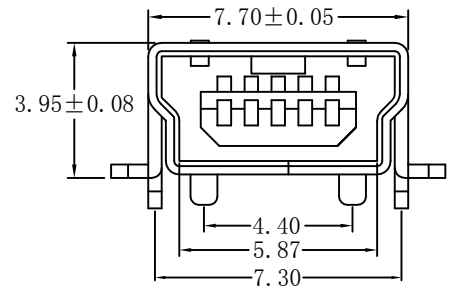
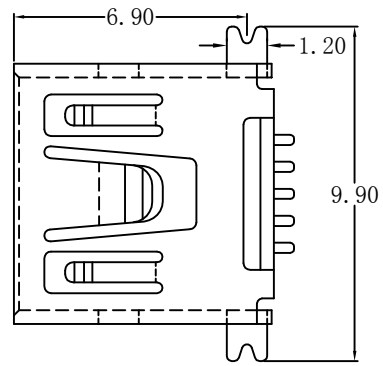

RECOMMENDED PCB LAYOUT

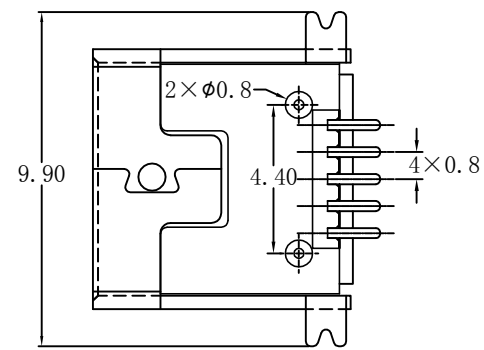

U142-0535-XXXX8

- 1: 半金1u"
- 3: 半金3u"
- 9: 镀全金1u"
- G: 镀半金G/Fu"
- 1: PA66
- 2: PBT
- 6: LCP
- 1: 吸塑盒
- 2: 吸塑管
- 3: 载带
- 6: 载带+贴麦拉
- 1: 黑色
- 2: 白色
- 3: 米黄色

| | | | | | | |
|--------------------------------------|-------------|---|-----------------|-------|-------|------|
| TOLERANCE UNLESS OTHERWISE SPECIFIED | | FLW 深圳市华联威电子科技有限公司 | | | | |
| .XXX ±0.10 | | HUA LIAN WEI TECHNOLOGY ELECTRONICS CO;LTD. | | | | |
| .XX ±0.20 | | | | | | |
| .X ±0.30 | | | | | | |
| APPROVED | | PART NAME: | MINI 5P短体前插后贴 | | | |
| CHECKED | | PART No: | U142-0535-XXXX8 | | | C |
| DRAWN | yangguifeng | PROJECTION: | UNIT: | SCALE | SHEET | REV. |
| DATE | 2021.10.29 | | mm | 1:1 | 10F1 | A |

MINI USB系列产品SPEC

版本版次: C

制定日期 20200707

适用范围 通用

1. Scope (范围)

1.1 Contents(内容)

This specification covers the performance, tests and quality requirements for the Electronics MINI USB Connector.

(此份产品规格适用于MINI USB连接器的产品功能，测试方法及质量要求)

2. Requirements (要求):

2.1 Rating(额定条件)

A. Voltage rating(额定电压):30V AC

B. Current rating(额定电流):1.5A

C. Operation Temperature Range(操作温度范围):-0°C to +50°C

3. Test Condition(测试条件):

3.1 Temperature range(温度范围):+15°C to +35°C

3.2 Humidity range (湿度范围):25% to 85%

4.1 Examination of product (产品外观)

| | | | |
|-------|--------------------------------|--------------|---|
| 4.1.1 | Examination of Product 产品外观 | Visual 目视 | No peeling off the plating deformation of the base or damage. 不得有电镀层剥落，塑料变形或破损 |
|-------|--------------------------------|--------------|---|

4.2. Electrical Performance(电气性能)

| | | | |
|-------|--|---|--|
| 4.2.1 | Contact Resistance 接触阻抗 | (EIA-364-06B) Mated connectors, Contact: measure by dry circuit, 30 m Volts maximum,20 mA 配对的连接器， 端子：测试端子在回路中施加直流最大30mV 20mA的电流再测端子的电阻值 | Initial Contact resistance Excluding conductor Resistance:50 mΩ max (Target design value) 接触电阻初始值最大不能超过50 mΩ (目标设计值) |
| 4.2.2 | Dielectric Withstanding Voltage (耐电压) | (EIA-364-20C) Unmated connectors, apply 100V AC (RMS.) for 1 minute between adjacent terminals of ground. 没有配对的连接器在相邻的端子或接地之间通上100V的交流电压1分钟 | 1. No Breakdown or flashover 2. Leakage current:0.5mA Max 1. 不能有损坏或跳火花 2. 漏电流<0.5mA |
| 4.2.3 | Insulation Resistance 绝缘阻抗 | (EIA-364-21C) Unmated connectors, apply 500V DC for 1 minute between adjacent terminals of ground. 没有配对的连接器在相邻的端子或接地之间通上500V的直流电压1分钟 | 100MΩ min (unmated) 没有配对需大于100 MΩ |

4.3 Mechanical Performance(机械性能)

| | | | |
|-------------------------------|---------------------------------------|---|--|
| 4.3.1 | Insertion/Withdrawal Force 插入力/拔出力 | (EIA-364-13) Insertion and withdrawal speed: 25mm/minute. 插入和拔出的速度为25mm/分 | Maximum insertion force 35N 插入力不超过35N(3.57kg) Withdrawal force 7N min 拔出力最小7N (0.70kg) After 5000 cycles 5N(0.5kgf)/MIN |
| 4.3.2 | Durability 寿命测试 | (EIA-364-09) Measure contact and shell resistance after the Following. Automatic cycling:5000 cycles at 100±5 Cycles per hour. 以每小时100±5插拔次数测试5000循环后测量端子和外壳的接触阻抗 | Contact Resistance 接触阻抗 Contact: Change from initial Value: 50 milliohms maximum. 端子: 从初始值开始变化量小于50 mΩ |
| 4.3.3 | Vibration 振动 | (EIA-364-28条件3) Amplitude:1.52mm P-P or 147m/s ² {15G} Sweep time: 50-2000-50Hz in 20 minutes. Duration: 12 times in each (total of 36 times) X, Y, Z, axes. Electrical load DC 100mA current shall be flowed during the test.(ANSI/EIA-364-28 Condition III) 在直流100毫安通电状态下测试, 在X,Y,Z垂直3方向上, 频率50-2000-50赫兹(加速度往复20分钟), 全振幅1.52mm P-P或147 m/s ² {15G}, 每轴12回计36回 | Appearance: No damage 外观: 无损坏 Contact Resistance 接触阻抗 Contact: Change from initial Value:50mΩ Max. 端子: 从初始值开始变化量小于50mΩ 间断性: 不超过1微秒 |
| 4.3.4 | Physical shock 冲击性 | (EIA-364-27条件A) Pulse width: 11msec Waveform: Half-sine 490m/s ² (50G) 3 strokes in each X, Y, Z axes. (ANSI/EIA-364-27 condition A) 周期: 11msec 冲击波形: 正弦半波490m/s ² (50G) 3循环在X, Y, Z 轴 | Appearance: No damage 外观: 无损坏 Contact Resistance 接触阻抗 Contact: Change from initial Value 50mΩ Max 端子: 从初始值开始变化量小于50mΩ Discontinuity: 1μ sec Max. 间断性: 不超过1微秒 |
| 4.4 Environmental Performance | | | |
| 4.4.1 | Thermal shock test 冷热冲击 | EIA-364-32C条件1) 10 cycles of: a)-55±3°C for 30 minutes b) +85±3°C for 30 minutes 10个循环, a)-55±3°C 30 分钟 b) +85±3°C 30 分钟 | Appearance: No Damage. 外观: 没有损坏 Contact Resistance 接触阻抗 Contact: Change from initial Value 50mΩ Max 端子: 从初始值开始变化量小于50mΩ |
| 4.4.2 | Solder ability 焊锡性 | (EIA-364-52) To be sipped in the solder bath 260±5°C Coverage for 3 seconds. 将焊锡脚浸在260±5°C的锡炉中<3秒 | The inspected area of each lead must have 90% solder coverage minimum |

| | | | |
|--------|--------------------|---|---|
| 4.4..3 | Humidity 恒温恒湿 | <p>(EIA-364-31B)</p> <p>(A) Mate connectors together and perform the test as follows 配对的连接器测试条件 Temperature: +25°C to +85°C(温度: +25°C到+85°C) Relative Humidity: 90% to 95%(相对湿度: 90%到95%) Duration:4 cycles(96 hours) (持续时间: 4个循环共96小时)</p> <p>Upon completion of the test, specimens shall be conditioned ambient room conditions for 24 hours, after which the specified measurements shall be performed. 试验完成后, 样品放置于室温条件中24小时后再进行测试</p> | <p>Appearance: No Damage 外观, 没有损坏</p> <p>Contact Resistance 接触阻抗 Contact: Change from initial Value 50mΩ Max 端子: 从初始值开始变化量小于50mΩ</p> |
| | | <p>(EIA-364-31B)</p> <p>(B) Unmated each connector and perform the test as follows. 没有配对的连接器测试条件 Temperature: +25°C to +85°C(温度: +25°C到+85°C) Relative Humidity: 90% to 95%(相对湿度: 90%到95%) Duration:4 cycles(96 hours) (持续时间: 4个循环共96小时)</p> <p>Upon completion of the test, specimens shall be conditioned ambient room conditions for 24 hours, after which the specified measurements shall be performed. 试验完成后, 样品放置于室温条件中24小时后再进行测试</p> | <p>Appearance: No Damage 外观, 没有损坏</p> <p>Conform to item of dielectric withstanding Voltage and Insulation Resistance. 符合耐电压及绝缘阻抗要求</p> |
| 4.4..4 | Salt Spray 盐水喷雾 | <p>EIA-364-26B)</p> <p>Temperature: 35±2°C 温度: 35±2°C Concentration for salt: 50% 盐水浓度: 5% (1)Duration: 12H 持续时间: 12小时 Condition(条件): Contact plated gold more than 15u" (include 15 u"),and the material of shell for copper alloy, or stainless. 端子镀金厚度大于等于15 u" 且壳体材质是铜合金或是不锈钢 (2) Duration: 12H 持续时间: 12小时 Condition(条件): Contact plated gold less than 15 u" ,and/or the material of shell for steel 端子镀金厚度小于15u" 且/或壳体材质是铁</p> | <p>No detrimental corrosion(Terminal solder tail unrequested) 产品无氧化, 锈蚀 (端子焊脚镀锡处不作要求)</p> <p>Contact Resistance 接触阻抗 Contact: Change from initial Value 50mΩ Max 端子: 从初始值开始变化量小于50mΩ</p> |

| | | | |
|--------|-------------------------------------|---|--|
| 4.4..5 | Cold resistance (Unmated) 冷阻抗 | <p>(EIA-364-17B)</p> <p>Unmated connectors and expose to $-25\pm 3^{\circ}\text{C}$ for 250 hours. Upon completion of the exposure period, the test specimens shall be conditioned at ambient room conditions for 1 to 2 hours, after which the specified measurements shall be performed.</p> <p>没配对的连接器放置于$-25\pm 3^{\circ}\text{C}$温度中250小时，当完成实验后，样品放置一般环境中1到</p> | <p>Appearance: No Damage. 外观：没有损坏</p> <p>Contact Resistance 接触阻抗 Contact: Change from initial Value 30mΩ Max</p> <p>端子：从初始值开始变化量小于50mΩ</p> |
| 4.4..6 | Heat resistance (Unmated) 热阻抗 | <p>(EIA-364-17B)</p> <p>Mated connectors and expose to $85\pm 2^{\circ}\text{C}$ for 250 hours. Upon completion of the exposure period, the test specimens shall be conditioned at ambient room conditions for 1 to 2 hours, after which the specified measurements shall be performed.</p> <p>配对的连接器放置于$85\pm 2^{\circ}\text{C}$温度中250小时，当完成实验后，样品放置一般环境中1到2小时后，在进行测试</p> | <p>Appearance: No Damage. 外观：没有损坏</p> <p>Contact Resistance 接触阻抗 Contact: Change from initial Value 50mΩ Max</p> <p>端子：从初始值开始变化量小于50mΩ</p> |
| 4.4..7 | Thermal Aging 高温老化 | <p>(EIA-364-31B, Condition 4, Method A)</p> <p>Unmated connectors and expose to $+85\pm 2^{\circ}\text{C}$ for 250 hours. Upon completion of the exposure period, the test specimens shall be conditioned at ambient room conditions for 1 to 2 hours, after which the specified measurements shall be performed.</p> <p>没配对的连接器放置于$+85\pm 2^{\circ}\text{C}$温度中250小时，当完成实验后，样品放置一般环境中1到2小时后，在进行测试</p> | <p>Appearance: No Damage. 外观：没有损坏</p> <p>Contact Resistance 接触阻抗 Contact: Change from initial Value 50mΩ Max</p> <p>端子：从初始值开始变化量小于50mΩ</p> |
| 4.4.8 | Resistance to Soldering Heat | <p>for wave soldering : mil-std-202f,method 210 A,test condition B 波峰焊: mil-std-202f, method 210 A, 试验条件B Pre-heat : 80°C, 60 Seconds 预热:80°C, 60秒 Temperature : $260 \pm 5^{\circ}\text{C}$ 温度:$260\pm 5^{\circ}\text{C}$ Immersion duration : 10 ± 1 sec. 浸泡时间:10 ± 1秒</p> <p>for manual soldering :手动焊接: mil-std-202f,method 210 A,test condition A Pre-heat : No 预热:没有 Temperature : $350 \pm 10^{\circ}\text{C}$ 温度:$350\pm 10^{\circ}\text{C}$ Immersion duration :3.5 ± 0.5 sec.浸泡时间:3.5 ± 0.5秒</p> | <p>No physical damage shall occur. 不可有损坏</p> |

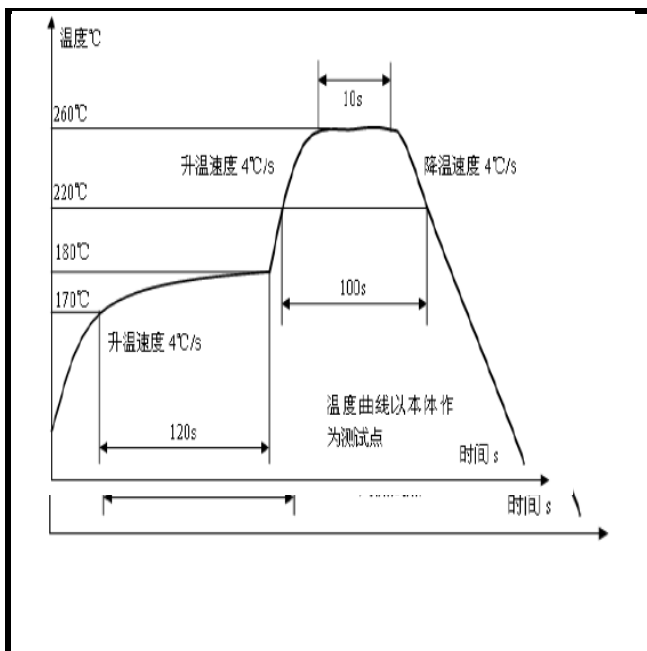

Note 1: Shall meet visual requirements, show no physical damage, and meet requirement of additional tests as specified in the test sequence in Figures 2

说明1: 测试要求不能有物理损坏, 测试依据表格二的顺序进行

3.Product Qualification And Requalification Test:产品测试顺序表 Figure 2

| Test or Examination | Test Group | | | | | | | | | | | | | |
|---------------------------------------|------------|-----|-----|---|-----|-----|-----|-----|-----|-----|-----|-----|-----|---|
| | A | B | C | D | E | F | G | H | I | J | K | L | M | N |
| Test Sequence | | | | | | | | | | | | | | |
| 4.1.1.Examination of Product 产品外观 | 1,9 | 1,3 | 1,5 | 1 | 1,5 | 1,5 | 1,5 | 1,3 | 1,5 | 1,5 | 1,5 | 1,5 | 1,5 | 1 |
| 4.2.1.Contact Resistance 接触阻抗 | 2,8 | | 2,4 | | 2,4 | 2,4 | 2,4 | | 2,4 | 2,4 | 2,4 | 2,4 | 2,4 | |
| 4.2.2.Dielectric Withstanding Voltage | 3,7 | | | | | | | | | | | | | |
| 4.2.3.Insulation Resistance 绝缘阻抗 | 4,6 | | | | | | | | | | | | | |
| 4.3.1.Insertion/Withdrawal force 插拔力 | | 2 | | | | | | | | | | | | |
| 4.3.2.Durability 寿命测试 | | | 3 | | | | | | | | | | | |
| 4.3.3.Vibration 振动性 | | | | | 3 | | | | | | | | | |
| 4.3.4.Physical shock 冲击性 | | | | | | 3 | | | | | | | | |
| 4.4.1.Thermal shock test 冷热冲击 | | | | | | | 3 | | | | | | | |
| 4.4.2.Solderability 焊锡性 | | | | | | | | 2 | | | | | | |
| 4.4.3.Humidity 恒温恒湿 | 5 | | | | | | | | 3 | | | | | |
| 4.4.4.Salt Spray 盐水喷雾 | | | | | | | | | | 3 | | | | |

| | | | | | | | | | | | | | | |
|----------------------------------|---|---|---|---|---|---|---|---|---|---|---|---|---|---|
| 4.4.5.Cold resistance 冷 阻抗 | | | | | | | | | | | 3 | | | |
| 4.4.6.Heat resistance 热 阻抗 | | | | | | | | | | | | 3 | | |
| 4.4.7.Thermal Aging 高 温老化 | | | | | | | | | | | | | 3 | |
| 4.4.8.IR-reflow 回流焊 测试 | | | | | | | | | | | | | | 2 |
| NO. of Test samples(Min.) 测试样 | 5 | 5 | 5 | 5 | 5 | 5 | 5 | 5 | 5 | 5 | 5 | 5 | 5 | 5 |

NOTE 2: (a) Numbers indicate sequence in which tests are performed.
(b) Discontinuities shall not take place in this test group, during tests.
说明 2: (a)测试依照矩阵要求数量进行。
(b)在测试中，群组测试不能间断

核准：唐竹君

制作人：魏红

| | | | | | | | | | | | |
|---|--------------------------|--|--|--------------------|------|------|------|------|------|---|--|
| 2 | Heat test | Temperature: 70±2°C Duration:168H | OVEN | No physical damage | Pass | Pass | Pass | Pass | Pass | P | |
| 3 | Cold test | Temperature: -25±3°C Duration:168H | PROGRAM CONTROLLED TEMP. & HUMIDTY CHAMBER | No physical damage | Pass | Pass | Pass | Pass | Pass | P | |
| 4 | Temperature cycling test | Temperature: 70 ~ -25 °C Duration:5 cycle | PROGRAM CONTROLLED TEMP. & HUMIDTY CHAMBER | No physical damage | Pass | Pass | Pass | Pass | Pass | P | |

四.物理測試 PHYSICAL TEST

| 序號 NO. | 測試項目 Testing Item | 測試條件 Testing Conditions | 測試設備 Testing Equipment | 規格 SPEC | 測試記錄 Testing Result | | | | | 判定 Judge | |
|-----------|-----------------------------------|---|-------------------------------------|---------------------|---------------------|------|------|------|------|----------|------|
| | | | | | 1 | 2 | 3 | 4 | 5 | Pass | Fail |
| 1 | Salt spray test | Temperature: 35±2°C Concentration:5±1 % Duration:12H | SALT SPRAY TESTER | No Oxidation | Pass | Pass | Pass | Pass | Pass | P | |
| 2 | Resistance to soldering heat test | Temperature: 260±5°C Duration:10±1sec | OVEN | No physical damage | Pass | Pass | Pass | Pass | Pass | P | |
| 3 | Solder ability test | Temperature: 260±5°C Duration:5±0.5 sec | CONTROLLED CONSTANT-TEMP SOLDER POT | Soldering area ≥95□ | Pass | Pass | Pass | Pass | Pass | P | |
| 判定 Result | | <input checked="" type="checkbox"/> 合格 (ACCEPT) <input type="checkbox"/> 不合格 (REJECT) | | | | | | | | | |

核准(Approver): 欠必鋒

測試(Tester): 但芬

檢驗報告

首件檢驗
 入庫檢驗
 出貨檢驗
 客退檢驗
 退料檢驗
 其他

2022年06月16日 版次:A1

| 料號 | U142-0535-G61018- | 制令單號 | / | | | | | 送檢單位 | 工程部 | 首件製作者 | 裝配 | | |
|---|-------------------|---|---------|------|------|------|-----------------|-----------------|----------------|----------|-----|-----|----|
| 品名 | MINI 5P/F 短体前插后贴 | 客戶代號 | / | | | | | 批 量 | / | 送檢時間 | / | | |
| | | | | | | | | 數 量 | 5PCS | 確認時間 | / | | |
| 抽樣標準 | | <input checked="" type="checkbox"/> 單次 <input type="checkbox"/> 雙次 | | | | | 抽樣數 (5PCS) | AQL | CRI:0 MAJ:0.40 | MIN:0.65 | | | |
| MIL-STD-105E(II) | | <input checked="" type="checkbox"/> 正常 <input type="checkbox"/> 加嚴 <input type="checkbox"/> 減量 | | | | | | ACC/REJ | 0 | / | / | | |
| 不良數: CRI (/) MAJ (/) MIN (/) | | | | | | | | 不良率(%) | | / | | | |
| NO. | 檢驗項目 單位:MM/G | 檢測 儀器 | 檢 驗 記 錄 | | | | | 品管判定 | | CRI | MAJ | MIN | 備注 |
| | | | 1 | 2 | 3 | 4 | 5 | AC | RE | | | | |
| | 7.70±0.05 | D | 7.73 | 7.74 | 7.72 | 7.73 | 7.73 | √ | | | | | |
| | 3.95±0.08 | D | 3.96 | 3.95 | 3.94 | 3.96 | 3.94 | √ | | | | | |
| | 4.40±0.20 | D | 4.45 | 4.42 | 4.43 | 4.44 | 4.42 | √ | | | | | |
| | 7.30±0.20 | D | 7.32 | 7.35 | 7.33 | 7.32 | 7.33 | √ | | | | | |
| | 6.90±0.20 | D | 6.93 | 6.95 | 6.94 | 6.95 | 6.93 | √ | | | | | |
| | 9.90±0.20 | D | 9.95 | 9.93 | 9.92 | 9.92 | 9.95 | √ | | | | | |
| | 7.80±0.20 | D | 7.83 | 7.85 | 7.83 | 7.86 | 7.83 | √ | | | | | |
| | 3.90±0.05 | D | 3.95 | 3.92 | 3.92 | 3.93 | 3.94 | √ | | | | | |
| | 8.30±0.20 | D | 8.34 | 8.31 | 8.32 | 8.31 | 8.34 | √ | | | | | |
| | | | | | | | | | | | | | |
| | | | | | | | | | | | | | |
| 檢驗依據: <input checked="" type="checkbox"/> 《工程圖紙》 <input type="checkbox"/> 《檢驗規範》 <input type="checkbox"/> 《承認書》 <input type="checkbox"/> 樣品 <input type="checkbox"/> 其它 | | | | | | | | | | | | | |
| 檢測儀器:A游標卡尺 B千分尺 C厚薄儀 D投影鏡 E放大鏡 F顯微鏡 G錫爐 H插拔力器 I間位尺 J其它 | | | | | | | | | | | | | |
| 品保判定: | | <input checked="" type="checkbox"/> 合格Accept <input type="checkbox"/> 退貨Reject <input type="checkbox"/> 特采Waive <input type="checkbox"/> 挑選Sort | | | | | | | | | | | |
| 核 准 APP | 欠必鋒 | 審 核 CHK | / | | | | | 檢 驗 員 INSPBY | 但 芬 | | | | |

保存期限:三年

保存部門:品保部

QR-M-003

| | | | | | |
|-------------------------------|----------|---------------|----|-----------|----------|
| 品名: MINI 5P/F 短体前插后贴 (端子) | | 版次:A.0 | | | |
| 电镀规格:Ni40u", Sn40u", Au G/Fu" | | 日期:2022-03-20 | | | |
| 页次:1/1 | | | | | |
| 厂商:同华 | | | | | |
| 测试设备:CMI X-射线膜厚测试仪 | | | | | |
| 1、底层电镀测试 (Ni) | | | | | |
| 数据 | 测试标准 | 实测值 | 判定 | 测试日期 | 测试时间 |
| 1 | 40u"MIN | 50.5u" | OK | 2022/3/20 | 10:20:15 |
| 2 | 40u"MIN | 56.3u" | OK | 2022/3/20 | 10:20:17 |
| 3 | 40u"MIN | 67.5u" | OK | 2022/3/20 | 10:20:19 |
| 4 | 40u"MIN | 62.4u" | OK | 2022/3/20 | 10:20:21 |
| 2、表层电镀测试 (Sn) | | | | | |
| 数据 | 测试标准 | 实测值 | 判定 | 测试日期 | 测试时间 |
| 1 | 40u"MIN | 65.3u" | OK | 2022/3/20 | 10:25:10 |
| 2 | 40u"MIN | 74.7u" | OK | 2022/3/20 | 10:25:12 |
| 3 | 40u"MIN | 75.9u" | OK | 2022/3/20 | 10:25:14 |
| 4 | 40u"MIN | 70.4u" | OK | 2022/3/20 | 10:25:16 |
| 3、表层电镀测试 (Au) | | | | | |
| 数据 | 测试标准 | 实测值 | 判定 | 测试日期 | 测试时间 |
| 1 | 0.5u"MIN | 0.56u" | OK | 2022/3/20 | 10:30:32 |
| 2 | 0.5u"MIN | 0.54u" | OK | 2022/3/20 | 10:30:34 |
| 3 | 0.5u"MIN | 0.57u" | OK | 2022/3/20 | 10:30:36 |
| 4 | 0.5u"MIN | 0.55u" | OK | 2022/3/20 | 10:30:38 |

核准: 欠必锋

审核: 李娟

检验员: 但芬

盐水喷雾实验报告

| | | | |
|--------|----------------------------------|--------|----------------------|
| 试验方法 | 盐水喷雾腐蚀试验法 | 参考资料 | MIL-STD-1216 |
| METHOD | NEUTRL SALT SPRAY CORROSION TEST | REF | |
| 客户 | / | 试验起始日期 | 2022年06月16日 20:00 时起 |
| | | DATE | 2022年06月17日 08:00 时止 |
| 样品名称 | MINI 5P/F 短体前插后贴 | 试验数量 | 5PCS |
| P/N | U142-0535-G61018 | | |

试验条件 (TEST CONDDITION)

- 1、盐水溶解 (SALT SOLUTION: 浓度 $50 \pm 10\text{g/L}$, PH值6.5-7.2).
- 2、试验室温度 (TEMP. IT THE SPRAY DHAMBR): $35 \pm 1^\circ\text{C}$.
- 3、盐水桶温度 (TEMP. OF SALE SOL' N TANK): $35 \pm 1^\circ\text{C}$.
- 4、压力桶温度 (TEMP. OF SAR SUPPLIERY): $47 \pm 1^\circ\text{C}$.
- 5、试验室相对湿度 (R. H IN THE CHAMBER) 85%.
- 6、压缩空气压力 (COMPRESSED AIR PRESSURE): $1.00 \pm 0.01\text{Kg/cm}^2$.
- 7、样品放置位置 (SPECIMEN SUPPORTED ANGLE): 尼龙绳吊挂 $70^\circ - 90^\circ$.
- 8、喷雾收集量 (COLLECT RATE OF SALT SOL' N) $1-2\text{mL}/(8 \text{ cm}^2\text{hr})$.
- 9、盐雾测试时间: 12小时 (H)

判定方法 (ADFUSGD METHOD)

试验后以20倍放大镜观察、无蓝、绿色腐蚀物之现象 (不包含折弯处), 即判定合格. (Inspext the ecimen at 20 xmagnification no blue or green corrosion products are acceptable)

| 样品序号 | 试验后现象 | 判定 |
|------|-----------------------|---------|
| | PHENOMENON AFTER TEST | COMMENT |
| 1 | 无蓝、绿色腐蚀物之现象 | OK |
| 2 | 无蓝、绿色腐蚀物之现象 | OK |
| 3 | 无蓝、绿色腐蚀物之现象 | OK |
| 4 | 无蓝、绿色腐蚀物之现象 | OK |
| 5 | 无蓝、绿色腐蚀物之现象 | OK |
| | | |
| | | |
| | | |

核准: 欠必锋

审核: 李娟

试验员: 但芬

Materials Information

PRODUCT NAME: LCP M-401 BK

COMPOSITION/INFORMATION OF LCP M-401 BK

SUBSTANCE/MIXTURE: Mixture

SYNONYM(S): Aromatic Liquid Crystal Polymer(LCP)

| 品名 | 比例 | 用途 |
|------------|-------|------------|
| 德众泰 LCP 树脂 | 0.565 | 构成材料主要成分 |
| 抗氧化剂 | 0.002 | 抗氧化 |
| 科莱恩热稳定剂 | 0.003 | 增加高温稳定性 |
| 黑色母 | 0.01 | 着色 |
| 滑石粉 | 0.2 | 增强剂, 增加流动性 |
| 玻纤 | 0.22 | 增强 |

NAME OF COMPANY: DZT Engineering Plastics Tech. Co.,Ltd

ADDRESS: Building 2 Zhichong Industrial Park, Hi-Tech Zone, Jiangmen City,
Guangdong Province, China

SECTION IN CHARGE: Quality Assurance Department

TEL/FAX: +86-750-3689920/+86-750-3689921

EMERGENCY TEL: +86-750-3689708



鉅鼎銅材廠檢驗報告單

| | | | | | | | | | | |
|------------------------------|--------------------------|----------------------|--------------------------------|------------------------|-----------------------------------|-----------------------------|--------------------------------------|-----------------------|------|----|
| 公司名稱 Customer | 鉅鼎銅材廠檢驗報告單 | | | | 重量 Weight(kg) | 1078 | 出貨日期 Date | 2021/11/23 | | |
| 品名 Article | 標準 Standard No | | | | 尺寸 Dimension | | 狀態 Temper | 銅卷編號 Coil No | | |
| C2680 | JISH3100:2017 | | | | 0.18*400 | | EH | 1021-C-08 | | |
| 化學成分Chemical Compositions(%) | | | | | | | | | | |
| 元素 Element | Cu % | Zn% | Pb% | Fe% | \ | \ | \ | \ | 化學成分 | 雜質 |
| 規範 Spec | 64.0-68.0 | 餘量 | <0.05 | <0.05 | \ | \ | \ | \ | 合格 | 合格 |
| 實測 Actual | 64.32 | 餘量 | 0.0036 | 0.0136 | \ | \ | \ | \ | 合格 | 合格 |
| 機械性質Mechanical Properties | | | | | | | | | | |
| 項目 Item | 結晶粒度 Grain Size Mm | 硬度 Hardness Hv | 抗拉強度 TensionStrength Mpa | 伸長度 Elongation % | 導電率 Electrical Conduc %IACS | 彎曲試驗 Bending Test 180 | 表面粗度 Surface Roughness Ra(u m) | 彎曲度 Camber mm/n | | |
| 規範MAX Spec | \ | 170-190 | 490-610 | \ | \ | \ | \ | \ | | |
| 實測 Actual | \ | 178 | 574 | 5 | \ | \ | \ | \ | | |

品質部



Test Report

No. CANEC2222380708

Date: 26 Oct 2022

Page 1 of 6

Client Name : SHENZHEN HUALIANWEI ELECTRONICS TECHNOLOGY CO.,LTD

Client Address : 101, 201, PLANT 1, NO.307, GUANLAN GUIHUA ROAD, GUIXIANG COMMUNITY, GUANLAN SUB-DISTRICT, LONGHUA DISTRICT, SHENZHEN CITY, GUANGDONG PROVINCE, CHINA

Sample Name : LCP plastic black color

Model No. : LCP Plastic

Client Ref. Info. : Used for USB series, HDMI series, RJ series, 1394 series, MICRO series, MINI series, DISPLAYPORT series, VGA series, DVI series, TYPE-C series, JACK series

The above sample(s) and information were provided by the client.

SGS Job No. : CP22-057100 - GZ

Date of Sample Received : 20 Oct 2022

Testing Period : 20 Oct 2022 - 26 Oct 2022

Test Requested : Selected test(s) as requested by the client.

Test Method(s) : Please refer to next page(s).

Test Result(s) : Please refer to next page(s).

Result Summary :

| Test Requested | Conclusion |
|--|------------|
| EU RoHS Directive (EU) 2015/863 amending Annex II to Directive 2011/65/EU- Lead, Mercury, Cadmium, Hexavalent chromium, Polybrominated biphenyls (PBBs), Polybrominated diphenyl ethers (PBDEs), Bis(2-ethylhexyl) phthalate (DEHP), Butyl benzyl phthalate (BBP), Dibutyl phthalate (DBP) and Diisobutyl phthalate (DIBP) | PASS |

Signed for and on behalf of
SGS-CSTC Standards Technical Services Co., Ltd. Guangzhou Branch

Dongyu Xie

Dongyu Xie
Approved Signatory

scan to see the report



689ECF7B



Test Report

No. CANEC2222380708

Date: 26 Oct 2022

Page 2 of 6

Test Result(s) :

Test Part Description :

| Specimen No. | SGS Sample ID | Description |
|--------------|------------------|---------------|
| SN1 | CAN22-223807.008 | Black plastic |

Remarks :

- (1) 1 mg/kg = 0.0001%
- (2) MDL = Method Detection Limit
- (3) ND = Not Detected (< MDL)
- (4) "-" = Not Regulated

EU RoHS Directive (EU) 2015/863 amending Annex II to Directive 2011/65/EU- Lead, Mercury, Cadmium, Hexavalent chromium, Polybrominated biphenyls (PBBs), Polybrominated diphenyl ethers (PBDEs), Bis(2-ethylhexyl) phthalate (DEHP), Butyl benzyl phthalate (BBP), Dibutyl phthalate (DBP) and Diisobutyl phthalate (DIBP)

Test Method : With reference to IEC 62321-4:2013+A1:2017, IEC 62321-5:2013, IEC 62321-7-2:2017 , IEC 62321-6:2015 and IEC 62321-8:2017, analyzed by ICP-OES , UV-Vis and GC-MS .

| <u>Test Item(s)</u> | <u>Limit</u> | <u>Unit</u> | <u>MDL</u> | <u>008</u> |
|----------------------------|--------------|-------------|------------|------------|
| Cadmium (Cd) | 100 | mg/kg | 2 | ND |
| Lead (Pb) | 1000 | mg/kg | 2 | 6 |
| Mercury (Hg) | 1000 | mg/kg | 2 | ND |
| Hexavalent Chromium (CrVI) | 1000 | mg/kg | 8 | ND |
| Sum of PBBs | 1000 | mg/kg | - | ND |
| Monobromobiphenyl | - | mg/kg | 5 | ND |
| Dibromobiphenyl | - | mg/kg | 5 | ND |
| Tribromobiphenyl | - | mg/kg | 5 | ND |
| Tetrabromobiphenyl | - | mg/kg | 5 | ND |
| Pentabromobiphenyl | - | mg/kg | 5 | ND |
| Hexabromobiphenyl | - | mg/kg | 5 | ND |
| Heptabromobiphenyl | - | mg/kg | 5 | ND |
| Octabromobiphenyl | - | mg/kg | 5 | ND |
| Nonabromobiphenyl | - | mg/kg | 5 | ND |
| Decabromobiphenyl | - | mg/kg | 5 | ND |
| Sum of PBDEs | 1000 | mg/kg | - | ND |
| Monobromodiphenyl ether | - | mg/kg | 5 | ND |
| Dibromodiphenyl ether | - | mg/kg | 5 | ND |
| Tribromodiphenyl ether | - | mg/kg | 5 | ND |
| Tetrabromodiphenyl ether | - | mg/kg | 5 | ND |



Unless otherwise agreed in writing, this document is issued by the Company subject to its General Conditions of Service printed overleaf, available on request or accessible at <http://www.sgs.com/en/Terms-and-Conditions.aspx> and, for electronic format documents, subject to Terms and Conditions for Electronic Documents at <http://www.sgs.com/en/Terms-and-Conditions/Terms-e-Documents.aspx>. Attention is drawn to the limitation of liability, indemnification and jurisdiction issues defined therein. Any holder of this document is advised that information contained hereon reflects the Company's findings at the time of its intervention only and within the limits of Client's instructions, if any. The Company's sole responsibility is to its Client and this document does not exonerate parties to a transaction from exercising all their rights and obligations under the transaction documents. This document cannot be reproduced except in full, without prior written approval of the Company. Any unauthorized alteration, forgery or falsification of the content or appearance of this document is unlawful and offenders may be prosecuted to the fullest extent of the law. Unless otherwise stated the results shown in this test report refer only to the sample(s) tested.

Attention: To check the authenticity of testing /inspection report & certificate, please contact us at telephone: (86-755) 8307 1443, or email: CN.Doccheck@sgs.com

Test Report

No. CANEC2222380708

Date: 26 Oct 2022

Page 3 of 6

| <u>Test Item(s)</u> | <u>Limit</u> | <u>Unit</u> | <u>MDL</u> | <u>008</u> |
|-------------------------------------|--------------|-------------|------------|------------|
| Pentabromodiphenyl ether | - | mg/kg | 5 | ND |
| Hexabromodiphenyl ether | - | mg/kg | 5 | ND |
| Heptabromodiphenyl ether | - | mg/kg | 5 | ND |
| Octabromodiphenyl ether | - | mg/kg | 5 | ND |
| Nonabromodiphenyl ether | - | mg/kg | 5 | ND |
| Decabromodiphenyl ether | - | mg/kg | 5 | ND |
| Dibutyl phthalate (DBP) | 1000 | mg/kg | 50 | ND |
| Butyl benzyl phthalate (BBP) | 1000 | mg/kg | 50 | ND |
| Bis (2-ethylhexyl) phthalate (DEHP) | 1000 | mg/kg | 50 | ND |
| Diisobutyl Phthalates (DIBP) | 1000 | mg/kg | 50 | ND |

Notes :

- (1) The maximum permissible limit is quoted from RoHS Directive (EU) 2015/863.
- (2) IEC 62321 series is equivalent to EN 62321 series
- (3) The restriction of DEHP, BBP, DBP and DIBP shall apply to medical devices, including in vitro medical devices, and monitoring and control instruments, including industrial monitoring and control instruments, from 22 July 2021.

Unless otherwise stated, the decision rule for conformity reporting is based on Binary Statement for Simple Acceptance Rule ($w=0$) stated in ILAC-G8:09/2019.



Unless otherwise agreed in writing, this document is issued by the Company subject to its General Conditions of Service printed overleaf, available on request or accessible at <http://www.sgs.com/en/Terms-and-Conditions.aspx> and, for electronic format documents, subject to Terms and Conditions for Electronic Documents at <http://www.sgs.com/en/Terms-and-Conditions/Terms-e-Documents.aspx>. Attention is drawn to the limitation of liability, indemnification and jurisdiction issues defined therein. Any holder of this document is advised that information contained hereon reflects the Company's findings at the time of its intervention only and within the limits of Client's instructions, if any. The Company's sole responsibility is to its Client and this document does not exonerate parties to a transaction from exercising all their rights and obligations under the transaction documents. This document cannot be reproduced except in full, without prior written approval of the Company. Any unauthorized alteration, forgery or falsification of the content or appearance of this document is unlawful and offenders may be prosecuted to the fullest extent of the law. Unless otherwise stated the results shown in this test report refer only to the sample(s) tested.

Attention: To check the authenticity of testing / inspection report & certificate, please contact us at telephone: (86-755) 8307 1443, or email: CN.Doccheck@sgs.com

ATTACHMENTS

Pb/Cd/Hg/Cr⁶⁺/PBBs/PBDEs Testing Flow Chart

1) These samples were dissolved totally by pre-conditioning method according to below flow chart. (Cr⁶⁺ and PBBs/PBDEs test method excluded).

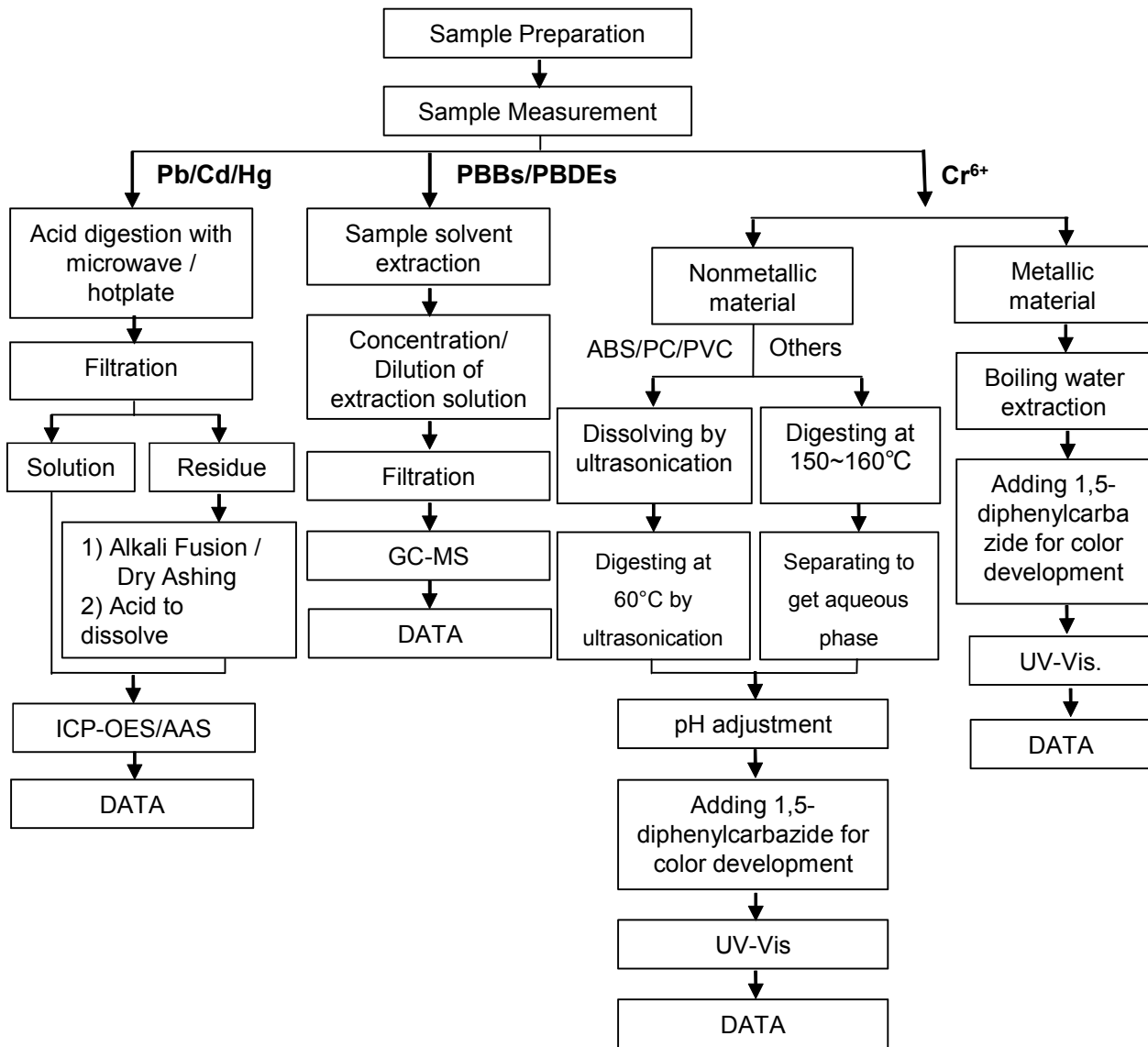

ATTACHMENTS

Phthalates Testing Flow Chart

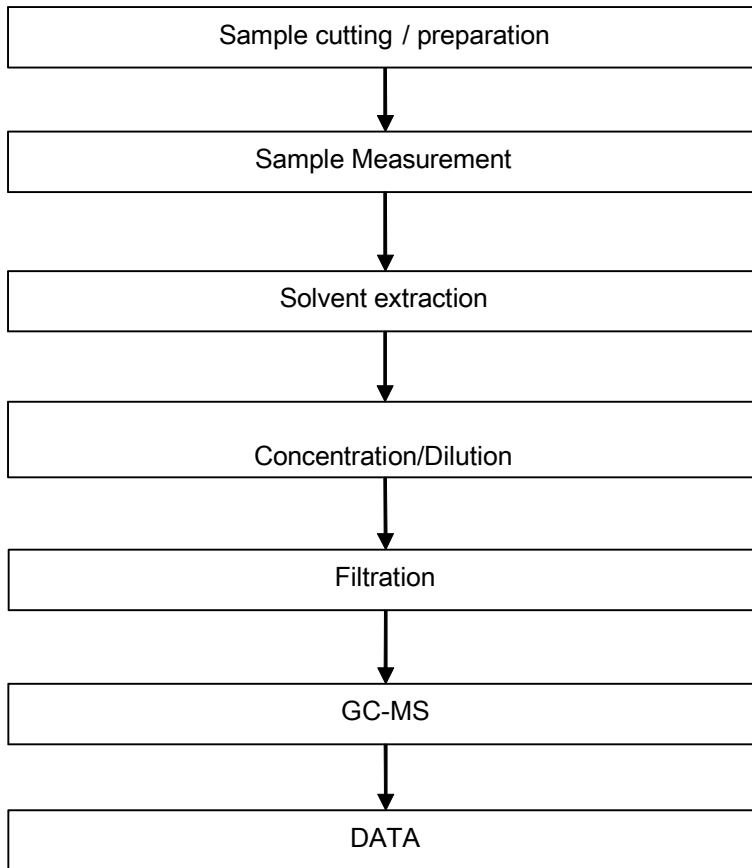

Unless otherwise agreed in writing, this document is issued by the Company subject to its General Conditions of Service printed overleaf, available on request or accessible at <http://www.sgs.com/en/Terms-and-Conditions.aspx> and, for electronic format documents, subject to Terms and Conditions for Electronic Documents at <http://www.sgs.com/en/Terms-and-Conditions/Terms-e-Document.aspx>. Attention is drawn to the limitation of liability, indemnification and jurisdiction issues defined therein. Any holder of this document is advised that information contained hereon reflects the Company's findings at the time of its intervention only and within the limits of Client's instructions, if any. The Company's sole responsibility is to its Client and this document does not exonerate parties to a transaction from exercising all their rights and obligations under the transaction documents. This document cannot be reproduced except in full, without prior written approval of the Company. Any unauthorized alteration, forgery or falsification of the content or appearance of this document is unlawful and offenders may be prosecuted to the fullest extent of the law. Unless otherwise stated the results shown in this test report refer only to the sample(s) tested.

Attention: To check the authenticity of testing / inspection report & certificate, please contact us at telephone: (86-755) 8307 1443, or email: CN.Doccheck@sgs.com

Sample photo:



SGS authenticate the photo on original report only

*** End of Report ***



Test Report

No. CANEC2222380702

Date: 26 Oct 2022

Page 1 of 4

Client Name : SHENZHEN HUALIANWEI ELECTRONICS TECHNOLOGY CO.,LTD

Client Address : 101, 201, PLANT 1, NO.307, GUANLAN GUIHUA ROAD, GUIXIANG COMMUNITY, GUANLAN SUB-DISTRICT, LONGHUA DISTRICT, SHENZHEN CITY, GUANGDONG PROVINCE, CHINA

Sample Name : C2680 Copper shell

Model No. : C2680 shell after plating

Client Ref. Info. : Used for USB series, HDMI series, RJ series, 1394 series, MICRO series, MINI series, DISPLAYPORT series, VGA series, DVI series, TYPE-C series, JACK series

The above sample(s) and information were provided by the client.

SGS Job No. : CP22-057100 - GZ

Date of Sample Received : 20 Oct 2022

Testing Period : 20 Oct 2022 - 26 Oct 2022

Test Requested : Selected test(s) as requested by the client.

Test Method(s) : Please refer to next page(s).

Test Result(s) : Please refer to next page(s).

Result Summary :

| Test Requested | Conclusion |
|---|------------|
| EU RoHS Directive (EU) 2015/863 amending Annex II to Directive 2011/65/EU- Lead, Mercury, Cadmium and Hexavalent chromium | PASS |

Signed for and on behalf of
SGS-CSTC Standards Technical Services Co., Ltd. Guangzhou Branch

Dongyu Xie

Dongyu Xie
Approved Signatory

scan to see the report



E0D80CC0



SGS-CSTC Standards Technical Services Co., Ltd.
Guangzhou Branch Testing Center Chemical Laboratory

Unless otherwise agreed in writing, this document is issued by the Company subject to its General Conditions of Service printed overleaf, available on request or accessible at <http://www.sgs.com/en/Terms-and-Conditions.aspx> and, for electronic format documents, subject to Terms and Conditions for Electronic Documents at <http://www.sgs.com/en/Terms-and-Conditions/Terms-e-Documents.aspx>. Attention is drawn to the limitation of liability, indemnification and jurisdiction issues defined therein. Any holder of this document is advised that information contained hereon reflects the Company's findings at the time of its intervention only and within the limits of Client's instructions, if any. The Company's sole responsibility is to its Client and this document does not exonerate parties to a transaction from exercising all their rights and obligations under the transaction documents. This document cannot be reproduced except in full, without prior written approval of the Company. Any unauthorized alteration, forgery or falsification of the content or appearance of this document is unlawful and offenders may be prosecuted to the fullest extent of the law. Unless otherwise stated the results shown in this test report refer only to the sample(s) tested.

Attention: To check the authenticity of testing / inspection report & certificate, please contact us at telephone: (86-755) 8307 1443, or email: CN.Doccheck@sgs.com

198 Kazhu Road, Sciencetech Park Guangzhou Economic & Technology Development District, Guangzhou, China 510663

中国·广州·经济技术开发区科学城科珠路198号 邮编: 510663

t (86-20) 82155555 www.sgs.com

t (86-20) 82155555 sgs.china@sgs.com

Test Report

No. CANEC2222380702

Date: 26 Oct 2022

Page 2 of 4

Test Result(s) :

Test Part Description :

| Specimen No. | SGS Sample ID | Description |
|--------------|------------------|--------------------------|
| SN1 | CAN22-223807.002 | Silver-grey plated metal |

Remarks :

- (1) 1 mg/kg = 0.0001%
- (2) MDL = Method Detection Limit
- (3) ND = Not Detected (< MDL)
- (4) "-" = Not Regulated

EU RoHS Directive (EU) 2015/863 amending Annex II to Directive 2011/65/EU- Lead, Mercury, Cadmium and Hexavalent chromium

Test Method : With reference to IEC 62321-4:2013+A1:2017, IEC 62321-5:2013, IEC 62321-7-1:2015, analyzed by ICP-OES and UV-Vis .

| <u>Test Item(s)</u> | <u>Limit</u> | <u>Unit</u> | <u>MDL</u> | <u>002</u> |
|-------------------------------|--------------|--------------------|------------|------------|
| Cadmium (Cd) | 100 | mg/kg | 2 | ND |
| Lead (Pb) | 1000 | mg/kg | 2 | 37 |
| Mercury (Hg) | 1000 | mg/kg | 2 | ND |
| Hexavalent Chromium (Cr(VI))▼ | - | µg/cm ² | 0.10 | ND |

Notes :

- (1) The maximum permissible limit is quoted from RoHS Directive (EU) 2015/863.
 - (2) IEC 62321 series is equivalent to EN 62321 series
 - (3) ▼= a. The sample is positive for CrVI if the CrVI concentration is greater than 0.13 µg/cm². The sample coating is considered to contain CrVI
 b. The sample is negative for CrVI if CrVI is ND (concentration less than 0.10 µg/cm²). The coating is considered a non-CrVI based coating
 c. The result between 0.10 µg/cm² and 0.13 µg/cm² is considered to be inconclusive - unavoidable coating variations may influence the determination
- Information on storage conditions and production date of the tested sample is unavailable and thus Cr(VI) results represent status of the sample at the time of testing.

Unless otherwise stated, the decision rule for conformity reporting is based on Binary Statement for Simple Acceptance Rule ($w=0$) stated in ILAC-G8:09/2019.



ATTACHMENTS

Pb/Cd/Hg/Cr⁶⁺ Testing Flow Chart

1) These samples were dissolved totally by pre-conditioning method according to below flow chart. (Cr⁶⁺ test method excluded).

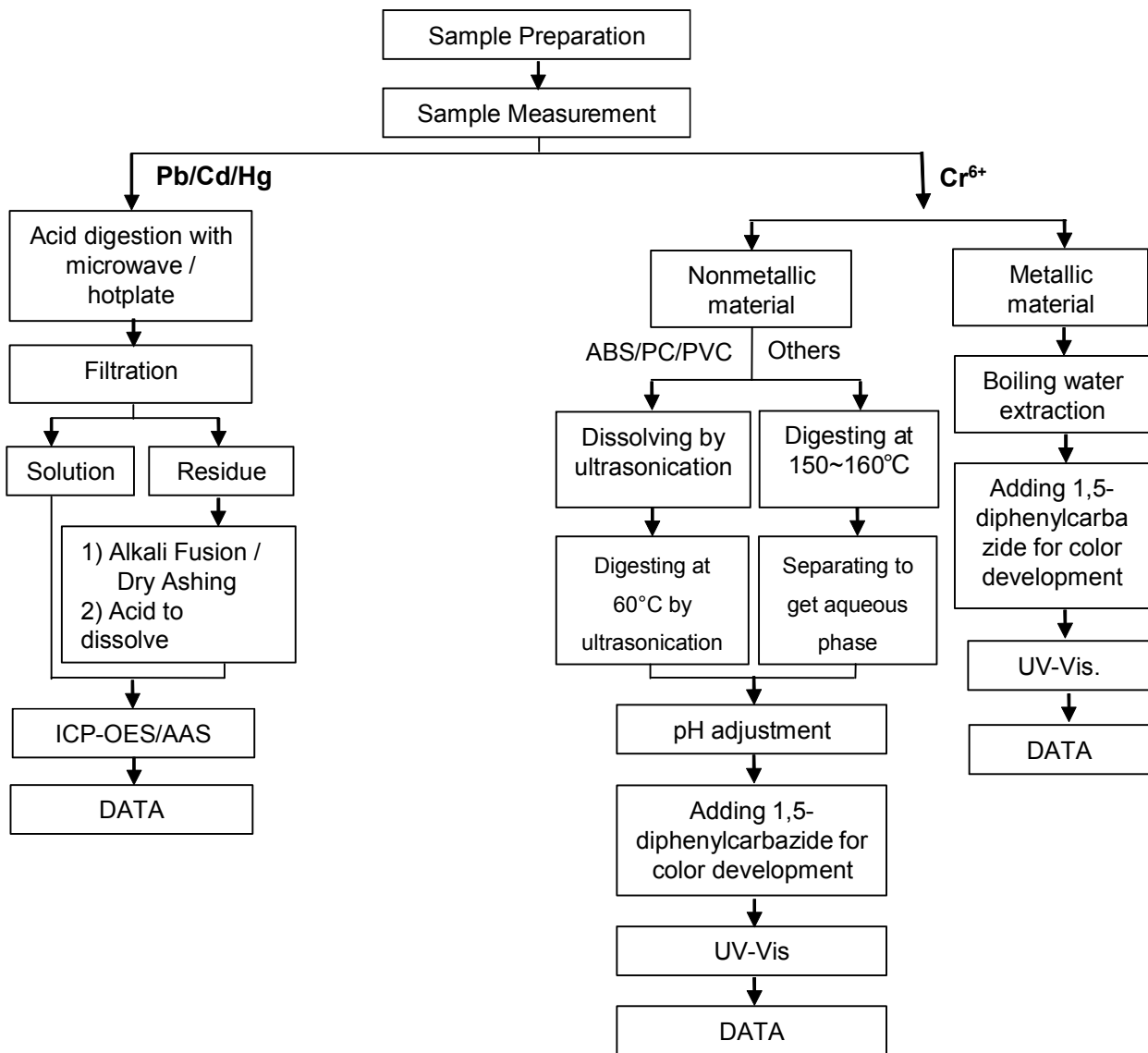

Sample photo:



SGS authenticate the photo on original report only

*** End of Report ***



Test Report

No. CANEC2222380701

Date: 26 Oct 2022

Page 1 of 4

Client Name : SHENZHEN HUALIANWEI ELECTRONICS TECHNOLOGY CO.,LTD

Client Address : 101, 201, PLANT 1, NO.307, GUANLAN GUIHUA ROAD, GUIXIANG COMMUNITY, GUANLAN SUB-DISTRICT, LONGHUA DISTRICT, SHENZHEN CITY, GUANGDONG PROVINCE, CHINA

Sample Name : C2680 Terminal

Model No. : C2680 terminal after plating

Client Ref. Info. : Used for USB series, HDMI series, RJ series, 1394 series, MICRO series, MINI series, DISPLAYPORT series, VGA series, DVI series, TYPE-C series, JACK series

The above sample(s) and information were provided by the client.

SGS Job No. : CP22-057100 - GZ

Date of Sample Received : 20 Oct 2022

Testing Period : 20 Oct 2022 - 26 Oct 2022

Test Requested : Selected test(s) as requested by the client.

Test Method(s) : Please refer to next page(s).

Test Result(s) : Please refer to next page(s).

Result Summary :

| Test Requested | Conclusion |
|---|------------|
| EU RoHS Directive (EU) 2015/863 amending Annex II to Directive 2011/65/EU- Lead, Mercury, Cadmium and Hexavalent chromium | PASS |

Signed for and on behalf of
SGS-CSTC Standards Technical Services Co., Ltd. Guangzhou Branch

Dongyu Xie

Dongyu Xie
Approved Signatory

scan to see the report



A17521CE



Test Report

No. CANEC2222380701

Date: 26 Oct 2022

Page 2 of 4

Test Result(s) :

Test Part Description :

| Specimen No. | SGS Sample ID | Description |
|--------------|------------------|--------------------------|
| SN1 | CAN22-223807.001 | Silver-grey/brassy metal |

Remarks :

- (1) 1 mg/kg = 0.0001%
- (2) MDL = Method Detection Limit
- (3) ND = Not Detected (< MDL)
- (4) "-" = Not Regulated

EU RoHS Directive (EU) 2015/863 amending Annex II to Directive 2011/65/EU- Lead, Mercury, Cadmium and Hexavalent chromium

Test Method : With reference to IEC 62321-4:2013+A1:2017, IEC 62321-5:2013, IEC 62321-7-1:2015, analyzed by ICP-OES and UV-Vis .

| <u>Test Item(s)</u> | <u>Limit</u> | <u>Unit</u> | <u>MDL</u> | <u>001</u> |
|-------------------------------|--------------|--------------------|------------|------------|
| Cadmium (Cd) | 100 | mg/kg | 2 | ND |
| Lead (Pb) | 1000 | mg/kg | 2 | 3 |
| Mercury (Hg) | 1000 | mg/kg | 2 | ND |
| Hexavalent Chromium (Cr(VI))▼ | - | µg/cm ² | 0.10 | ND |

Notes :

- (1) The maximum permissible limit is quoted from RoHS Directive (EU) 2015/863.
 - (2) IEC 62321 series is equivalent to EN 62321 series
 - (3) ▼= a. The sample is positive for CrVI if the CrVI concentration is greater than 0.13 µg/cm². The sample coating is considered to contain CrVI
 b. The sample is negative for CrVI if CrVI is ND (concentration less than 0.10 µg/cm²). The coating is considered a non-CrVI based coating
 c. The result between 0.10 µg/cm² and 0.13 µg/cm² is considered to be inconclusive - unavoidable coating variations may influence the determination
- Information on storage conditions and production date of the tested sample is unavailable and thus Cr(VI) results represent status of the sample at the time of testing.

Unless otherwise stated, the decision rule for conformity reporting is based on Binary Statement for Simple Acceptance Rule (w=0) stated in ILAC-G8:09/2019.



Unless otherwise agreed in writing, this document is issued by the Company subject to its General Conditions of Service printed overleaf, available on request or accessible at <http://www.sgs.com/en/Terms-and-Conditions.aspx> and, for electronic format documents, subject to Terms and Conditions for Electronic Documents at <http://www.sgs.com/en/Terms-and-Conditions/Terms-e-Documents.aspx>. Attention is drawn to the limitation of liability, indemnification and jurisdiction issues defined therein. Any holder of this document is advised that information contained hereon reflects the Company's findings at the time of its intervention only and within the limits of Client's instructions, if any. The Company's sole responsibility is to its Client and this document does not exonerate parties to a transaction from exercising all their rights and obligations under the transaction documents. This document cannot be reproduced except in full, without prior written approval of the Company. Any unauthorized alteration, forgery or falsification of the content or appearance of this document is unlawful and offenders may be prosecuted to the fullest extent of the law. Unless otherwise stated the results shown in this test report refer only to the sample(s) tested.

Attention: To check the authenticity of testing /inspection report & certificate, please contact us at telephone: (86-755) 8307 1443, or email: CN.Doccheck@sgs.com

ATTACHMENTS

Pb/Cd/Hg/Cr⁶⁺ Testing Flow Chart

1) These samples were dissolved totally by pre-conditioning method according to below flow chart. (Cr⁶⁺ test method excluded).

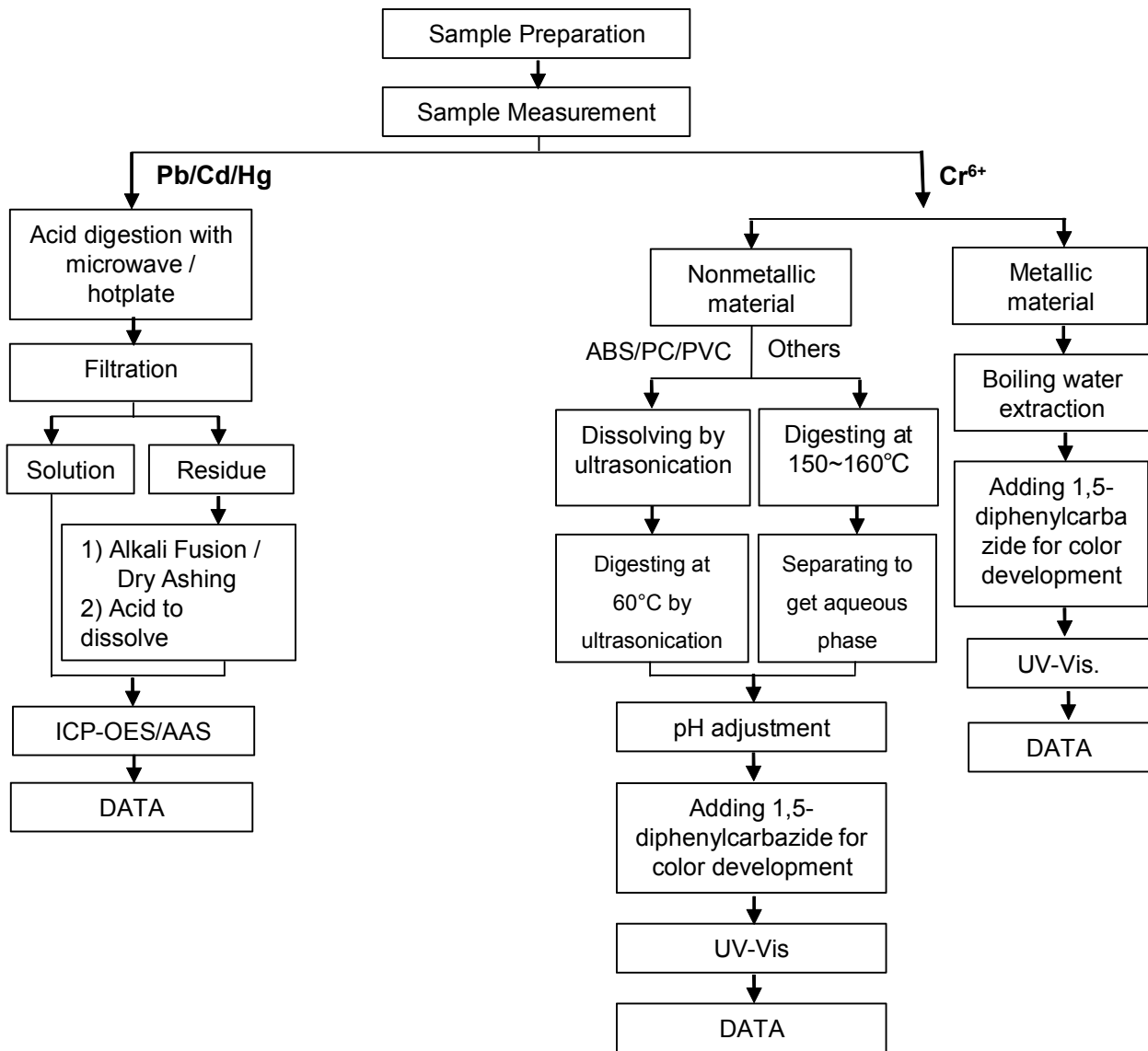

Unless otherwise agreed in writing, this document is issued by the Company subject to its General Conditions of Service printed overleaf, available on request or accessible at <http://www.sgs.com/en/Terms-and-Conditions.aspx> and, for electronic format documents, subject to Terms and Conditions for Electronic Documents at <http://www.sgs.com/en/Terms-and-Conditions/Terms-e-Documents.aspx>. Attention is drawn to the limitation of liability, indemnification and jurisdiction issues defined therein. Any holder of this document is advised that information contained hereon reflects the Company's findings at the time of its intervention only and within the limits of Client's instructions, if any. The Company's sole responsibility is to its Client and this document does not exonerate parties to a transaction from exercising all their rights and obligations under the transaction documents. This document cannot be reproduced except in full, without prior written approval of the Company. Any unauthorized alteration, forgery or falsification of the content or appearance of this document is unlawful and offenders may be prosecuted to the fullest extent of the law. Unless otherwise stated the results shown in this test report refer only to the sample(s) tested.

Attention: To check the authenticity of testing / inspection report & certificate, please contact us at telephone: (86-755) 8307 1443, or email: CN.Doccheck@sgs.com

Sample photo:



SGS authenticate the photo on original report only

*** End of Report ***



Test Report

No. CANEC2218227002

Date: 30 Aug 2022

Page 1 of 8

Client Name : SHENZHEN CITY TONGHUA INDUSTRY CO.,LTD

Client Address : TONGHUA MANSIN TONGLE XINBU VILLANG TOWN SHENZHEN CITY CHINA

Sample Name : Gold (AU)

The above sample(s) and information were provided by the client.

SGS Job No. : CP22-047169 - SZ
 Date of Sample Received : 25 Aug 2022
 Testing Period : 25 Aug 2022 - 30 Aug 2022
 Test Requested : Selected test(s) as requested by the client.
 Test Method(s) : Please refer to next page(s).
 Test Result(s) : Please refer to next page(s).

Result Summary :

| Test Requested | Conclusion |
|--|-------------|
| EU RoHS Directive (EU) 2015/863 amending Annex II to Directive 2011/65/EU- Lead, Mercury, Cadmium, Hexavalent chromium, Polybrominated biphenyls (PBBs), Polybrominated diphenyl ethers (PBDEs), Bis(2-ethylhexyl) phthalate (DEHP), Butyl benzyl phthalate (BBP), Dibutyl phthalate (DBP) and Diisobutyl phthalate (DIBP) | PASS |
| Perfluorooctanoic acid (PFOA) and its salts & Perfluorooctane sulfonates (PFOS) and its derivatives | See Results |

Signed for and on behalf of
 SGS-CSTC Standards Technical Services Co., Ltd. Guangzhou Branch

Dongyu Xie

Dongyu Xie
 Approved Signatory

scan to see the report



9B230D54



Unless otherwise agreed in writing, this document is issued by the Company subject to its General Conditions of Service printed overleaf, available on request or accessible at <http://www.sgs.com/en/Terms-and-Conditions.aspx> and, for electronic format documents, subject to Terms and Conditions for Electronic Documents at <http://www.sgs.com/en/Terms-and-Conditions/Terms-e-Documents.aspx>. Attention is drawn to the limitation of liability, indemnification and jurisdiction issues defined therein. Any holder of this document is advised that information contained hereon reflects the Company's findings at the time of its intervention only and within the limits of Client's instructions, if any. The Company's sole responsibility is to its Client and this document does not exonerate parties to a transaction from exercising all their rights and obligations under the transaction documents. This document cannot be reproduced except in full, without prior written approval of the Company. Any unauthorized alteration, forgery or falsification of the content or appearance of this document is unlawful and offenders may be prosecuted to the fullest extent of the law. Unless otherwise stated the results shown in this test report refer only to the sample(s) tested.

Attention: To check the authenticity of testing / inspection report & certificate, please contact us at telephone: (86-755) 8307 1443, or email: CN.Doccheck@sgs.com

Test Report

No. CANEC2218227002

Date: 30 Aug 2022

Page 2 of 8

Test Result(s) :

Test Part Description :

| Specimen No. | SGS Sample ID | Description |
|--------------|------------------|-------------------|
| SN1 | CAN22-182270.002 | Gold plated metal |

Remarks :

- (1) 1 mg/kg = 0.0001%
- (2) MDL = Method Detection Limit
- (3) ND = Not Detected (< MDL)
- (4) "-" = Not Regulated

EU RoHS Directive (EU) 2015/863 amending Annex II to Directive 2011/65/EU- Lead, Mercury, Cadmium, Hexavalent chromium, Polybrominated biphenyls (PBBs), Polybrominated diphenyl ethers (PBDEs), Bis(2-ethylhexyl) phthalate (DEHP), Butyl benzyl phthalate (BBP), Dibutyl phthalate (DBP) and Diisobutyl phthalate (DIBP)

Test Method : With reference to IEC 62321-4:2013+A1:2017, IEC 62321-5:2013, IEC 62321-7-1:2015 , IEC 62321-6:2015 and IEC 62321-8:2017, analyzed by ICP-OES , UV-Vis and GC-MS .

| Test Item(s) | Limit | Unit | MDL | 002 |
|-------------------------------|-------|--------------------|------|-----|
| Cadmium (Cd) | 100 | mg/kg | 2 | ND |
| Lead (Pb) | 1000 | mg/kg | 2 | 50 |
| Mercury (Hg) | 1000 | mg/kg | 2 | ND |
| Hexavalent Chromium (Cr(VI))▼ | - | µg/cm ² | 0.10 | ND |
| Sum of PBBs | 1000 | mg/kg | - | ND |
| Monobromobiphenyl | - | mg/kg | 5 | ND |
| Dibromobiphenyl | - | mg/kg | 5 | ND |
| Tribromobiphenyl | - | mg/kg | 5 | ND |
| Tetrabromobiphenyl | - | mg/kg | 5 | ND |
| Pentabromobiphenyl | - | mg/kg | 5 | ND |
| Hexabromobiphenyl | - | mg/kg | 5 | ND |
| Heptabromobiphenyl | - | mg/kg | 5 | ND |
| Octabromobiphenyl | - | mg/kg | 5 | ND |
| Nonabromobiphenyl | - | mg/kg | 5 | ND |
| Decabromobiphenyl | - | mg/kg | 5 | ND |
| Sum of PBDEs | 1000 | mg/kg | - | ND |
| Monobromodiphenyl ether | - | mg/kg | 5 | ND |
| Dibromodiphenyl ether | - | mg/kg | 5 | ND |
| Tribromodiphenyl ether | - | mg/kg | 5 | ND |
| Tetrabromodiphenyl ether | - | mg/kg | 5 | ND |



Unless otherwise agreed in writing, this document is issued by the Company subject to its General Conditions of Service printed overleaf, available on request or accessible at <http://www.sgs.com/en/Terms-and-Conditions.aspx> and, for electronic format documents, subject to Terms and Conditions for Electronic Documents at <http://www.sgs.com/en/Terms-and-Conditions/Terms-e-Document.aspx>. Attention is drawn to the limitation of liability, indemnification and jurisdiction issues defined therein. Any holder of this document is advised that information contained hereon reflects the Company's findings at the time of its intervention only and within the limits of Client's instructions, if any. The Company's sole responsibility is to its Client and this document does not exonerate parties to a transaction from exercising all their rights and obligations under the transaction documents. This document cannot be reproduced except in full, without prior written approval of the Company. Any unauthorized alteration, forgery or falsification of the content or appearance of this document is unlawful and offenders may be prosecuted to the fullest extent of the law. Unless otherwise stated the results shown in this test report refer only to the sample(s) tested.

Attention: To check the authenticity of testing /inspection report & certificate, please contact us at telephone: (86-755) 8307 1443, or email: CN.Doccheck@sgs.com

Test Report

No. CANEC2218227002

Date: 30 Aug 2022

Page 3 of 8

| <u>Test Item(s)</u> | <u>Limit</u> | <u>Unit</u> | <u>MDL</u> | <u>002</u> |
|-------------------------------------|--------------|-------------|------------|------------|
| Pentabromodiphenyl ether | - | mg/kg | 5 | ND |
| Hexabromodiphenyl ether | - | mg/kg | 5 | ND |
| Heptabromodiphenyl ether | - | mg/kg | 5 | ND |
| Octabromodiphenyl ether | - | mg/kg | 5 | ND |
| Nonabromodiphenyl ether | - | mg/kg | 5 | ND |
| Decabromodiphenyl ether | - | mg/kg | 5 | ND |
| Dibutyl phthalate (DBP) | 1000 | mg/kg | 50 | ND |
| Butyl benzyl phthalate (BBP) | 1000 | mg/kg | 50 | ND |
| Bis (2-ethylhexyl) phthalate (DEHP) | 1000 | mg/kg | 50 | ND |
| Diisobutyl Phthalates (DIBP) | 1000 | mg/kg | 50 | ND |

Notes :

- (1) The maximum permissible limit is quoted from RoHS Directive (EU) 2015/863.
 - (2) IEC 62321 series is equivalent to EN 62321 series
 - (3) ▼= a. The sample is positive for CrVI if the CrVI concentration is greater than 0.13 µg/cm². The sample coating is considered to contain CrVI
 b. The sample is negative for CrVI if CrVI is ND (concentration less than 0.10 µg/cm²). The coating is considered a non-CrVI based coating
 c. The result between 0.10 µg/cm² and 0.13 µg/cm² is considered to be inconclusive - unavoidable coating variations may influence the determination
- Information on storage conditions and production date of the tested sample is unavailable and thus Cr(VI) results represent status of the sample at the time of testing.

Perfluorooctanoic acid (PFOA) and its salts & Perfluorooctane sulfonates (PFOS) and its derivatives

Test Method : With reference to CEN/TS15968:2010, analysis was performed by LC-MS or LC-MS/MS.

| <u>Test Item(s)</u> | <u>CAS NO.</u> | <u>Unit</u> | <u>MDL</u> | <u>002</u> |
|---|----------------|-------------|------------|------------|
| Perfluorooctanoic acid (PFOA) and its salts+ | 335-67-1 | mg/kg | 0.010 | ND |
| Perfluorooctane sulfonates (PFOS) ^ | 1763-23-1 | mg/kg | 0.010 | ND |
| Perfluorooctane Sulfonamide (PFOSA) | 754-91-6 | mg/kg | 0.010 | ND |
| N-methylperfluoro-1-octanesulfonamide(MeFOSA) | 31506-32-8 | mg/kg | 0.010 | ND |
| N-ethylperfluoro-1-octanesulfonamide (EtFOSA) | 4151-50-2 | mg/kg | 0.010 | ND |
| 2-(N-methylperfluoro-1-octanesulfonamido)-ethanol(MeFOSE) | 24448-09-7 | mg/kg | 0.010 | ND |
| 2-(N-ethylperfluoro-1-octanesulfonamido)-ethanol(EtFOSE) | 1691-99-2 | mg/kg | 0.010 | ND |
| Perfluorooctane sulfonates (PFOS) and its derivatives | - | mg/kg | - | ND |

Notes :



Unless otherwise agreed in writing, this document is issued by the Company subject to its General Conditions of Service printed overleaf, available on request or accessible at <http://www.sgs.com/en/Terms-and-Conditions.aspx> and, for electronic format documents, subject to Terms and Conditions for Electronic Documents at <http://www.sgs.com/en/Terms-and-Conditions/Terms-e-Document.aspx>. Attention is drawn to the limitation of liability, indemnification and jurisdiction issues defined therein. Any holder of this document is advised that information contained hereon reflects the Company's findings at the time of its intervention only and within the limits of Client's instructions, if any. The Company's sole responsibility is to its Client and this document does not exonerate parties to a transaction from exercising all their rights and obligations under the transaction documents. This document cannot be reproduced except in full, without prior written approval of the Company. Any unauthorized alteration, forgery or falsification of the content or appearance of this document is unlawful and offenders may be prosecuted to the fullest extent of the law. Unless otherwise stated the results shown in this test report refer only to the sample(s) tested.

- (1) + PFOA and its salts including PFOA-Na (CAS No.: 335-95-5), PFOA-K (CAS No.: 2395-00-8), PFOA-Ag (CAS No.: 335-93-3), PFOA-F (CAS No.: 335-66-0) and APFO (CAS No.: 3825-26-1);
- (2) ^ PFOS including PFOS-K (CAS No.: 2795-39-3), PFOS-Li (CAS No.: 29457-72-5), PFOS-NH₄ (CAS No.: 29081-56-9), PFOS-NH(OH)₂ (CAS No.: 70225-14-8), PFOS-N(C₂H₅)₄ (CAS No.: 56773-42-3), PFOS-DDA (CAS No.: 251099-16-8) and POSF (CAS No.: 307-35-7)

Unless otherwise stated, the decision rule for conformity reporting is based on Binary Statement for Simple Acceptance Rule ($w=0$) stated in ILAC-G8:09/2019.



Unless otherwise agreed in writing, this document is issued by the Company subject to its General Conditions of Service printed overleaf, available on request or accessible at <http://www.sgs.com/en/Terms-and-Conditions.aspx> and, for electronic format documents, subject to Terms and Conditions for Electronic Documents at <http://www.sgs.com/en/Terms-and-Conditions/Terms-e-Documents.aspx>. Attention is drawn to the limitation of liability, indemnification and jurisdiction issues defined therein. Any holder of this document is advised that information contained hereon reflects the Company's findings at the time of its intervention only and within the limits of Client's instructions, if any. The Company's sole responsibility is to its Client and this document does not exonerate parties to a transaction from exercising all their rights and obligations under the transaction documents. This document cannot be reproduced except in full, without prior written approval of the Company. Any unauthorized alteration, forgery or falsification of the content or appearance of this document is unlawful and offenders may be prosecuted to the fullest extent of the law. Unless otherwise stated the results shown in this test report refer only to the sample(s) tested.

Attention: To check the authenticity of testing / inspection report & certificate, please contact us at telephone: (86-755) 8307 1443, or email: CN.Doccheck@sgs.com

ATTACHMENTS

Pb/Cd/Hg/Cr⁶⁺/PBBs/PBDEs Testing Flow Chart

1) These samples were dissolved totally by pre-conditioning method according to below flow chart. (Cr⁶⁺ and PBBs/PBDEs test method excluded).

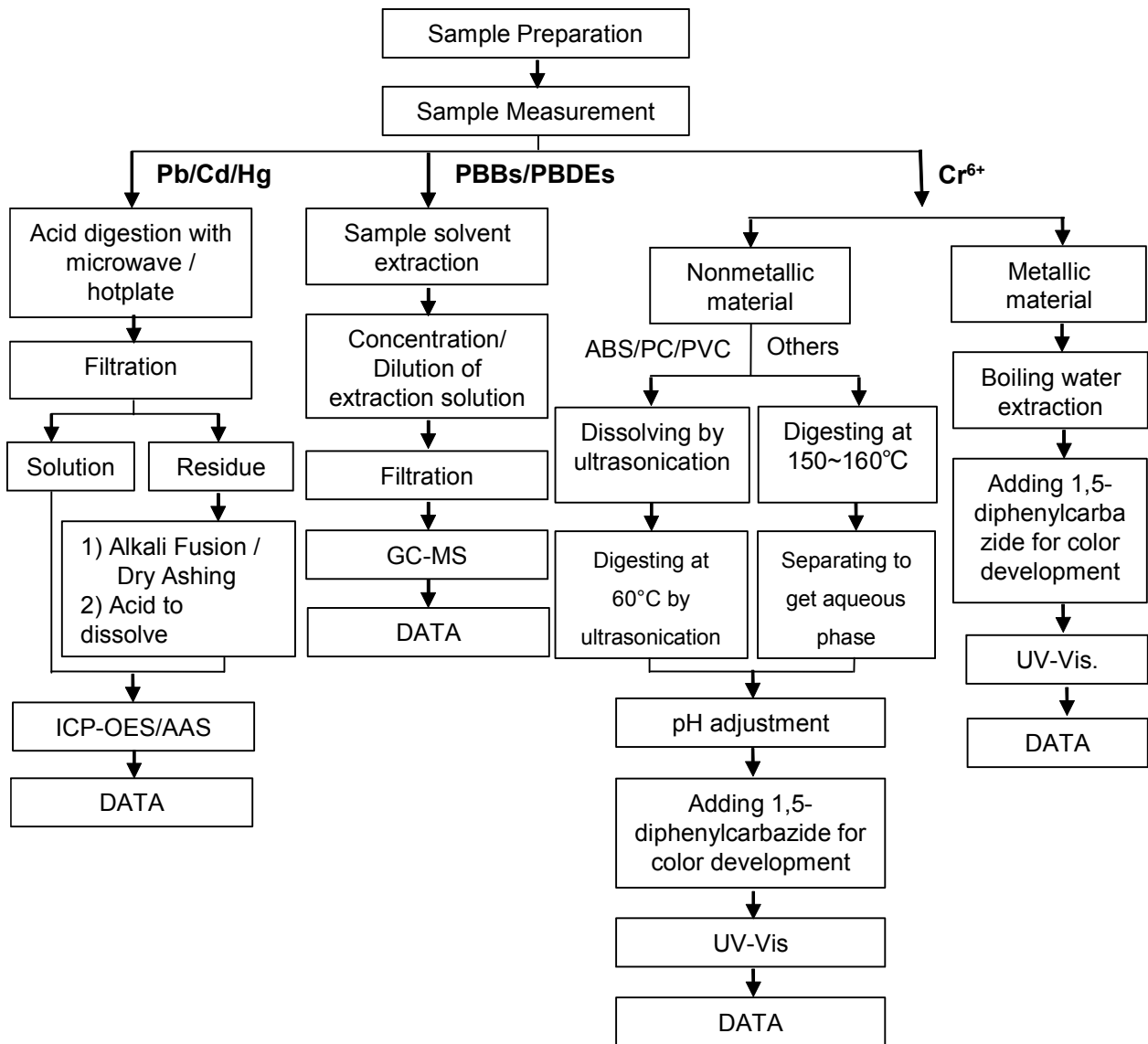

ATTACHMENTS

Phthalates Testing Flow Chart

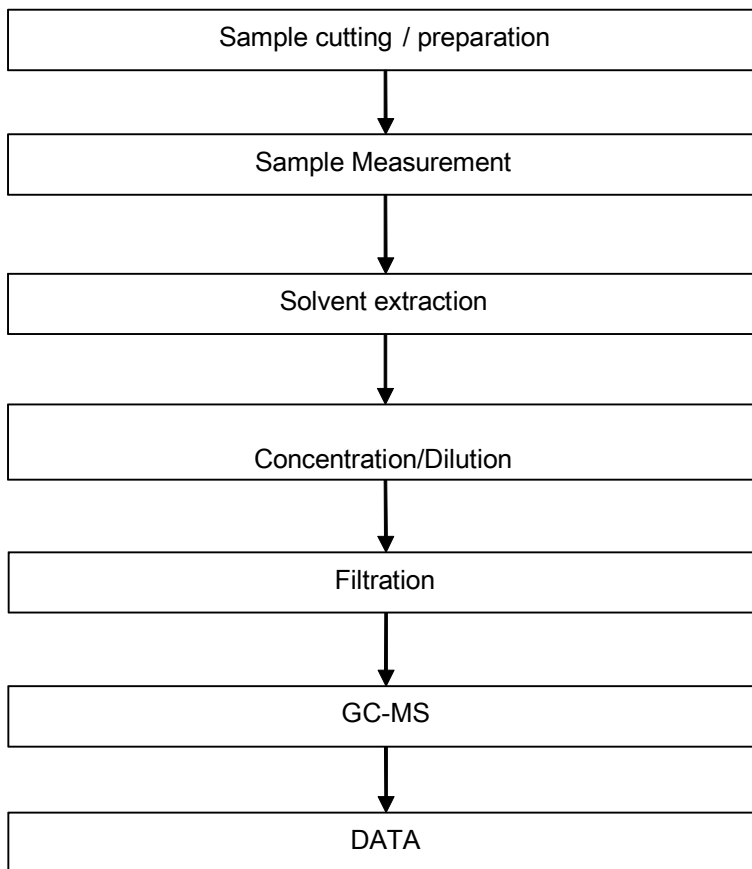

ATTACHMENTS

PFOA / PFOS Testing Flow Chart

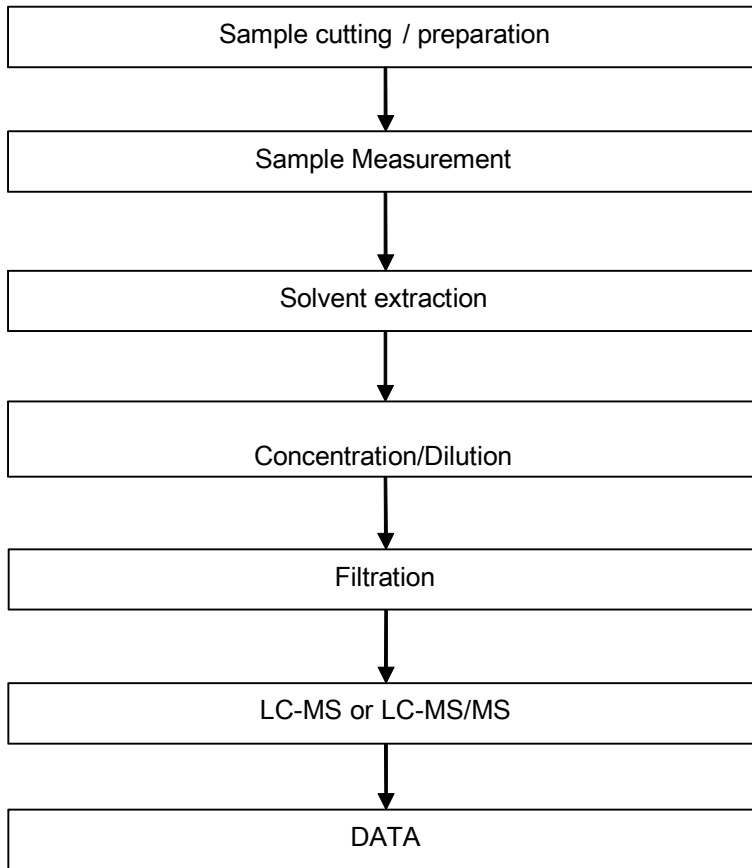

Unless otherwise agreed in writing, this document is issued by the Company subject to its General Conditions of Service printed overleaf, available on request or accessible at <http://www.sgs.com/en/Terms-and-Conditions.aspx> and, for electronic format documents, subject to Terms and Conditions for Electronic Documents at <http://www.sgs.com/en/Terms-and-Conditions/Terms-e-Document.aspx>. Attention is drawn to the limitation of liability, indemnification and jurisdiction issues defined therein. Any holder of this document is advised that information contained hereon reflects the Company's findings at the time of its intervention only and within the limits of Client's instructions, if any. The Company's sole responsibility is to its Client and this document does not exonerate parties to a transaction from exercising all their rights and obligations under the transaction documents. This document cannot be reproduced except in full, without prior written approval of the Company. Any unauthorized alteration, forgery or falsification of the content or appearance of this document is unlawful and offenders may be prosecuted to the fullest extent of the law. Unless otherwise stated the results shown in this test report refer only to the sample(s) tested.

Attention: To check the authenticity of testing / inspection report & certificate, please contact us at telephone: (86-755) 8307 1443, or email: CN.Doccheck@sgs.com

Sample photo:



SGS authenticate the photo on original report only

*** End of Report ***



Test Report

No. CANEC2218227001

Date: 30 Aug 2022

Page 1 of 8

Client Name : SHENZHEN CITY TONGHUA INDUSTRY CO.,LTD

Client Address : TONGHUA MANSIN TONGLE XINBU VILLANG TOWN SHENZHEN CITY CHINA

Sample Name : Nickel(Ni)

The above sample(s) and information were provided by the client.

SGS Job No. : CP22-047169 - SZ
 Date of Sample Received : 25 Aug 2022
 Testing Period : 25 Aug 2022 - 30 Aug 2022
 Test Requested : Selected test(s) as requested by the client.
 Test Method(s) : Please refer to next page(s).
 Test Result(s) : Please refer to next page(s).

Result Summary :

| Test Requested | Conclusion |
|--|-------------|
| EU RoHS Directive (EU) 2015/863 amending Annex II to Directive 2011/65/EU- Lead, Mercury, Cadmium, Hexavalent chromium, Polybrominated biphenyls (PBBs), Polybrominated diphenyl ethers (PBDEs), Bis(2-ethylhexyl) phthalate (DEHP), Butyl benzyl phthalate (BBP), Dibutyl phthalate (DBP) and Diisobutyl phthalate (DIBP) | PASS |
| Perfluorooctanoic acid (PFOA) and its salts & Perfluorooctane sulfonates (PFOS) and its derivatives | See Results |

Signed for and on behalf of
 SGS-CSTC Standards Technical Services Co., Ltd. Guangzhou Branch

Dongyu Xie

Dongyu Xie
 Approved Signatory

scan to see the report



5753937E



Unless otherwise agreed in writing, this document is issued by the Company subject to its General Conditions of Service printed overleaf, available on request or accessible at <http://www.sgs.com/en/Terms-and-Conditions.aspx> and, for electronic format documents, subject to Terms and Conditions for Electronic Documents at <http://www.sgs.com/en/Terms-and-Conditions/Terms-e-Document.aspx>. Attention is drawn to the limitation of liability, indemnification and jurisdiction issues defined therein. Any holder of this document is advised that information contained hereon reflects the Company's findings at the time of its intervention only and within the limits of Client's instructions, if any. The Company's sole responsibility is to its Client and this document does not exonerate parties to a transaction from exercising all their rights and obligations under the transaction documents. This document cannot be reproduced except in full, without prior written approval of the Company. Any unauthorized alteration, forgery or falsification of the content or appearance of this document is unlawful and offenders may be prosecuted to the fullest extent of the law. Unless otherwise stated the results shown in this test report refer only to the sample(s) tested.

Attention: To check the authenticity of testing /inspection report & certificate, please contact us at telephone: (86-755) 8307 1443, or email: CN.Doccheck@sgs.com

Test Report

No. CANEC2218227001

Date: 30 Aug 2022

Page 2 of 8

Test Result(s) :

Test Part Description :

| Specimen No. | SGS Sample ID | Description |
|--------------|------------------|--------------------------|
| SN1 | CAN22-182270.001 | Silver-gray plated metal |

Remarks :

- (1) 1 mg/kg = 0.0001%
- (2) MDL = Method Detection Limit
- (3) ND = Not Detected (< MDL)
- (4) "-" = Not Regulated

EU RoHS Directive (EU) 2015/863 amending Annex II to Directive 2011/65/EU- Lead, Mercury, Cadmium, Hexavalent chromium, Polybrominated biphenyls (PBBs), Polybrominated diphenyl ethers (PBDEs), Bis(2-ethylhexyl) phthalate (DEHP), Butyl benzyl phthalate (BBP), Dibutyl phthalate (DBP) and Diisobutyl phthalate (DIBP)

Test Method : With reference to IEC 62321-4:2013+A1:2017, IEC 62321-5:2013, IEC 62321-7-1:2015 , IEC 62321-6:2015 and IEC 62321-8:2017, analyzed by ICP-OES , UV-Vis and GC-MS .

| Test Item(s) | Limit | Unit | MDL | 001 |
|-------------------------------|-------|--------------------|------|-----|
| Cadmium (Cd) | 100 | mg/kg | 2 | ND |
| Lead (Pb) | 1000 | mg/kg | 2 | 49 |
| Mercury (Hg) | 1000 | mg/kg | 2 | ND |
| Hexavalent Chromium (Cr(VI))▼ | - | µg/cm ² | 0.10 | ND |
| Sum of PBBs | 1000 | mg/kg | - | ND |
| Monobromobiphenyl | - | mg/kg | 5 | ND |
| Dibromobiphenyl | - | mg/kg | 5 | ND |
| Tribromobiphenyl | - | mg/kg | 5 | ND |
| Tetrabromobiphenyl | - | mg/kg | 5 | ND |
| Pentabromobiphenyl | - | mg/kg | 5 | ND |
| Hexabromobiphenyl | - | mg/kg | 5 | ND |
| Heptabromobiphenyl | - | mg/kg | 5 | ND |
| Octabromobiphenyl | - | mg/kg | 5 | ND |
| Nonabromobiphenyl | - | mg/kg | 5 | ND |
| Decabromobiphenyl | - | mg/kg | 5 | ND |
| Sum of PBDEs | 1000 | mg/kg | - | ND |
| Monobromodiphenyl ether | - | mg/kg | 5 | ND |
| Dibromodiphenyl ether | - | mg/kg | 5 | ND |
| Tribromodiphenyl ether | - | mg/kg | 5 | ND |
| Tetrabromodiphenyl ether | - | mg/kg | 5 | ND |



Unless otherwise agreed in writing, this document is issued by the Company subject to its General Conditions of Service printed overleaf, available on request or accessible at <http://www.sgs.com/en/Terms-and-Conditions.aspx> and, for electronic format documents, subject to Terms and Conditions for Electronic Documents at <http://www.sgs.com/en/Terms-and-Conditions/Terms-e-Documents.aspx>. Attention is drawn to the limitation of liability, indemnification and jurisdiction issues defined therein. Any holder of this document is advised that information contained hereon reflects the Company's findings at the time of its intervention only and within the limits of Client's instructions, if any. The Company's sole responsibility is to its Client and this document does not exonerate parties to a transaction from exercising all their rights and obligations under the transaction documents. This document cannot be reproduced except in full, without prior written approval of the Company. Any unauthorized alteration, forgery or falsification of the content or appearance of this document is unlawful and offenders may be prosecuted to the fullest extent of the law. Unless otherwise stated the results shown in this test report refer only to the sample(s) tested.

Attention: To check the authenticity of testing /inspection report & certificate, please contact us at telephone: (86-755) 8307 1443, or email: CN.Doccheck@sgs.com

Test Report

No. CANEC2218227001

Date: 30 Aug 2022

Page 3 of 8

| <u>Test Item(s)</u> | <u>Limit</u> | <u>Unit</u> | <u>MDL</u> | <u>001</u> |
|-------------------------------------|--------------|-------------|------------|------------|
| Pentabromodiphenyl ether | - | mg/kg | 5 | ND |
| Hexabromodiphenyl ether | - | mg/kg | 5 | ND |
| Heptabromodiphenyl ether | - | mg/kg | 5 | ND |
| Octabromodiphenyl ether | - | mg/kg | 5 | ND |
| Nonabromodiphenyl ether | - | mg/kg | 5 | ND |
| Decabromodiphenyl ether | - | mg/kg | 5 | ND |
| Dibutyl phthalate (DBP) | 1000 | mg/kg | 50 | ND |
| Butyl benzyl phthalate (BBP) | 1000 | mg/kg | 50 | ND |
| Bis (2-ethylhexyl) phthalate (DEHP) | 1000 | mg/kg | 50 | ND |
| Diisobutyl Phthalates (DIBP) | 1000 | mg/kg | 50 | ND |

Notes :

- (1) The maximum permissible limit is quoted from RoHS Directive (EU) 2015/863.
- (2) IEC 62321 series is equivalent to EN 62321 series
- (3) ▼= a. The sample is positive for CrVI if the CrVI concentration is greater than 0.13 µg/cm². The sample coating is considered to contain CrVI
 b. The sample is negative for CrVI if CrVI is ND (concentration less than 0.10 µg/cm²). The coating is considered a non-CrVI based coating
 c. The result between 0.10 µg/cm² and 0.13 µg/cm² is considered to be inconclusive - unavoidable coating variations may influence the determination
 Information on storage conditions and production date of the tested sample is unavailable and thus Cr(VI) results represent status of the sample at the time of testing.

Perfluorooctanoic acid (PFOA) and its salts & Perfluorooctane sulfonates (PFOS) and its derivatives

Test Method : With reference to CEN/TS15968:2010, analysis was performed by LC-MS or LC-MS/MS.

| <u>Test Item(s)</u> | <u>CAS NO.</u> | <u>Unit</u> | <u>MDL</u> | <u>001</u> |
|---|----------------|-------------|------------|------------|
| Perfluorooctanoic acid (PFOA) and its salts+ | 335-67-1 | mg/kg | 0.010 | ND |
| Perfluorooctane sulfonates (PFOS) ^ | 1763-23-1 | mg/kg | 0.010 | ND |
| Perfluorooctane Sulfonamide (PFOSA) | 754-91-6 | mg/kg | 0.010 | ND |
| N-methylperfluoro-1-octanesulfonamide(MeFOSA) | 31506-32-8 | mg/kg | 0.010 | ND |
| N-ethylperfluoro-1-octanesulfonamide (EtFOSA) | 4151-50-2 | mg/kg | 0.010 | ND |
| 2-(N-methylperfluoro-1-octanesulfonamido)-ethanol(MeFOSE) | 24448-09-7 | mg/kg | 0.010 | ND |
| 2-(N-ethylperfluoro-1-octanesulfonamido)-ethanol(EtFOSE) | 1691-99-2 | mg/kg | 0.010 | ND |
| Perfluorooctane sulfonates (PFOS) and its derivatives | - | mg/kg | - | ND |

Notes :



Unless otherwise agreed in writing, this document is issued by the Company subject to its General Conditions of Service printed overleaf, available on request or accessible at <http://www.sgs.com/en/Terms-and-Conditions.aspx> and, for electronic format documents, subject to Terms and Conditions for Electronic Documents at <http://www.sgs.com/en/Terms-and-Conditions/Terms-e-Documents.aspx>. Attention is drawn to the limitation of liability, indemnification and jurisdiction issues defined therein. Any holder of this document is advised that information contained hereon reflects the Company's findings at the time of its intervention only and within the limits of Client's instructions, if any. The Company's sole responsibility is to its Client and this document does not exonerate parties to a transaction from exercising all their rights and obligations under the transaction documents. This document cannot be reproduced except in full, without prior written approval of the Company. Any unauthorized alteration, forgery or falsification of the content or appearance of this document is unlawful and offenders may be prosecuted to the fullest extent of the law. Unless otherwise stated the results shown in this test report refer only to the sample(s) tested.

- (1) + PFOA and its salts including PFOA-Na (CAS No.: 335-95-5), PFOA-K (CAS No.: 2395-00-8), PFOA-Ag (CAS No.: 335-93-3), PFOA-F (CAS No.: 335-66-0) and APFO (CAS No.: 3825-26-1);
 (2) ^ PFOS including PFOS-K (CAS No.: 2795-39-3), PFOS-Li (CAS No.: 29457-72-5), PFOS-NH₄ (CAS No.: 29081-56-9), PFOS-NH(OH)₂ (CAS No.: 70225-14-8), PFOS-N(C₂H₅)₄ (CAS No.: 56773-42-3), PFOS-DDA(CAS No.:251099-16-8) and POSF (CAS No.: 307-35-7)

Unless otherwise stated, the decision rule for conformity reporting is based on Binary Statement for Simple Acceptance Rule ($w=0$) stated in ILAC-G8:09/2019.



Unless otherwise agreed in writing, this document is issued by the Company subject to its General Conditions of Service printed overleaf, available on request or accessible at <http://www.sgs.com/en/Terms-and-Conditions.aspx> and, for electronic format documents, subject to Terms and Conditions for Electronic Documents at <http://www.sgs.com/en/Terms-and-Conditions/Terms-e-Documents.aspx>. Attention is drawn to the limitation of liability, indemnification and jurisdiction issues defined therein. Any holder of this document is advised that information contained hereon reflects the Company's findings at the time of its intervention only and within the limits of Client's instructions, if any. The Company's sole responsibility is to its Client and this document does not exonerate parties to a transaction from exercising all their rights and obligations under the transaction documents. This document cannot be reproduced except in full, without prior written approval of the Company. Any unauthorized alteration, forgery or falsification of the content or appearance of this document is unlawful and offenders may be prosecuted to the fullest extent of the law. Unless otherwise stated the results shown in this test report refer only to the sample(s) tested.

Attention: To check the authenticity of testing /inspection report & certificate, please contact us at telephone: (86-755) 8307 1443, or email: CN.Doccheck@sgs.com

ATTACHMENTS

Pb/Cd/Hg/Cr⁶⁺/PBBs/PBDEs Testing Flow Chart

1) These samples were dissolved totally by pre-conditioning method according to below flow chart. (Cr⁶⁺ and PBBs/PBDEs test method excluded).

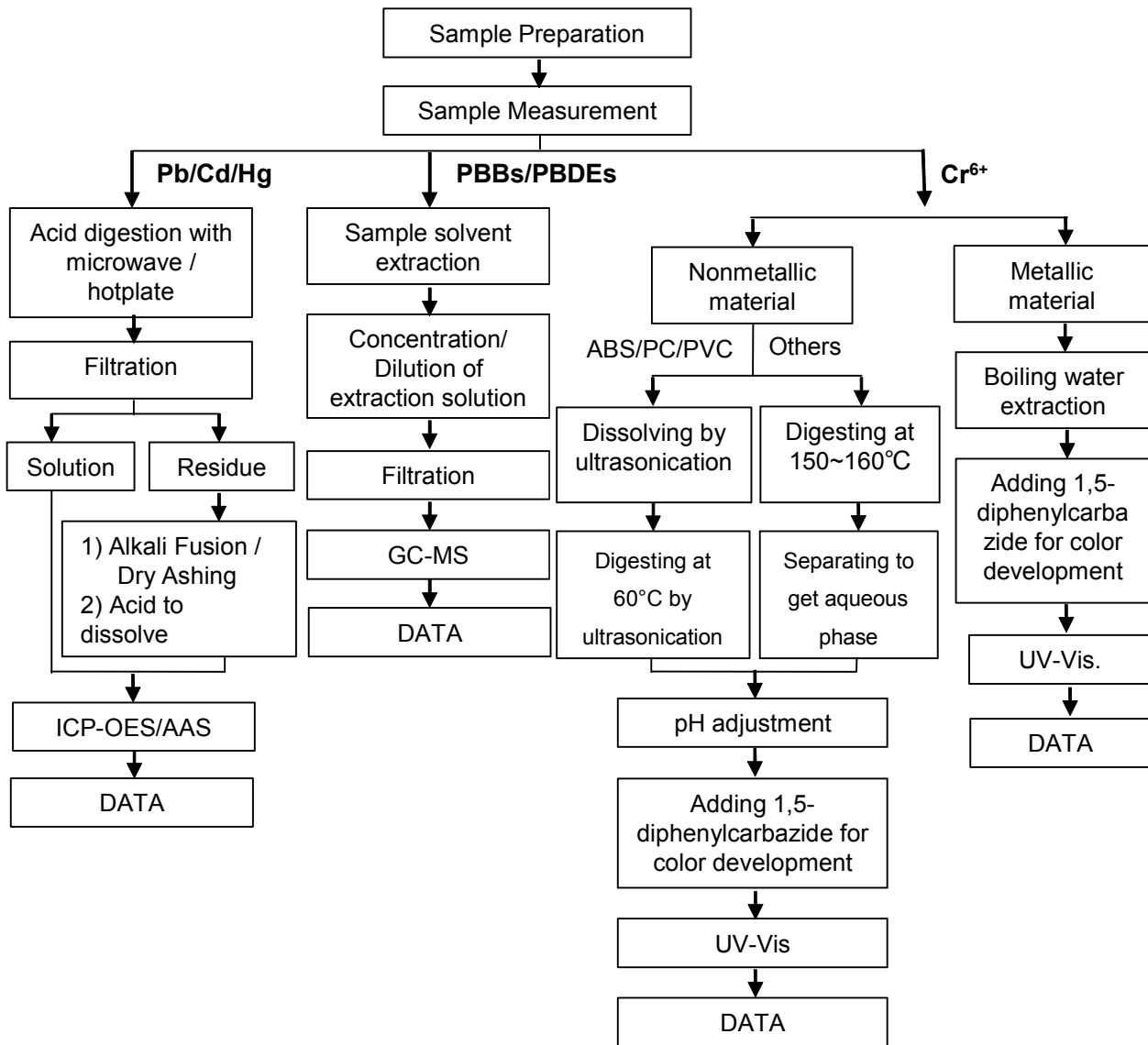

ATTACHMENTS

Phthalates Testing Flow Chart

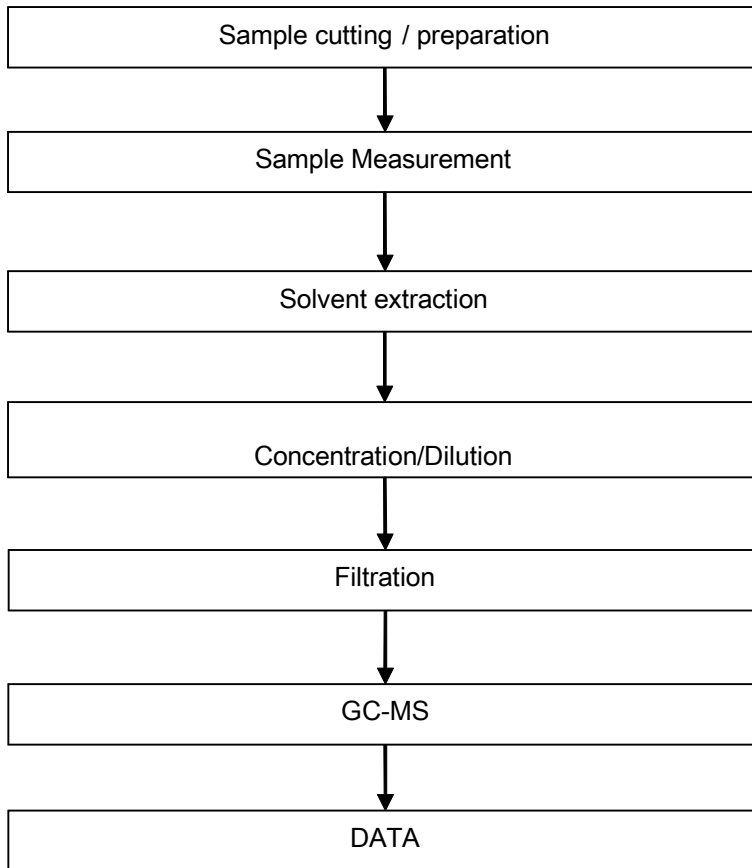

Unless otherwise agreed in writing, this document is issued by the Company subject to its General Conditions of Service printed overleaf, available on request or accessible at <http://www.sgs.com/en/Terms-and-Conditions.aspx> and, for electronic format documents, subject to Terms and Conditions for Electronic Documents at <http://www.sgs.com/en/Terms-and-Conditions/Terms-e-Document.aspx>. Attention is drawn to the limitation of liability, indemnification and jurisdiction issues defined therein. Any holder of this document is advised that information contained hereon reflects the Company's findings at the time of its intervention only and within the limits of Client's instructions, if any. The Company's sole responsibility is to its Client and this document does not exonerate parties to a transaction from exercising all their rights and obligations under the transaction documents. This document cannot be reproduced except in full, without prior written approval of the Company. Any unauthorized alteration, forgery or falsification of the content or appearance of this document is unlawful and offenders may be prosecuted to the fullest extent of the law. Unless otherwise stated the results shown in this test report refer only to the sample(s) tested.

Attention: To check the authenticity of testing / inspection report & certificate, please contact us at telephone: (86-755) 8307 1443, or email: CN.Doccheck@sgs.com

ATTACHMENTS

PFOA / PFOS Testing Flow Chart

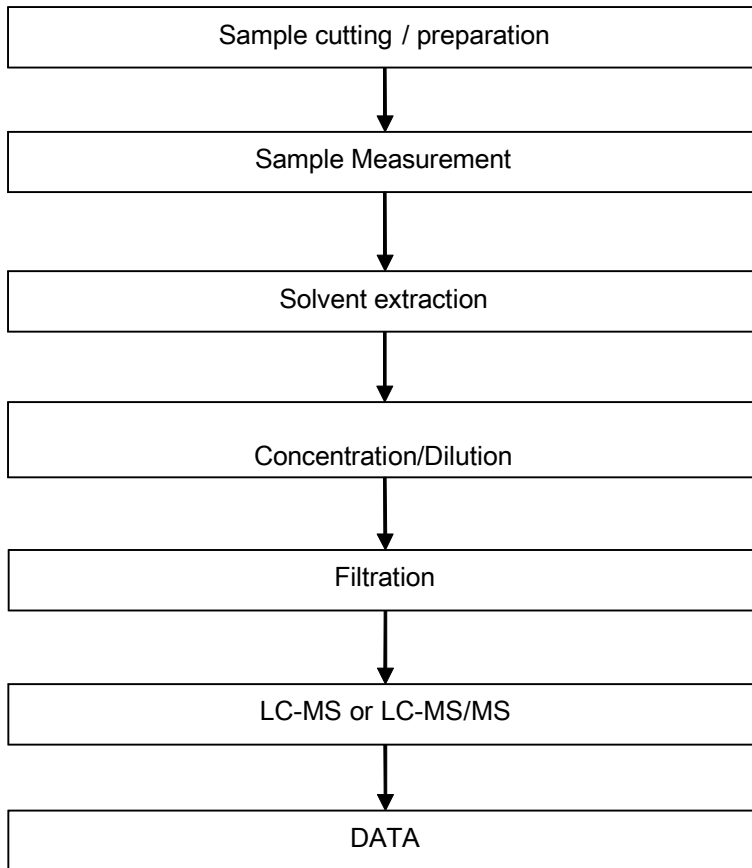

Unless otherwise agreed in writing, this document is issued by the Company subject to its General Conditions of Service printed overleaf, available on request or accessible at <http://www.sgs.com/en/Terms-and-Conditions.aspx> and, for electronic format documents, subject to Terms and Conditions for Electronic Documents at <http://www.sgs.com/en/Terms-and-Conditions/Terms-e-Document.aspx>. Attention is drawn to the limitation of liability, indemnification and jurisdiction issues defined therein. Any holder of this document is advised that information contained hereon reflects the Company's findings at the time of its intervention only and within the limits of Client's instructions, if any. The Company's sole responsibility is to its Client and this document does not exonerate parties to a transaction from exercising all their rights and obligations under the transaction documents. This document cannot be reproduced except in full, without prior written approval of the Company. Any unauthorized alteration, forgery or falsification of the content or appearance of this document is unlawful and offenders may be prosecuted to the fullest extent of the law. Unless otherwise stated the results shown in this test report refer only to the sample(s) tested.

Attention: To check the authenticity of testing / inspection report & certificate, please contact us at telephone: (86-755) 8307 1443, or email: CN.Doccheck@sgs.com

Sample photo:



SGS authenticate the photo on original report only

*** End of Report ***



Test Report

No. CANEC2218227003

Date: 30 Aug 2022

Page 1 of 8

Client Name : SHENZHEN CITY TONGHUA INDUSTRY CO.,LTD

Client Address : TONGHUA MANSIN TONGLE XINBU VILLANG TOWN SHENZHEN CITY CHINA

Sample Name : Bright Tin(SN)

The above sample(s) and information were provided by the client.

SGS Job No. : CP22-047169 - SZ
 Date of Sample Received : 25 Aug 2022
 Testing Period : 25 Aug 2022 - 30 Aug 2022
 Test Requested : Selected test(s) as requested by the client.
 Test Method(s) : Please refer to next page(s).
 Test Result(s) : Please refer to next page(s).

Result Summary :

| Test Requested | Conclusion |
|--|-------------|
| EU RoHS Directive (EU) 2015/863 amending Annex II to Directive 2011/65/EU- Lead, Mercury, Cadmium, Hexavalent chromium, Polybrominated biphenyls (PBBs), Polybrominated diphenyl ethers (PBDEs), Bis(2-ethylhexyl) phthalate (DEHP), Butyl benzyl phthalate (BBP), Dibutyl phthalate (DBP) and Diisobutyl phthalate (DIBP) | PASS |
| Perfluorooctanoic acid (PFOA) and its salts & Perfluorooctane sulfonates (PFOS) and its derivatives | See Results |

Signed for and on behalf of
 SGS-CSTC Standards Technical Services Co., Ltd. Guangzhou Branch

Dongyu Xie

Dongyu Xie
 Approved Signatory

scan to see the report



87F8007D



Unless otherwise agreed in writing, this document is issued by the Company subject to its General Conditions of Service printed overleaf, available on request or accessible at <http://www.sgs.com/en/Terms-and-Conditions.aspx> and, for electronic format documents, subject to Terms and Conditions for Electronic Documents at <http://www.sgs.com/en/Terms-and-Conditions/Terms-e-Documents.aspx>. Attention is drawn to the limitation of liability, indemnification and jurisdiction issues defined therein. Any holder of this document is advised that information contained hereon reflects the Company's findings at the time of its intervention only and within the limits of Client's instructions, if any. The Company's sole responsibility is to its Client and this document does not exonerate parties to a transaction from exercising all their rights and obligations under the transaction documents. This document cannot be reproduced except in full, without prior written approval of the Company. Any unauthorized alteration, forgery or falsification of the content or appearance of this document is unlawful and offenders may be prosecuted to the fullest extent of the law. Unless otherwise stated the results shown in this test report refer only to the sample(s) tested.

Attention: To check the authenticity of testing / inspection report & certificate, please contact us at telephone: (86-755) 8307 1443, or email: CN.Doccheck@sgs.com

Test Report

No. CANEC2218227003

Date: 30 Aug 2022

Page 2 of 8

Test Result(s) :

Test Part Description :

| Specimen No. | SGS Sample ID | Description |
|--------------|------------------|--------------------------|
| SN1 | CAN22-182270.003 | Silver-gray plated metal |

Remarks :

- (1) 1 mg/kg = 0.0001%
- (2) MDL = Method Detection Limit
- (3) ND = Not Detected (< MDL)
- (4) "-" = Not Regulated

EU RoHS Directive (EU) 2015/863 amending Annex II to Directive 2011/65/EU- Lead, Mercury, Cadmium, Hexavalent chromium, Polybrominated biphenyls (PBBs), Polybrominated diphenyl ethers (PBDEs), Bis(2-ethylhexyl) phthalate (DEHP), Butyl benzyl phthalate (BBP), Dibutyl phthalate (DBP) and Diisobutyl phthalate (DIBP)

Test Method : With reference to IEC 62321-4:2013+A1:2017, IEC 62321-5:2013, IEC 62321-7-1:2015 , IEC 62321-6:2015 and IEC 62321-8:2017, analyzed by ICP-OES , UV-Vis and GC-MS .

| <u>Test Item(s)</u> | <u>Limit</u> | <u>Unit</u> | <u>MDL</u> | <u>003</u> |
|-------------------------------|--------------|--------------------|------------|------------|
| Cadmium (Cd) | 100 | mg/kg | 2 | ND |
| Lead (Pb) | 1000 | mg/kg | 2 | 44 |
| Mercury (Hg) | 1000 | mg/kg | 2 | ND |
| Hexavalent Chromium (Cr(VI))▼ | - | µg/cm ² | 0.10 | ND |
| Sum of PBBs | 1000 | mg/kg | - | ND |
| Monobromobiphenyl | - | mg/kg | 5 | ND |
| Dibromobiphenyl | - | mg/kg | 5 | ND |
| Tribromobiphenyl | - | mg/kg | 5 | ND |
| Tetrabromobiphenyl | - | mg/kg | 5 | ND |
| Pentabromobiphenyl | - | mg/kg | 5 | ND |
| Hexabromobiphenyl | - | mg/kg | 5 | ND |
| Heptabromobiphenyl | - | mg/kg | 5 | ND |
| Octabromobiphenyl | - | mg/kg | 5 | ND |
| Nonabromobiphenyl | - | mg/kg | 5 | ND |
| Decabromobiphenyl | - | mg/kg | 5 | ND |
| Sum of PBDEs | 1000 | mg/kg | - | ND |
| Monobromodiphenyl ether | - | mg/kg | 5 | ND |
| Dibromodiphenyl ether | - | mg/kg | 5 | ND |
| Tribromodiphenyl ether | - | mg/kg | 5 | ND |
| Tetrabromodiphenyl ether | - | mg/kg | 5 | ND |



Unless otherwise agreed in writing, this document is issued by the Company subject to its General Conditions of Service printed overleaf, available on request or accessible at <http://www.sgs.com/en/Terms-and-Conditions.aspx> and, for electronic format documents, subject to Terms and Conditions for Electronic Documents at <http://www.sgs.com/en/Terms-and-Conditions/Terms-e-Documents.aspx>. Attention is drawn to the limitation of liability, indemnification and jurisdiction issues defined therein. Any holder of this document is advised that information contained hereon reflects the Company's findings at the time of its intervention only and within the limits of Client's instructions, if any. The Company's sole responsibility is to its Client and this document does not exonerate parties to a transaction from exercising all their rights and obligations under the transaction documents. This document cannot be reproduced except in full, without prior written approval of the Company. Any unauthorized alteration, forgery or falsification of the content or appearance of this document is unlawful and offenders may be prosecuted to the fullest extent of the law. Unless otherwise stated the results shown in this test report refer only to the sample(s) tested.

Attention: To check the authenticity of testing /inspection report & certificate, please contact us at telephone: (86-755) 8307 1443, or email: CN.Doccheck@sgs.com

Test Report

No. CANEC2218227003

Date: 30 Aug 2022

Page 3 of 8

| <u>Test Item(s)</u> | <u>Limit</u> | <u>Unit</u> | <u>MDL</u> | <u>003</u> |
|-------------------------------------|--------------|-------------|------------|------------|
| Pentabromodiphenyl ether | - | mg/kg | 5 | ND |
| Hexabromodiphenyl ether | - | mg/kg | 5 | ND |
| Heptabromodiphenyl ether | - | mg/kg | 5 | ND |
| Octabromodiphenyl ether | - | mg/kg | 5 | ND |
| Nonabromodiphenyl ether | - | mg/kg | 5 | ND |
| Decabromodiphenyl ether | - | mg/kg | 5 | ND |
| Dibutyl phthalate (DBP) | 1000 | mg/kg | 50 | ND |
| Butyl benzyl phthalate (BBP) | 1000 | mg/kg | 50 | ND |
| Bis (2-ethylhexyl) phthalate (DEHP) | 1000 | mg/kg | 50 | ND |
| Diisobutyl Phthalates (DIBP) | 1000 | mg/kg | 50 | ND |

Notes :

- (1) The maximum permissible limit is quoted from RoHS Directive (EU) 2015/863.
- (2) IEC 62321 series is equivalent to EN 62321 series
- (3) ▼= a. The sample is positive for CrVI if the CrVI concentration is greater than 0.13 µg/cm². The sample coating is considered to contain CrVI
 b. The sample is negative for CrVI if CrVI is ND (concentration less than 0.10 µg/cm²). The coating is considered a non-CrVI based coating
 c. The result between 0.10 µg/cm² and 0.13 µg/cm² is considered to be inconclusive - unavoidable coating variations may influence the determination
 Information on storage conditions and production date of the tested sample is unavailable and thus Cr(VI) results represent status of the sample at the time of testing.

Perfluorooctanoic acid (PFOA) and its salts & Perfluorooctane sulfonates (PFOS) and its derivatives

Test Method : With reference to CEN/TS15968:2010, analysis was performed by LC-MS or LC-MS/MS.

| <u>Test Item(s)</u> | <u>CAS NO.</u> | <u>Unit</u> | <u>MDL</u> | <u>003</u> |
|---|----------------|-------------|------------|------------|
| Perfluorooctanoic acid (PFOA) and its salts+ | 335-67-1 | mg/kg | 0.010 | ND |
| Perfluorooctane sulfonates (PFOS) ^ | 1763-23-1 | mg/kg | 0.010 | ND |
| Perfluorooctane Sulfonamide (PFOSA) | 754-91-6 | mg/kg | 0.010 | ND |
| N-methylperfluoro-1-octanesulfonamide(MeFOSA) | 31506-32-8 | mg/kg | 0.010 | ND |
| N-ethylperfluoro-1-octanesulfonamide (EtFOSA) | 4151-50-2 | mg/kg | 0.010 | ND |
| 2-(N-methylperfluoro-1-octanesulfonamido)-ethanol(MeFOSE) | 24448-09-7 | mg/kg | 0.010 | ND |
| 2-(N-ethylperfluoro-1-octanesulfonamido)-ethanol(EtFOSE) | 1691-99-2 | mg/kg | 0.010 | ND |
| Perfluorooctane sulfonates (PFOS) and its derivatives | - | mg/kg | - | ND |

Notes :



Unless otherwise agreed in writing, this document is issued by the Company subject to its General Conditions of Service printed overleaf, available on request or accessible at <http://www.sgs.com/en/Terms-and-Conditions.aspx> and, for electronic format documents, subject to Terms and Conditions for Electronic Documents at <http://www.sgs.com/en/Terms-and-Conditions/Terms-e-Document.aspx>. Attention is drawn to the limitation of liability, indemnification and jurisdiction issues defined therein. Any holder of this document is advised that information contained hereon reflects the Company's findings at the time of its intervention only and within the limits of Client's instructions, if any. The Company's sole responsibility is to its Client and this document does not exonerate parties to a transaction from exercising all their rights and obligations under the transaction documents. This document cannot be reproduced except in full, without prior written approval of the Company. Any unauthorized alteration, forgery or falsification of the content or appearance of this document is unlawful and offenders may be prosecuted to the fullest extent of the law. Unless otherwise stated the results shown in this test report refer only to the sample(s) tested.

Attention: To check the authenticity of testing /inspection report & certificate, please contact us at telephone: (86-755) 8307 1443, or email: CN.Doccheck@sgs.com

- (1) + PFOA and its salts including PFOA-Na (CAS No.: 335-95-5), PFOA-K (CAS No.: 2395-00-8), PFOA-Ag (CAS No.: 335-93-3), PFOA-F (CAS No.: 335-66-0) and APFO (CAS No.: 3825-26-1);
- (2) ^ PFOS including PFOS-K (CAS No.: 2795-39-3), PFOS-Li (CAS No.: 29457-72-5), PFOS-NH₄ (CAS No.: 29081-56-9), PFOS-NH(OH)₂ (CAS No.: 70225-14-8), PFOS-N(C₂H₅)₄ (CAS No.: 56773-42-3), PFOS-DDA(CAS No.:251099-16-8) and POSF (CAS No.: 307-35-7)

Unless otherwise stated, the decision rule for conformity reporting is based on Binary Statement for Simple Acceptance Rule ($w=0$) stated in ILAC-G8:09/2019.



Unless otherwise agreed in writing, this document is issued by the Company subject to its General Conditions of Service printed overleaf, available on request or accessible at <http://www.sgs.com/en/Terms-and-Conditions.aspx> and, for electronic format documents, subject to Terms and Conditions for Electronic Documents at <http://www.sgs.com/en/Terms-and-Conditions/Terms-e-Documents.aspx>. Attention is drawn to the limitation of liability, indemnification and jurisdiction issues defined therein. Any holder of this document is advised that information contained hereon reflects the Company's findings at the time of its intervention only and within the limits of Client's instructions, if any. The Company's sole responsibility is to its Client and this document does not exonerate parties to a transaction from exercising all their rights and obligations under the transaction documents. This document cannot be reproduced except in full, without prior written approval of the Company. Any unauthorized alteration, forgery or falsification of the content or appearance of this document is unlawful and offenders may be prosecuted to the fullest extent of the law. Unless otherwise stated the results shown in this test report refer only to the sample(s) tested.

Attention: To check the authenticity of testing /inspection report & certificate, please contact us at telephone: (86-755) 8307 1443, or email: CN.Doccheck@sgs.com

ATTACHMENTS

Pb/Cd/Hg/Cr⁶⁺/PBBs/PBDEs Testing Flow Chart

1) These samples were dissolved totally by pre-conditioning method according to below flow chart. (Cr⁶⁺ and PBBs/PBDEs test method excluded).

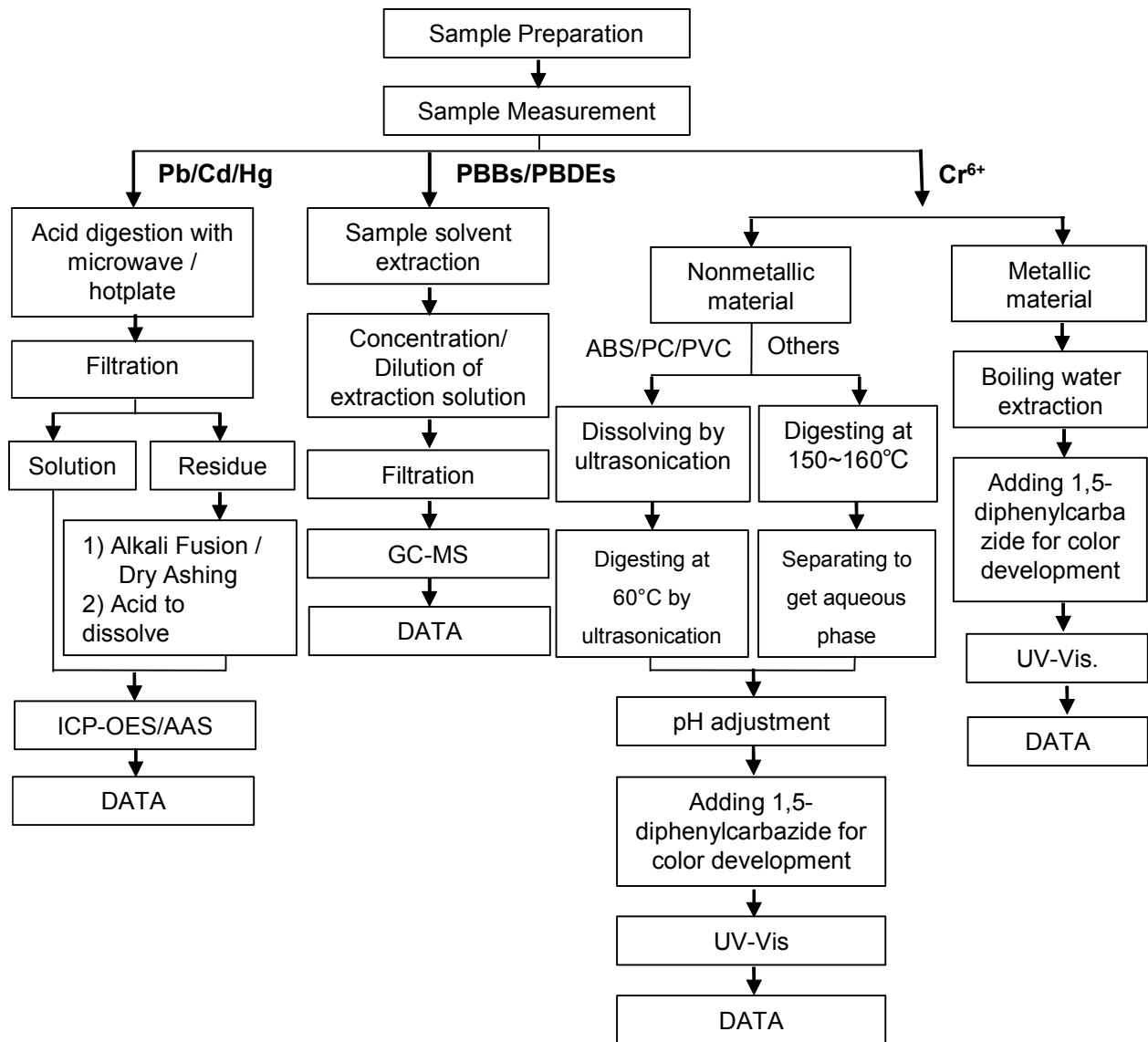

ATTACHMENTS

Phthalates Testing Flow Chart

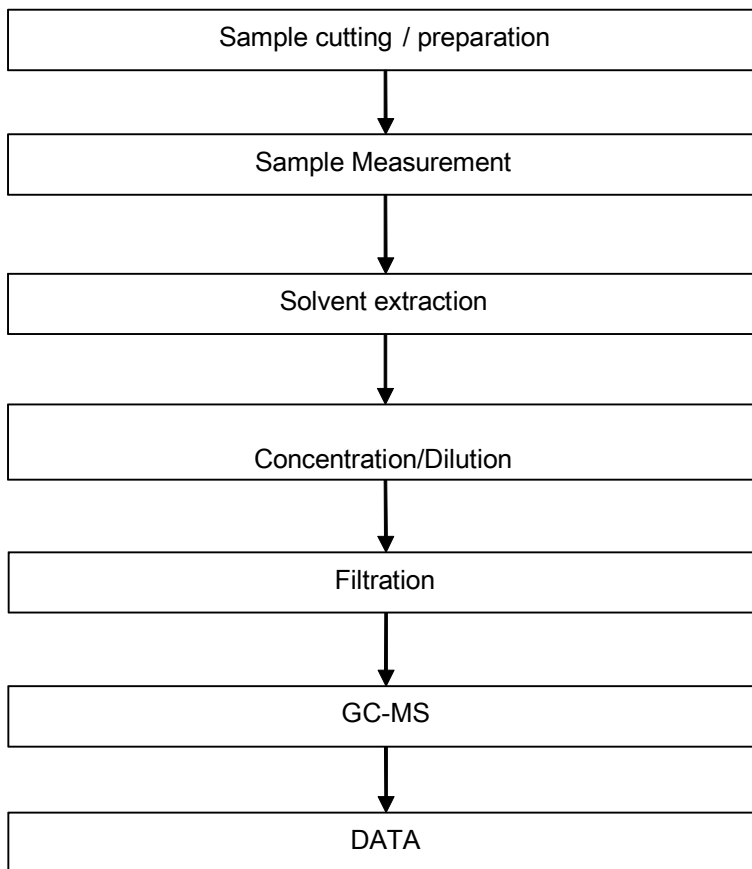

Unless otherwise agreed in writing, this document is issued by the Company subject to its General Conditions of Service printed overleaf, available on request or accessible at <http://www.sgs.com/en/Terms-and-Conditions.aspx> and, for electronic format documents, subject to Terms and Conditions for Electronic Documents at <http://www.sgs.com/en/Terms-and-Conditions/Terms-e-Document.aspx>. Attention is drawn to the limitation of liability, indemnification and jurisdiction issues defined therein. Any holder of this document is advised that information contained hereon reflects the Company's findings at the time of its intervention only and within the limits of Client's instructions, if any. The Company's sole responsibility is to its Client and this document does not exonerate parties to a transaction from exercising all their rights and obligations under the transaction documents. This document cannot be reproduced except in full, without prior written approval of the Company. Any unauthorized alteration, forgery or falsification of the content or appearance of this document is unlawful and offenders may be prosecuted to the fullest extent of the law. Unless otherwise stated the results shown in this test report refer only to the sample(s) tested.

Attention: To check the authenticity of testing / inspection report & certificate, please contact us at telephone: (86-755) 8307 1443, or email: CN_Doccheck@sgs.com

ATTACHMENTS

PFOA / PFOS Testing Flow Chart

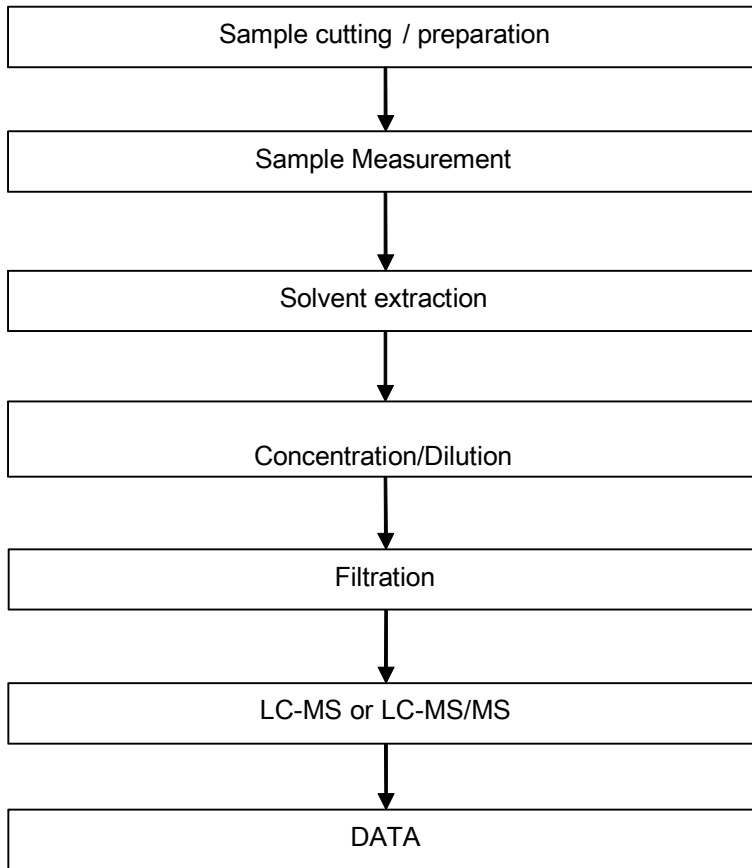

Unless otherwise agreed in writing, this document is issued by the Company subject to its General Conditions of Service printed overleaf, available on request or accessible at <http://www.sgs.com/en/Terms-and-Conditions.aspx> and, for electronic format documents, subject to Terms and Conditions for Electronic Documents at <http://www.sgs.com/en/Terms-and-Conditions/Terms-e-Document.aspx>. Attention is drawn to the limitation of liability, indemnification and jurisdiction issues defined therein. Any holder of this document is advised that information contained hereon reflects the Company's findings at the time of its intervention only and within the limits of Client's instructions, if any. The Company's sole responsibility is to its Client and this document does not exonerate parties to a transaction from exercising all their rights and obligations under the transaction documents. This document cannot be reproduced except in full, without prior written approval of the Company. Any unauthorized alteration, forgery or falsification of the content or appearance of this document is unlawful and offenders may be prosecuted to the fullest extent of the law. Unless otherwise stated the results shown in this test report refer only to the sample(s) tested.

Attention: To check the authenticity of testing / inspection report & certificate, please contact us at telephone: (86-755) 8307 1443, or email: CN.Doccheck@sgs.com

Sample photo:



SGS authenticate the photo on original report only

*** End of Report ***

