

REV.	ECH. NO.	APPD.
A	/	/

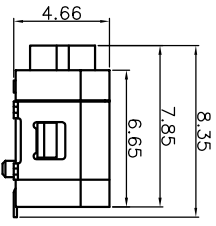

- NOTES:
SPECIFICATION:
- CURRENT RATING: 5A MAX
 - VOLTAGE: 100 VAC
 - TEMPERATURE RANGE: -40 ° C ~ 85 ° C
 - CONTACT RESISTANCE: 40 MILLIONHM MAX
 - INSULATION RESISTANCE: 100 MEGOHMS MIN.
 - INSERTION FORCE : 5N~20N
 - UNMATING FORCE: 8N~20N
 - DURABILITY: 10, 000 CYCLES
 - Water Resistance: IPXY7

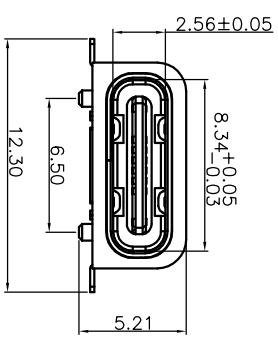
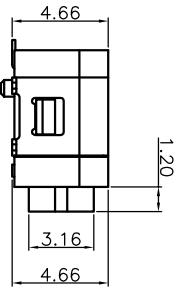
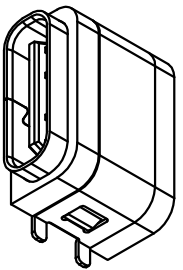
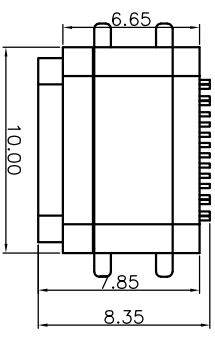
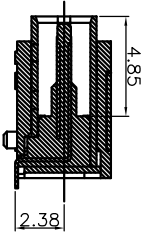
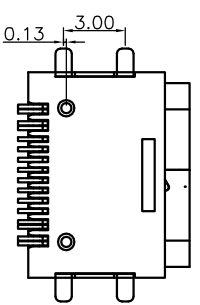
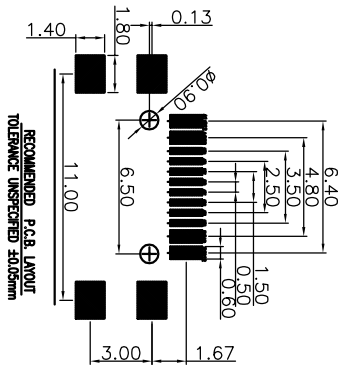
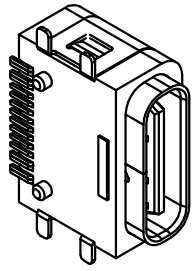

- U573-092X-XXXX0X8
- 1: 铁壳镀镍
 - 5: 铜壳镀镍
 - B: 不锈钢镀镍
 - 1: 半金1u"
 - 3: 半金3u"
 - 5: 半金5u"
 - 8: 半金15u"
 - 9: 镀全金1u"
 - G: 半金G/Fu"
 - 1: PA66
 - 2: PBT
 - 6: LCP
 - 1: 吸塑盒
 - 2: 吸塑管
 - 3: 载带
 - 6: 载带+贴麦拉
 - 1: 黑色
 - 2: 白色
 - 3: 米黄色

TOLERANCE UNLESS OTHERWISE SPECIFIED		HUA LIAN WEI TECHNOLOGY ELECTRONICS CO.,LTD.	
XXX ±0.10	X' ±3	HLW 深圳市华联威电子科技有限公司 HUA LIAN WEI TECHNOLOGY ELECTRONICS CO.,LTD.	
XX ±0.20	X' ±2		
X ±0.30	X' ±2	PART NAME:	TYPE C 16PIN SMT四脚全贴防水
APPROVED		PART NO:	U573-092B-G61018
CHECKED		PROJECTION:	
DRAWN	weihong	UNIT:	mm
DATE	2021.11.06	SCALE	1:1
		SHEET	10F1
		REV.	A